

LEASE AND USE AGREEMENT  
(2023-2033)

SAN FRANCISCO INTERNATIONAL AIRPORT

by and between the  
CITY AND COUNTY OF SAN FRANCISCO  
acting by and through its  
AIRPORT COMMISSION  
and

JAPAN AIRLINES CO., LTD.,  
a company formed under the laws of Japan

Mayor London N. Breed

AIRPORT COMMISSION  
Hon. Eleanor Johns, President  
Hon. Malcolm Yeung, Vice President  
Hon. Everett A. Hewlett, Jr.  
Hon. Jane Natoli  
Hon. Jose F. Almanza

Ivar C. Satero  
Airport Director

Lease No. 23-0035

## TABLE OF CONTENTS

DEFINITIONS.....	1
Section 1.1 Definitions.....	1
Section 1.2 Time Conventions.....	16
Section 1.3 Interpretation of Agreement.....	17
ARTICLE 2. PREMISES; USE.....	17
Section 2.1 Lease of Demised Premises; AS-IS Condition of Demised Premises.....	17
Section 2.2 Permitted Uses.....	18
Section 2.3 Prohibited Uses, Exclusions and Reservations.....	20
Section 2.4 Space Classifications.....	22
Section 2.5 Rights of Way.....	24
Section 2.6 Ingress and Egress.....	24
Section 2.7 Airline-Owned Equipment in Demised Premises.....	25
Section 2.8 Affiliate Airlines.....	25
ARTICLE 3. DETERMINATION OF COMMON USE GATES; ASSIGNMENT AND USE OF PREFERENTIAL USE GATES.....	26
Section 3.1 No Exclusive Use Gates; Swing Gates and Remote Gates are Common Use.....	26
Section 3.2 Resource Management Advisory Committee.....	26
Section 3.3 Annual Determination by the City of the Total Number of Common Use Gates and Allocable Gates.....	27
Section 3.4 Annual Determination of the Number of Preferential Use Gates to be offered to Eligible Signatory Airlines.....	27
Section 3.5 Location of Preferential Use Gates; Notice of Allocation of Preferential Use Gates; Acceptance or Rejection by Airlines.....	28
ARTICLE 4. RENTALS AND FEES.....	30
Section 4.1 Reports and Payments.....	30
Section 4.2 Rent and Usage Fees.....	31

<b>Section 4.3. Landing Fees.....</b>	<b>32</b>
<b>Section 4.4 Payment for Utilities.....</b>	<b>32</b>
<b>Section 4.5 Other Fees.....</b>	<b>32</b>
<b>Section 4.6 Payment Details.....</b>	<b>33</b>
<b>Section 4.7 Accounting.....</b>	<b>33</b>
<b>ARTICLE 5. ADJUSTMENT OF AIRLINE RATES AND CHARGES.....</b>	<b>33</b>
<b>Section 5.1 Periodic Review.....</b>	<b>33</b>
<b>Section 5.2 Method of Adjusting Terminal Area Rentals.....</b>	<b>34</b>
<b>Section 5.3 Method of Adjusting Landing Fees.....</b>	<b>36</b>
<b>Section 5.4 Review of Adjusted Rentals and Fees.....</b>	<b>38</b>
<b>Section 5.5 Reconciliation of Airline Rates and Charges and Application of Prior Period Deficits (Surpluses).....</b>	<b>38</b>
<b>Section 5.6 Operating Revenue and Capital Improvement Fund.....</b>	<b>39</b>
<b>ARTICLE 6. CAPITAL IMPROVEMENTS.....</b>	<b>40</b>
<b>Section 6.1 Financing of Capital Improvements.....</b>	<b>40</b>
<b>Section 6.2 Review of Capital Improvements.....</b>	<b>40</b>
<b>Section 6.3 Development of West of Bayshore Area.....</b>	<b>42</b>
<b>ARTICLE 7. RECAPTURE OF EXCLUSIVE USE SPACE; RELOCATION OF PREMISES; CITY ACCOMMODATION RIGHTS.....</b>	<b>43</b>
<b>Section 7.1 Recapture of Exclusive Use Space Following Any Reduction in Number of Preferential Use Gates.....</b>	<b>43</b>
<b>Section 7.2 Recapture of Exclusive Use Space Following Rejection of Preferential Use Gates by Airline.....</b>	<b>44</b>
<b>Section 7.3 Relocation of Airline Demised Premises and Operations.....</b>	<b>44</b>
<b>Section 7.4 Accommodation of Other Air Carriers in Airline’s Exclusive Use Space.....</b>	<b>46</b>
<b>Section 7.5. Accommodation of Other Air Carriers at Airline’s Preferential Use Gates.....</b>	<b>47</b>
<b>Section 7.6 Charges for Use of Preferential Use Gate by Another Air Carrier.....</b>	<b>48</b>
<b>Section 7.7 Charges for Use of Exclusive Use Facilities by Another Air Carrier.....</b>	<b>48</b>
<b>Section 7.8 Gate Accommodation Conditions.....</b>	<b>49</b>

ARTICLE 8. MISCELLANEOUS COVENANTS OF CITY .....	49
Section 8.1 Prudent Operation.....	49
Section 8.2 Revenues From Non-Airline Sources.....	49
Section 8.3 Airfield Area Users.....	49
ARTICLE 9. PIPELINES AND UTILITIES.....	49
Section 9.1 Reservations by City.....	49
Section 9.2 Relocation of Pipelines.....	50
Section 9.3 Information and Communications Technology; Utilities.....	50
ARTICLE 10. DEVELOPMENT, MAINTENANCE, AND OPERATION OF AIRPORT.....	50
Section 10.1 Operation of Airport.....	50
Section 10.2 Shared Use Equipment.....	51
Section 10.3 Self-Service Devices.....	51
Section 10.4 City-Owned Equipment; Maintenance Requirements and Operating Standards.....	52
Section 10.5 Condition of Demised Premises and Janitorial Services.....	52
Section 10.6 Airline Improvements.....	53
Section 10.7 Reporting of Damage to Airport Property.....	54
Section 10.8 Audit of Operations.....	54
Section 10.9 Trespass and Security.....	55
Section 10.10 Compliance with Applicable Laws.....	55
Section 10.11 Accessibility Disclosure.....	55
Section 10.12 Trash Removal.....	56
Section 10.13 Taxes.....	56
Section 10.14 Other Liens.....	56
Section 10.15 Air Carrier Consortia.....	57
ARTICLE 11. DAMAGE AND DESTRUCTION; CONDEMNATION .....	58
Section 11.1 Damage and Destruction.....	58

<b>Section 11.2 Condemnation/Eminent Domain</b> .....	<b>59</b>
<b>ARTICLE 12. RULES AND REGULATIONS</b> .....	<b>60</b>
<b>ARTICLE 13. NO OTHER CHARGES, QUIET ENJOYMENT</b> .....	<b>60</b>
<b>Section 13.1 No Other Charges</b> .....	<b>60</b>
<b>Section 13.2 Quiet Enjoyment</b> .....	<b>61</b>
<b>ARTICLE 14. LIMITED OBLIGATIONS, INDEMNITY, WAIVER AND INSURANCE</b> .....	<b>61</b>
<b>Section 14.1 Limited Obligations of City</b> .....	<b>61</b>
<b>Section 14.2 Indemnity, Waiver</b> .....	<b>61</b>
<b>Section 14.3 Public Liability and Property Damage Insurance</b> .....	<b>63</b>
<b>ARTICLE 15. SECURITY DEPOSIT</b> .....	<b>66</b>
<b>Section 15.1 Security for Faithful Performance</b> .....	<b>66</b>
<b>Section 15.2 Deposit/Faithful Performance Bond</b> .....	<b>66</b>
<b>ARTICLE 16. ASSIGNMENT AND SUBLETTING</b> .....	<b>68</b>
<b>Section 16.1 No Transfer</b> .....	<b>68</b>
<b>Section 16.2 Changes in Airline Ownership</b> .....	<b>68</b>
<b>Section 16.3 No Release</b> .....	<b>69</b>
<b>Section 16.4 Subleases</b> .....	<b>69</b>
<b>ARTICLE 17. TERMINATION OR SUSPENSION OF LEASE PROVISIONS</b> .....	<b>69</b>
<b>Section 17.1. Airline Events of Defaults and City Remedies</b> .....	<b>69</b>
<b>Section 17.2 Remedies</b> .....	<b>71</b>
<b>Section 17.3 City’s Right to Perform</b> .....	<b>72</b>
<b>Section 17.4 Rights Related to Termination</b> .....	<b>73</b>
<b>Section 17.5 Cumulative Rights</b> .....	<b>73</b>
<b>Section 17.6 Prepayment of Terminal Area Rentals/Landing Fees</b> .....	<b>73</b>
<b>Section 17.7 Fines</b> .....	<b>73</b>

<b>Section 17.8 Termination for Cessation of Use.....</b>	<b>74</b>
<b>Section 17.9 Waiver of Notice.....</b>	<b>74</b>
<b>Section 17.10 Annual Service Payments and City’s Right to Suspend Part of Agreement. ....</b>	<b>74</b>
<b>Section 17.11 Airline’s Right to Terminate. ....</b>	<b>77</b>
<b>ARTICLE 18. SURRENDER OF POSSESSION OF DEMISED PREMISES .....</b>	<b>77</b>
<b>Section 18.1 Surrender.....</b>	<b>77</b>
<b>ARTICLE 19. HOLDING OVER .....</b>	<b>78</b>
<b>Section 19.1 Month to Month.....</b>	<b>78</b>
<b>ARTICLE 20. CITY CONTRACTING PROVISIONS .....</b>	<b>79</b>
<b>Section 20.1 Nondiscrimination Ordinance.....</b>	<b>79</b>
<b>Section 20.2 Conflict of Interest.....</b>	<b>80</b>
<b>Section 20.3 Tropical Hardwoods and Virgin Redwoods. ....</b>	<b>80</b>
<b>Section 20.4 Drug-Free Workplace Policy.....</b>	<b>80</b>
<b>Section 20.5 Compliance with Americans with Disabilities Act and Air Carrier Access Act. ....</b>	<b>80</b>
<b>Section 20.6 Pesticide Prohibition.....</b>	<b>81</b>
<b>Section 20.7 MacBride Principles - Northern Ireland.....</b>	<b>81</b>
<b>Section 20.8 General Advertising Restrictions; Tobacco Products; Alcoholic Beverages.....</b>	<b>81</b>
<b>Section 20.9 First Source Hiring Ordinance. ....</b>	<b>82</b>
<b>Section 20.10 Local Hire. ....</b>	<b>82</b>
<b>Section 20.11 Sunshine Ordinance.....</b>	<b>82</b>
<b>Section 20.12 Charter Provisions.....</b>	<b>83</b>
<b>Section 20.13 Requiring Health Benefits for Covered Employees.....</b>	<b>83</b>
<b>Section 20.14 Requiring Minimum Compensation for Covered Employees. ....</b>	<b>84</b>
<b>Section 20.15 Notification of Limitations on Contributions.....</b>	<b>86</b>
<b>Section 20.16 Compliance with Laws. ....</b>	<b>86</b>
<b>Section 20.17 Airport Intellectual Property.....</b>	<b>86</b>

Section 20.18 Food Service Waste Reduction.....	87
Section 20.19 Labor Disputes.....	87
Section 20.20 Preservative-Treated Wood Containing Arsenic.....	87
Section 20.21 Vending Machines; Nutritional Standards and Calorie Labeling Requirements.....	87
Section 20.22 Reserved.....	88
Section 20.23 Resource-Efficient City Buildings.....	88
Section 20.24 All-Gender Toilet Facilities.....	88
Section 20.25 Reservation of Rights.....	88
ARTICLE 21. MISCELLANEOUS PROVISIONS.....	88
Section 21.1 No Individual Liability.....	88
Section 21.2 Agreements with Governments.....	88
Section 21.3 Governing Law; Venue.....	89
Section 21.4 Notices.....	89
Section 21.5 No Implied Waiver.....	89
Section 21.6 Federal Grant Agreement Covenants.....	90
Section 21.7 Contracting on More Favorable Terms.....	92
Section 21.8 Force Majeure.....	92
Section 21.9 Invalid Provisions and Severability.....	93
Section 21.10 Headings.....	93
Section 21.11 Exclusiveness of Airline’s Rights.....	93
Section 21.12 Withholding Required Approvals.....	93
Section 21.13 Majority-in-Interest Decisions.....	93
Section 21.14 Declaration Regarding Airport Private Roads.....	93
Section 21.15 Subordination of Agreement.....	94
Section 21.16 Inspection of Records.....	94
Section 21.17 Successors and Assigns.....	94

<b>Section 21.18 Taxes, Assessments and Liens.....</b>	<b>94</b>
<b>Section 21.19 Appendices, Exhibits and Schedules.....</b>	<b>95</b>
<b>Section 21.20 Entire Agreement.....</b>	<b>95</b>
<b>Section 21.21 Approvals.....</b>	<b>95</b>
<b>Section 21.22 Amendments. ....</b>	<b>96</b>
<b>Section 21.23 No Presumption Against Drafting Party. ....</b>	<b>96</b>
<b>Section 21.24 Duty Free Merchandise and International Travel Merchandise.....</b>	<b>96</b>
<b>Section 21.25 No Third-Party Beneficiaries. ....</b>	<b>96</b>
<b>Section 21.26 No Joint Venture. ....</b>	<b>96</b>
<b>Section 21.27 Nature of Agreement. ....</b>	<b>97</b>
<b>Section 21.28 Required Approvals. ....</b>	<b>97</b>
<b>Section 21.29 Airline Operations Information and Planning.....</b>	<b>97</b>
<b>Section 21.30 Waiver of Visual Artists Rights.....</b>	<b>98</b>
<b>Section 21.31 Airport Functions .....</b>	<b>98</b>
<b>Section 21.32 List of Pertinent Nondiscrimination Acts and Authorities. ....</b>	<b>98</b>
<b>Section 21.33 Federal Fair Labor Standards Act. ....</b>	<b>100</b>
<b>Section 21.34 OSHA. ....</b>	<b>100</b>
<b>Section 21.35 Electronic Signatures .....</b>	<b>100</b>
<b>ARTICLE 22. HAZARDOUS MATERIALS .....</b>	<b>100</b>
<b>Section 22.1 Airline’s Covenants. ....</b>	<b>100</b>
<b>Section 22.2 Access for Environmental Inspection. ....</b>	<b>101</b>
<b>Section 22.3 Liability. ....</b>	<b>102</b>
<b>Section 22.4 Environmental Indemnity. ....</b>	<b>102</b>
<b>Section 22.5 Environmental Audit.....</b>	<b>102</b>
<b>Section 22.6 Notice by Airline. ....</b>	<b>102</b>
<b>Section 22.7 Stormwater. ....</b>	<b>103</b>



<b>Section 22.8 Airline Obligations Upon Termination. ....</b>	<b>103</b>
<b>Section 22.9 Cumulative Remedies. ....</b>	<b>104</b>
<b>Section 22.10 Prior Agreements.....</b>	<b>104</b>
<b>ARTICLE 23. ENVIRONMENTAL SUSTAINABILITY .....</b>	<b>104</b>
<b>Section 23.1 General Sustainability Measures.....</b>	<b>104</b>
<b>Section 23.2 Sustainable Aviation Fuel Working Group.....</b>	<b>105</b>
<b>Section 23.3 Ground Service Equipment Electrification.....</b>	<b>105</b>
<b>ARTICLE 24. DIGITAL INFORMATION WORKING GROUP; AIRPORT DIGITAL ASSETS.....</b>	<b>105</b>
<b>Section 24.1 Digital Information Working Group. ....</b>	<b>105</b>
<b>Section 24.2 Commercialization of Airport Digital Assets.....</b>	<b>106</b>

## 2023-2033 LEASE AND USE AGREEMENT

### SUMMARY OF MAJOR TERMS

For the convenience of Airline and City (as such terms are defined below), this Summary of Major Terms (the “**Summary**”) summarizes certain terms of this Agreement (as defined below). The Summary is not intended to be a detailed or complete description of this Agreement and reference must be made to the Sections below for the particulars of this Agreement. In the event of any inconsistency between the terms of the Summary and any other provision of this Agreement, such other provision shall prevail. Capitalized terms used elsewhere in this Agreement and not defined elsewhere shall have the meanings given them in the Summary.

<b>Reference Date:</b>	_____
<b>Airline:</b>	Japan Airlines Co., Ltd., a company formed under the laws of Japan
<b>Airline’s Notice Address:</b> (§ 21.4)	300 Continental Boulevard, Suite 400 El Segundo, CA 90245 Attention: Linus J. Lee Title: Vice President, Operations, The Americas Phone: (310) 569-3608 Email: <a href="mailto:lee.sday@jal.com">lee.sday@jal.com</a>
<b>Airline’s Property Manager Address:</b>	300 Continental Boulevard, Suite 400 El Segundo, CA 90245 Attention: Linus J. Lee Title: Vice President, Operations, The Americas Phone: (310) 569-3608 Email: <a href="mailto:lee.sday@jal.com">lee.sday@jal.com</a>
<b>Airline’s Corporate Representative Address:</b> (§ 21.21)	P.O. Box 280025 San Francisco International Airport San Francisco, CA 94128-0025 Attention: Chikahiro Honda Title: Director, Administration Phone: (415) 265-3913 Email: <a href="mailto:honda.w8wn@jal.com">honda.w8wn@jal.com</a>
<b>City:</b>	The City and County of San Francisco, a municipal corporation, acting by and through its Airport Commission.



<b>Expiration Date:</b> <b>(§ 2.1)</b>	June 30, 2033, unless terminated earlier as provided herein.
<b>Deposit Amount:</b> <b>(§ 15.1)</b>	Two (2) months of Terminal Area Rentals, Landing Fees, usage fees, in the amounts set forth in the Airline Rates and Charges (as defined below), subject to adjustment as set forth below in <u>Article 15</u> .
<b>Commission Resolution authorizing Lease:</b> <b>(Recitals)</b>	Number 23-0035, approved by the Airport Commission on February 7, 2023.
<b>Board Resolution authorizing Lease:</b> <b>(Recitals)</b>	Number _____, approved by the City's Board of Supervisors on _____ and ratified by the Mayor on _____.
<b>Other agreement(s), if any:</b> <b>(§§ 17.1(x), 17.2(F), 15.1)</b>	Trash Compactor Use Permit No. 3535; Triturator Use Permit No. 3577.
<b>Exhibits:</b>	Exhibits A-R

## LEASE AND USE AGREEMENT

THIS LEASE AND USE AGREEMENT (this “**Agreement**”) is made and entered into as of the Effective Date by and between the CITY AND COUNTY OF SAN FRANCISCO (“**City**”), a municipal corporation acting by and through its AIRPORT COMMISSION (the “**Commission**”), and the AIRLINE identified in the foregoing Summary.

### RECITALS

A. City, acting by and through its Commission, owns and operates the San Francisco International Airport, which is located in the County of San Mateo, State of California. The Director is the Chief Executive Officer of the Airport.

B. Under the City Charter, Commission is charged with the management, supervision, operation, use, maintenance, extension, construction, and control of the Airport and is authorized to enter into all contracts, leases, permits, and agreements relating to matters within its jurisdiction and properties.

C. Airline desires to enter into this Agreement in order to operate at the Airport, and to lease and use certain space in one or more Terminals.

D. Pursuant to the Commission Resolution identified in the Summary, Commission has determined that entering into this Agreement is in the best interest of City and has authorized the execution of this Agreement. Pursuant to the Board Resolution identified in the Summary, the Board and the Mayor, each acting in their sole and absolute discretion, have determined that entering into this Agreement is in the best interest of City and have authorized the execution of this Agreement.

NOW, THEREFORE, in consideration of the foregoing and of the mutual covenants set forth herein, and other good and valuable consideration, receipt of which is hereby acknowledged, the parties do mutually agree as follows:

### ARTICLE 1. DEFINITIONS

**Section 1.1 Definitions.** The following words, terms, and phrases, wherever used in this Agreement, including this Section, shall for the purpose of this Agreement have the meanings respectively ascribed to them in this Section.

“**ACAA**” means the Air Carrier Access Act, 49 U.S.C. Section 41705, as amended and supplemented.

“**Access & Roadways Area Center**” means the Cost Center that includes all roadways and parkways, walks, bridges and culverts.

“**Activity Report**” means a monthly air traffic activity report submitted in accordance with Section 4.1(C) in substantially the form attached hereto as **Exhibit P**, as modified from time to time.

“**Acts and Regulations**” has the meaning given such term in Section 21.6(A).

“**ADA**” means, collectively, the Americans with Disabilities Act, 42 U.S.C. Sections 12101 et seq. and Title 24 of the California Code of Regulations, as amended and supplemented.

“**Additional Annual ORCIF Deposit**” means, for each Fiscal Year set forth in the table below, an amount not to exceed the amount set forth in the table below, as adjusted by the Index, commencing with Fiscal Year 2024-2025; provided, however, for the Fiscal Year 2024-25 and subsequent Fiscal Years, that the Additional Annual ORCIF Deposit for such Fiscal Year shall be less than or equal to the combined amount of (a) PFCs estimated to be designated and applied as Revenues for such Fiscal Year pursuant to the Master Bond Documents, and (b) any surplus from prior Fiscal Years’ Airline Rates and Charges (calculated pursuant to Section 5.5(A)) estimated to be applied to offset Airline Rates and Charges (pursuant to Sections 5.5(B) and 5.5(D)) for such Fiscal Year. For the avoidance of doubt, under no circumstances shall the Additional Annual ORCIF Deposit exceed the amounts set forth in the table below, as adjusted by the Index each year commencing with Fiscal Year 2024-2025:

<b>Fiscal Year</b>	<b>Additional Annual ORCIF Deposit</b>
2023-2024	\$250,000,000
2024-2025	\$70,000,000
2025-2026	\$60,000,000
2026-2027	\$50,000,000
2027-2028	\$40,000,000
2028-2029	\$30,000,000
2029-2030	\$25,000,000
2030-2031	\$25,000,000
2031-2032	\$0
2032-2033	\$0

“**Administration Area**” means the Revenue and AO&M Expense that are not directly chargeable to other Cost Centers, including, but not limited to costs associated with the overall administration of the Airport.

“**Administration Area Center**” means the Cost Center that includes the Administration Area.

“**Affiliate Airline**” means a non-Signatory Airline that is operating at the Airport under an Operating Permit with City and either (i) is a wholly owned subsidiary of a Signatory Airline, (ii) is a subsidiary of the same corporate parent of the Signatory Airline or (iii) shares flight codes with a Signatory Airline at the Airport, or (iv) operates cargo feeder flights at the Airport

under the direction and control of a Signatory Airline. Further, notwithstanding that a non-Signatory Airline may satisfy any of the criteria above, if such non-Signatory Airline is able to sell its own seats for flights at the Airport, it shall not be classified as an Affiliate Airline of any Signatory Airline.

“**Agreement**” means this Lease and Use Agreement.

“**Air Carrier**” means a carrier certificated by the Secretary of Transportation as a Passenger Carrier under 49 U.S.C. § 41102 or a Cargo Carrier under 49 U.S.C. § 41103 operating to or from the Airport.

“**Air Carrier Consortium**” means a consortium of Air Carriers operating at the Airport formed in accordance with the terms and conditions of Section 10.15 hereof for the purpose of providing Air Carrier Consortium Services pursuant to an agreement among the consortium and its member Air Carriers, provided that, once established pursuant to the terms of this Agreement, an Air Carrier Consortium shall be deemed to be and referred to as an “Existing Air Carrier Consortium” for purposes of Section 10.15 of this Agreement.

“**Air Carrier Consortium Requirements**” shall have the meaning provided in Section 10.15.

“**Air Carrier Consortium Services**” means the one or more operations, maintenance or other services to be performed at the Airport by an Existing Air Carrier Consortium or a new Air Carrier Consortium formed pursuant to Section 10.15 of this Agreement.

“**Airfield Area**” means all runways, taxiways, ramps, aprons, landing areas, adjacent infield areas, and related support facilities (e.g., perimeter dike, drainage pumping stations, field lighting, navigational aids, ARFF support facilities, fire and rescue watercraft, boathouses and related support facilities, and cart roads).

“**Airfield Area Center**” means the Cost Center that includes the entire Airfield Area.

“**Airfield Area Net Expense**” has the meaning given such term in Section 5.3(A).

“**Airline**” means the Air Carrier that is a party to this Agreement.

“**Airline Corporate Representative**” means a representative of Airline who is authorized to act on behalf of Airline, as specified in writing by Airline to City. The initial Airline Corporate Representative is identified in the Summary.

“**Airline Entity**” means Airline’s officers, contractors, employees, agents, representatives, licensees and/or invitees, and their successors and assigns; provided, however, that Airline Entity shall not include passengers.

“**Airline Leased Space**” means the Joint Use Space, Exclusive Use Space, and Preferential Use Space in the Terminal Area leased to any Signatory Airline.

“**Airline’s Notice Address**” means the address set forth in the Summary, or such other address as Airline may designate in writing to City.

“**Airline Rates and Charges**” means all Landing Fees and Terminal Area Rentals, inclusive of rentals and usage fees for Exclusive Use, Joint Use, and Preferential Use Space, as well as Common Use Facilities, paid by Signatory Airlines and Affiliate Airlines.

“**Airline’s Remediation**” has the meaning given such term in Section 22.8(B).

“**Airport**” means the San Francisco International Airport.

“**Airport Building Regulations**” means the building regulations applying to the construction, alteration, relocation, enlargement, replacement, repair, equipment, use and occupancy, location, maintenance, removal and demolition of every building or structure or any appurtenances connected or attached to such buildings or structures and any fire, life/safety, and security systems, potable water systems, and electrical systems under 600 volts within the geographical boundaries of the Airport, as amended from time to time. For reference, a copy of the Airport Building Regulations is attached to the Airport Rules and Regulations as Appendix F.

“**Airport Cost Accounting System**” means the system for collection, allocation, and reporting of revenues, expenses and Debt Service associated with the operation of the Airport in such a manner that will ensure the availability of proper data to support the calculation of Airline Rates and Charges required under this Agreement. The Airport Cost Accounting System for reporting revenues, expenses and Debt Service used by City will preserve the basic Cost Centers and shall be in accordance with Exhibit O which is incorporated herein by this reference.

“**Airport Proprietary Content**” has the meaning given such term in Section 24.2(B).

“**Airport Revenue Bonds**” means taxable and tax-exempt obligations authorized and issued, or to be issued, by City or for the benefit of Airport, including bonds, refunding bonds, notes, bond anticipation notes, commercial paper, lease or installment purchase agreements or certificates of participation therein, and other evidences of indebtedness, irrespective of priority of payment, the principal of, premium, if any, and interest on which are payable directly or indirectly from or secured in whole or substantial part by Revenues. Airport Revenue Bonds do not include Special Facility Bonds.

“**Airport Operations Bulletins**” means the notices of new or modified operational requirements for the Airport issued by the Director from time to time and applicable to tenants, permittees, licensees and other occupants of the Airport, or any of the foregoing.

“**Airport Security Directive**” means the notices of new or modified security requirements for the Airport issued by the Director from time to time and applicable to tenants, permittees, licensees and other occupants of the Airport, or any of the foregoing.

“**Airport Rules**” has the meaning given such term in Article 12.

“**Airport Rules and Regulations**” means the reasonable and not unjustly discriminatory rules and regulations as now or may hereinafter be adopted by the Commission from time to time.



“**Airport TI Guide**” means the Airport’s Airline Tenant Improvement Guide, as amended from time to time.

“**AirTrain Area**” means all areas of the AirTrain system including pedestrian bridges to Terminals and other facilities.

“**AirTrain Area Center**” means the Cost Center that includes the AirTrain Area.

“**Allocable Gate**” means a Domestic Contact Gate available for an Allocation Year in accordance with Section 3.3.

“**Allocation Review Period**” shall mean the nine (9) month review period occurring during the twelve (12) months prior to September 30th immediately preceding any allocation of Preferential Use Gates, but excluding the months of December, January and February during such period. An illustrative example of an Allocation Review Period is set forth in Exhibit J.

“**Allocation Year**” means March 1 of each year during the Term through the last day in February of the following year.

“**Alterations**” means the improvements installed by Airline at its expense in accordance with Section 10.3, including fixtures, furnishings, carpeting, decorations, finishings, equipment and all other improvements which Airline deems necessary for the use of the Demised Premises and which are not supplied by City.

“**Annual ORCIF Deposit**” has the meaning given such term in Section 5.6(B).

“**Annual Service Payment**” means a payment to City’s General Fund in accordance with Sections 5.2(B) and Section 17.10, or the equivalent amount determined in accordance with Section 17.10(C) and Section 17.10(E).

“**AO&M Expense**” has the meaning given such term in Exhibit O.

“**Applicable Laws**” means, collectively, all applicable present and future federal, state and local laws, rules, regulations, codes, ordinances, and judicial and regulatory orders, as they may be amended from time to time, whether foreseen or unforeseen, ordinary as well as extraordinary, including without implied limitation those relating to (i) health, sanitation and safety; (ii) the environment, including without limitation the Environmental Laws; (iii) access for persons with disabilities, including without limitation the Americans with Disabilities Act, 42 U.S.C. § 12101 et seq.; and (iv) airport security, including without limitation the regulations of the Transportation Security Administration, 49 CFR Parts 1540, 1542, 1544 et seq.

“**Basic Rate**” has the meaning given such term in Exhibit O.

“**Basic Rental Adjustment**” has the meaning given such term in Section 5.2(C)(v).

“**BICE**” means the Airport’s Building Inspection & Code Enforcement Division, and any division of the same.

“**Billing and Operational Information**” means any information that may be requested by City for the purposes of providing timely and accurate billing to Airline and improving Airport operations.

“**Board**” means City’s Board of Supervisors.

“**Capital Improvement**” means a single Airport addition or improvement, including equipment, which is purchased, leased or constructed at a cost of the Charge Trigger Amount or more, and has a useful life in excess of three (3) years.

“**Capped Index**” means the lesser of (i) the Index and (ii) four percent (4%) per annum.

“**CASp**” has the meaning given in Section 10.11.

“**CBP**” means the United States Customs and Border Protection Agency, together with any successor agency.

“**CFC Revenue**” has the meaning provided in Section 6.1(C).

“**Charge Trigger Amount**” means \$778,140 in Fiscal Year 2021/2022 dollars, as adjusted by the Index.

“**Check-In Counter Management Protocols**” means the check-in counter management protocols applicable to the IT or any DT, each as set forth in Exhibit G, as the same may be amended from time to time.

“**City**” means the City and County of San Francisco, a municipal corporation, acting by and through the Commission.

“**City Entity**” means City, Commission, its members, or any officers, agents, and employees of each of them, and their successors and assigns.

“**City Charter**” means that certain document, as amended from time to time, that grants City the legal authority to make and enforce all ordinances and regulations in respect to municipal affairs, subject only to the restrictions and limitations provided in that document.

“**City’s Notice Address**” means the address set forth in the Summary, or such other address as may be designated by City from time to time.

“**Commission**” means the Airport Commission of the City.

“**Common Use**” means the use of facilities or equipment made available by the City for use in common by one or more Air Carriers, each for a limited, designated period subject to payment of the applicable fees, if any, for such use.

“**Common Use Check-In Counters**” means the check-in counters as designated for Common Use, both in number and location, from time to time by the Director in accordance with Section 2.4(E).

“**Common Use Facilities**” means collectively, Common Use Gates, Common Use Support Facilities and Common Use Check-In Counters.

“**Common Use Gate Cap**” has the meaning given such term in Section 3.3(B).

“**Common Use Gate Domestic Operations Fee**” has the meaning provided in Section 4.2(F), as further illustrated in Exhibit F.

“**Common Use Gates**” means the Gates as designated, both in number and location, from time to time for Common Use by the Director in accordance with Article 3.

“**Common Use Support Facilities**” means the Support Facilities in the Terminals associated with the Common Use Gates or Common Use Check-In Counters as such Support Facilities are designated for Common Use, both in number and location, from time to time by the Director in accordance with Section 2.4(E).

“**Concession Revenues**” means (1) the fees and rentals earned by Commission acting on behalf of City for the right to provide and operate restaurants, bars, newsstands, gift shops, specialty shops, health clinics, advertising displays, insurance, public telephones and other merchandising concessions and consumer services in the Terminal Area; (2) the fees and rentals earned by Commission acting on behalf of City for the right to provide and operate courtesy vehicles, ground transportation services, car rental services, service stations and other concessions and services in the GT and Parking Area Center; (3) the fees and rentals earned by Commission acting on behalf of City for other activities and services in the GT and Parking Area Center such as public automobile parking and traffic fines; and (4) the fees and rentals earned by Commission acting on behalf of City for the right to provide hotel concessions in Other Leased Areas Center.

“**Contact Gate**” means any Gate equipped with a passenger loading bridge which may be attached directly to a parked aircraft.

“**Contingency Account**” means the account of that name established pursuant to the Master Bond Documents, funded with Revenues and other City moneys, the balance in which serves to satisfy a portion of the Debt Service coverage requirements under the Master Bond Documents.

“**Cost Centers**” means the functional areas of the Airport used to indicate the general geographic location of facilities and in accounting for revenues, expenses and Debt Service, consisting of the “Access & Roadways Area Center”, “Administration Area Center”, “Airfield Area Center,” “AirTrain Area Center”, “Terminal Area Center,” “GT and Parking Area Center,” “Other Leased Areas Center,” and “West of Bayshore Area Center,” as further described in the definition of each Cost Center and illustrated in Exhibit O.

“**Customer Facility Charge(s)**” means the charges implemented by City and collected by rental car companies operating at the Airport from their customers pursuant to the applicable provisions of California Government Code section 50474.3 and California Civil Code sections 1939.01 et seq., including any successor statutes.

“**Debt Service**” has the meaning given “Annual Debt Service” in the Master Bond Documents.

“**Deferred Aviation Revenue**” means the Deferred Aviation Revenue liability (or receivable, if appropriate), as further described in Section 5.5(A).

“**Demised Premises**” means the space leased by City to Airline on an Exclusive Use, Preferential Use, or Joint Use basis, all as more particularly described in the Summary and Exhibit D.

“**Deposit**” means Airline’s security deposit delivered in accordance with Article 15.

“**Deposit Amount**” means two (2) months of Terminal Area Rentals, Landing Fees and Usage Fees in the amounts established by the Commission in the Airline Rates and Charges (as adjusted from time to time), initially in the amount stated in the Summary and adjusted pursuant to Article 15.

“**Digital Information Working Group**” has the meaning given such term in Section 24.1.

“**Digital Signature**” means an electronic identifier, created by computer, intended by the party using it to have the same force and effect as the use of a manual signature.

“**Director**” means the Airport Director, the Chief Executive Officer of the Airport, or their designee.

“**Domestic Contact Gate**” means any Domestic Gate which is also a Contract Gate.

“**Domestic Gate**” means any Contact Gate or Remote Gate which is designated by the Director as inaccessible to the FIS.

“**Domestic Remote Gate**” means any Domestic Gate which is also a Remote Gate.

“**Domestic Operations**” means flight operations within the United States or to or from Canadian cities with CBP preclearance facilities, with the exception of United States territories which require FIS screening upon entry into the continental United States (e.g., Guam). References in this Agreement to “Domestic” shall refer to flights, passengers, activities, facilities, and equipment pertaining to Domestic Operations, as the context may require.

“**DT**” or “**Domestic Terminal(s)**” means Harvey Milk Terminal 1, Terminal 2 and Terminal 3, or any one of them, as the context may require.

“**Effective Date**” means the date on which this Agreement becomes effective, namely, the later of July 1, 2023 or the date on which the following conditions have been satisfied: (a) each party shall have executed two duplicate originals of this Agreement and provided the other party with a fully-executed original of the same; (b) the Commission, the Board and the Mayor, each acting in their sole and absolute discretion, shall have approved this Agreement and Airline shall have received evidence of the same; (c) Airline shall have obtained all necessary and appropriate corporate authorizations of this Agreement, and City shall have received evidence of the same; and (d) Airline shall have delivered the Deposit in accordance with Article 15 and all evidence of

insurance satisfactory to City in accordance with Article 14. The actual Effective Date is set forth in the Summary.

**“Eligible Signatory Airline”** means an Air Carrier that is a Signatory Airline which has averaged at least eight (8) departing Scheduled Operations per day during the Allocation Review Period for purposes of allocating Preferential Use Gates under Article 3.

**“Environmental Laws”** means any federal, state, local or administrative law, rule, regulation, order, permit, requirement or applicable and controlling federal and state court decisions relating to human health and safety, environmental conditions (including without limitation ground, air, water, or noise quality, pollution or contamination, and underground or above-ground tanks), or Hazardous Materials, whether now in effect or hereafter adopted or amended from time to time, including without limitation the Comprehensive Environmental Response, Compensation, and Liability Act (42 U.S.C. Section 9601, et seq.), the Resources Conservation and Recovery Act of 1976 (42 U.S.C. Section 6901, et seq.), the Clean Air Act (42 U.S.C. Section 7401, et seq.), the Clean Water Act (33 U.S.C. Section 1251, et seq.), the Safe Drinking Water Act (42 U.S.C. Section 300f, et seq.), the Hazardous Materials Transportation Act (49 U.S.C. Section 1801, et seq.), the Toxic Substances Control Act (15 U.S.C. Section 2601, et seq.); the California Hazardous Waste Control Law (California Health and Safety Code Section 25100, et seq.), the Porter-Cologne Water Quality Control Act (California Water Code Section 13000, et seq.), and the Safe Drinking Water and Toxic Enforcement Act (California Health and Safety Code Section 25249.5, et seq.).

**“Event of Default”** means each event listed in Section 17.1.

**“Exclusive Use Space”** means space in a Terminal leased or permitted to a single Air Carrier for its exclusive use.

**“Existing Air Carrier Consortium”** means an Air Carrier Consortium existing as of the Effective Date of this Agreement, which are (i) San Francisco Terminal Equipment Company, LLC, a Delaware limited liability company, (ii) SFO Fuel Company, LLC, a Delaware limited liability company. From and after the Effective Date, once an Air Carrier Consortium is established pursuant to Section 10.15 of this Agreement, it shall then be deemed to be an “Existing Air Carrier Consortium” for purposes of this Agreement.

**“Expiration Date”** means June 30, 2033, or such earlier date of termination of this Agreement as provided herein.

**“FAA”** means the Federal Aviation Administration or any successor agency.

**“FIS”** means the Federal Inspection Station located at the Airport for the processing of arriving international passengers.

**“First Notice”** has the meaning given such term in Section 17.1.

**“Fiscal Year”** means the twelve (12) month period commencing on July 1 and expiring on June 30 of each year.

“**FLSA**” has the meaning given such term in Section 21.33.

“**Gate**” means those portions of a Terminal individually comprised of a passenger holdroom, together with any or all of the following equipment, if present: a passenger loading bridge, a ground power unit, a pre-conditioned air unit, and related equipment. The related ramp (apron) is not included in the Gate but is retained by City and used by the Air Carrier using the related Gate.

“**Gate Management Protocols**” means the Gate Management Protocols for the Airport set forth in Exhibit H.

“**Gross Terminal Space**” means every square foot of interior space, covered ramp space and terrace spaces in the Terminal Area.

“**GT and Parking Area**” or “**Ground Transportation and Parking Area**” means all public parking lots, garages, service stations, shuttle bus service (non-airline), and rental car facilities.

“**GT and Parking Area Center**” means the Cost Center that includes the GT and Parking Area.

“**HAO**” has the meaning given such term in Section 20.25.

“**Hazardous Materials**” means (a) any material that, because of its quantity, concentration or physical or chemical characteristics, is deemed by any federal, state, or local governmental authority to pose a present or potential hazard to human health or safety or to the air, water or soil and (b) any materials, substances, products, byproducts, waste, or other materials of any nature or kind whatsoever whose presence in and of itself or in combination with other materials, substances, products, byproducts, or waste gives rise to liability under any Environmental Laws “**Hazardous Materials**” includes any material or substance identified, listed, or defined as a “hazardous waste,” “hazardous substance,” “pollutant,” “contaminant,” or term of similar import, or otherwise regulated pursuant to Environmental Laws; any asbestos and asbestos-containing materials; petroleum, including crude oil or any fraction thereof, natural gas or natural gas liquids..

“**HCAO**” has the meaning given such term in Section 20.13.

“**Information and Communications Technology**” means the information and communications technology (ICT) utilities, systems and devices provided by the Airport under Section 9.3 including, but not limited to, telephone, physical network infrastructure, wireless communications (both cellular and Wi-Fi), and cable television.

“**Index**” means the Implicit Price Deflator Index for Gross Domestic Product published by the U.S. Department of Commerce, Bureau of Economic Analysis, or its successor or replacement. The specific dollar cost figures throughout this Agreement are based upon Fiscal Year 2021/2022 dollars and shall be increased or decreased annually in proportion to changes in the Index using as a base the figure for the second quarter of 2021 (ending in June), which was 117.413 (index numbers, 2012=100; seasonally adjusted; and last updated on June 29, 2022.)

“**Integrated Pest Management**” or “**IPM**” has the meaning given such term in Section 20.6.

“**IPM Ordinance**” has the meaning given such term in Section 20.6.

“**International Operations**” means all flight operations other than Domestic Operations. References in this Agreement to “International” shall refer to flights, passengers, activities, facilities and equipment pertaining to International Operations, as the context may require.

“**IT**” or “**International Terminal**” means the portion of the Terminal Area, together with its connecting concourses, piers, boarding areas including extensions thereof, and satellite buildings, known individually as the International Terminal.

“**ITM**” shall have the meaning given such term in Section 21.24.

“**Joint Use Formula for Domestic Operations**” means the billing method applied to a specific area of Joint Use Space for Domestic Operations, attached as Exhibit E-2.

“**Joint Use Formula for International Operations**” means the billing method applied to a specific area of Joint Use Space for International Operations, attached as Exhibit E-1.

“**Joint Use Space**” means space in a Terminal that is leased or permitted for use by more than one Air Carrier with payments by the Air Carriers using such space calculated using the Joint Use Formula applicable to such space, as the same may be determined and/or modified from time to time by Director by written notice to affected Air Carriers.

“**Landing Fee Rate**” means the cents per thousand pounds of Maximum Landing Weight computed as provided in this Agreement, including Articles 4 and 5.

“**Landing Fees**” means the fees payable by the Signatory Airlines and their Affiliate Airlines as provided in this Agreement, including Articles 4 and 5.

“**Lease and Use Agreement**” means a Lease and Use Agreement substantially identical to this Agreement which is executed by a Signatory Airline.

“**LEED**” has the meaning given such term in Section 23.1.

“**Local Hiring Requirements**” has the meaning provided in Section 20.10.

“**Majority-in-Interest**” means more than fifty percent (50%) in number of the Signatory Airlines who, on the date in question, account for more than fifty percent (50%) of the aggregate weight for Revenue Aircraft Arrivals by the Signatory Airlines (including their respective Affiliate Airlines) at the Airport during the immediately preceding Fiscal Year.

“**Master Bond Documents**” means each resolution, ordinance, trust indenture or other document authorizing the issuance of Airport Revenue Bonds and prescribing the covenants and conditions attendant upon such issuance, including (a) Resolution No. 91-0210 adopted by the Commission on December 3, 1991, and (b) Resolution No. 97-0146 adopted by the Commission on May 20,

1997, each as amended and supplemented from time to time, or such successor resolutions not inconsistent with the provisions of this Agreement.

“**Maximum Annual ORCIF Deposit**” means, for any Fiscal Year, the sum of the Minimum Annual ORCIF Deposit and the Additional Annual ORCIF Deposit for such Fiscal Year.

“**Maximum Landing Weight**” means the maximum weight in thousand-pound units that an aircraft is authorized by the FAA to land at the Airport, as recited in the flight manual governing such aircraft.

“**MCO**” has the meaning given such term in Section 20.14.

“**Minimum Annual ORCIF Deposit**” means, for each Fiscal Year set forth in the table below, the amount set forth in the table below, as adjusted by the Capped Index commencing with Fiscal Year 2024-2025:

<b>Fiscal Year</b>	<b>Minimum Annual ORCIF Deposit</b>
2023-2024	\$0
2024-2025	\$25,000,000
2025-2026	\$25,000,000
2026-2027	\$25,000,000
2027-2028	\$25,000,000
2028-2029	\$30,000,000
2029-2030	\$30,000,000
2030-2031	\$30,000,000
2031-2032	\$30,000,000
2032-2033	\$30,000,000

“**Non-Airline Revenues**” means revenues of the Commission from sources other than Airline Rates and Charges, as illustrated in Exhibit O.

“**OEWD**” has the meaning given such term in Section 20.10.

“**Operating Permit**” means a thirty-day (30) revocable permit issued by City to an Air Carrier who is not a party to a Lease and Use Agreement, to use, together with others so authorized, the runways, taxiways, navigational aids, and other general use landing air facilities, for its aircraft landing and takeoffs required in connection with its operations to and from the Airport.

“**Operation and Maintenance Expenses**” has the meaning given such term in the Master Bond Documents.

“**ORCIF**” has the meaning given such term in Section 5.6(A).



**“Other Leased Areas”** means all areas and facilities which support airline functions (e.g., hangars, aircraft maintenance facilities, cargo facilities, fuel farms, flight kitchens), Airport support, and City/State/federal installations, fixed base operators, airline offices outside the Terminal Area, airline employee parking, Airport-maintained employee parking, Airport support facilities with related parking, sewage/waste treatment plants, detention ponds, Coast Guard, FAA, FBI, and other related facilities, hotels, and all leased and unleased land not included in another Cost Center.

**“Other Leased Areas Center”** means the Cost Center that includes all other Leased Areas.

**“Passenger Facility Charge”** or **“PFC”** means the fees authorized by 49 U.S.C. Section 40117 and regulated by 14 CFR Part 158 as such statute and regulations currently exist or as they may be amended during the Term of this Agreement.

**“Period of Use”** means (a) with respect to the use by a Signatory Airline (or its Affiliate Airline) of its Preferential Use Gate, the period of time with respect to a Scheduled Operation that such Signatory Airline is to use such Gate for a scheduled arrival and/or departure pursuant to the applicable Gate Management Protocols, (b) with respect to an Air Carrier’s use of a Gate that is not its Preferential Use Gate, the period of time that such Air Carrier is authorized to use such Gate for an aircraft arrival and/or departure pursuant to the applicable Gate Management Protocols, and (c) with respect to check-in counters and/or Support Facilities, the period of time that an Air Carrier is authorized to use such check-in counters and/or Support Facilities pursuant to the applicable Check-In Counter Management Protocols.

**“PFC Regulations”** has the meaning given such term in Section 13.1(B).

**“Pre-Existing Condition”** means the existence of any Hazardous Materials on the Demised Premises immediately prior to the date that Airline first took possession of the Demised Premises, including without limitation those conditions described in the reports listed in Exhibit M attached hereto that are applicable to the Demised Premises. A “Pre-Existing Condition” shall not include the existence of any Hazardous Materials caused or contributed to by the act or omission of Airline or any Airline Entity at any time, or any third party operating under the authority or control of Airline.

**“Preferential Use”** means with respect to a Gate, the scheduling preference over similar operations by another Air Carrier given to a Signatory Airline for the use of a Gate during applicable Periods of Use for such Signatory Airline’s Scheduled Operations.

**“Preferential Use Gate”** means a Gate assigned to a Signatory Airline for its Preferential Use in accordance with Article 3.

**“Preferential Use Space”** means the Terminal Area space leased by City to a Signatory Airline on a Preferential Use basis as provided in Article 3, and with respect to the Demised Premises leased to Airline, as described in Exhibit D.

**“Public Space”** means all Terminal Area space other than Airline Leased Space, including without limitation the space comprising Common Use facilities.

“**Release**” means any spilling, leaking, pumping, pouring, emitting, emptying, discharging, injecting, escaping, leaching, dumping, or disposing of Hazardous Materials onto property or into the environment. This includes the threat of a Release, to the extent such threat is regulated as a Release under applicable Environmental Laws.

“**Remote Gate**” means any Gate where an aircraft is not accessible directly from an associated holdroom via a passenger loading bridge, i.e., where the loading bridge, if present, does not interface directly with the door sill of the aircraft.

“**Rental Surcharge**” has the meaning given such term in Section 5.2(C)(iv).

“**Requesting Airline**” means an Air Carrier requesting the use of a Gate, other than its own Preferential Use Gate, if assigned, which could be a Common Use Gate or a Preferential Use Gate of another Signatory Airline.

“**Revenue Aircraft Arrival**” means each aircraft arrival at the Airport for which the applicable Air Carrier has received or made a monetary fee or charge, including flights which are diverted to the Airport because of mechanical, meteorological or other precautionary reasons; provided, however, that flights departing from the Airport and required to return to the Airport for such reasons shall not be considered Revenue Aircraft Arrivals.

“**Revenues**” has the meaning given such term in the Master Bond Documents.

“**RMAC**” or “**Resource Management Advisory Committee**” has the meaning given such terms in Section 3.2.

“**SAF Working Group**” has the meaning given such term in Section 23.2.

“**Scheduled Operation**” means an Air Carrier’s operation (arrival or departure) that occurs pursuant to a published schedule and uses the secured area of a Terminal.

“**Scheduled Operation Reports**” has the meaning given such term in Section 3.5(E).

“**Scheduled Seats**” means the total number of departing seats on the Scheduled Operations of a Signatory Airline (including its Affiliate Airlines) to destinations in the United States or Canada and on international flights allowed by City to depart regularly from a DT during the Allocation Review Period for which the determination under Section 3.4 is being made.

“**Scheduled Seats Percentage**” has the meaning given such term in Section 3.4(B).

“**SFAAAC**” means the San Francisco Airline-Airport Affairs Committee.

“**SFO Resource Management**” means City, in its capacity managing and allocating use of Gates, check-in counters, Facilities, and other related actions in accordance with the protocols set forth in Exhibit G and Exhibit H.

“**Shared Use Equipment**” means common use technology such as CUPPS, CUSS, iMUSE, CUTE and is the range of services, specifications, and standards enacted to enable multiple

airlines, service providers, or other users to share physical check-in or gate podium positions whether simultaneously or consecutively.

“**Signatory Airline**” means an Air Carrier, including Airline, that signs a Lease and Use Agreement.

“**Space Category(ies)**” shall mean the classification of the square footage attributable to the Airline Leased Space for the purpose of establishing Terminal Rental Rates, as set forth in Section 5.2(D) hereof.

“**Space Change Summary Notice**” means a notice in the form of Exhibit L. Each Space Change Summary Notice shall be deemed to form a part of this Agreement when executed by the parties and shall not require or constitute a formal amendment to this Agreement.

“**Special Facility Bonds**” means taxable and tax-exempt obligations issued by City or on behalf of Airport, including bonds, refunding bonds, notes, bond anticipation notes, commercial paper, lease or installment purchase agreements or certificates of participation therein and other evidences of indebtedness, the principal of, premium, if any, and interest on which are payable from or secured in whole or substantial part by revenues other than Revenues.

“**SSIM**” means Standard Schedules Information Manual.

“**State**” means the State of California.

“**Successor Lease and Use Agreement**” has the meaning given such term in Section 5.5(E).

“**Summary**” means the Summary of Major Terms set forth at the beginning of this Agreement.

“**Support Facilities**” means ticket office, outbound baggage makeup, inbound baggage makeup, baggage claim, and/or other support space.

“**Surcharge Rate**” has the meaning given such term in Exhibit O.

“**Swing Contact Gate**” means any Swing Gate that is also a Contact Gate.

“**Swing Gate**” means any Contact Gate or Remote Gate which is designated by the Director as accessible to the FIS. Swing Gates are also often referred to informally as “international gates,” although Swing Gates may be located in Domestic Terminals.

“**Swing Remote Gate**” means any Swing Gate which is also a Remote Gate.

“**T1**” means the portion of the Terminal Area, together with its connecting concourses, piers, boarding areas including extensions thereof, and satellite buildings, known individually as Harvey Milk Terminal 1.

“**T2**” means the portion of the Terminal Area, together with its connecting concourses, piers, boarding areas including extensions thereof, and satellite buildings, known individually as Terminal 2.

“**T3**” means the portion of the Terminal Area, together with its connecting concourses, piers, boarding areas including extensions thereof, and satellite buildings, known individually as Terminal 3.

“**Term**” means the period of time during which Airline’s activities at the Airport shall be governed by this Agreement, as set forth in the Summary. Said Term shall begin on the Effective Date and, except as otherwise set forth herein, shall terminate on the Expiration Date.

“**Terminal**” means, individually or collectively, as the case may be, T1, T2, T3 and the IT, together with any other terminals that may be constructed or designated at the Airport by City during the Term.

“**Terminal Area**” means all areas within the Terminals, including concourses, boarding areas, pedestrian bridges, tunnel lobbies to garages, mechanical/utility areas, lobbies, offices, Commission facilities, baggage facilities and storage areas.

“**Terminal Area Center**” means the Cost Center that includes all Terminal Areas.

“**Terminal Area Expenses**” has the meaning given such term in Section 5.2(A).

“**Terminal Area Rental(s)**” has the meaning given such term in Section 5.2(D).

“**Terminal Area Rental Rate(s)**” shall mean the rental rates established for Airline Leased Space classified according to Space Category by location and function, as calculated in accordance with Section 5.2(D).

“**Terminal Area Space**” means those categories of space used in the calculation of Terminal Area Rentals for the Signatory Airlines, as more particularly defined under “Gross Terminal Space,” “Airline Leased Space,” and “Public Space.”

“**Transfer**” means any assignment, encumbrance, subletting or other transfer, whether voluntary or involuntary or by operation of law.

“**TSA**” means the Transportation Security Administration, or any successor agency.

“**Virtual Advertisement**” means any advertisement projected virtually, including, but not limited to augmented reality, “green screen” overlays, and virtual reality.

“**West of Bayshore Area**” means all of the property located west of U.S. Highway 101 currently under the jurisdiction of the Commission as indicated on the map attached hereto as **Exhibit A**.

“**West of Bayshore Area Center**” means the Cost Center that includes the West of Bayshore Area.

**Section 1.2** Time Conventions. Every use of the term “day” shall refer to a calendar day unless otherwise specified; provided, however, that if the last day of any period to give notice, reply to a notice or to undertake any other action occurs on a Saturday, Sunday or a bank

or City holiday, the last day for undertaking the action or giving or replying to the notice shall be the next succeeding business day. Any reference to a time of day shall refer to the time of day at the Airport unless otherwise specified.

**Section 1.3** Interpretation of Agreement. Use of the word “including” or similar words shall not be construed to limit any general term, statement or other matter in this Agreement, whether or not language of non-limitation, such as “without limitation” or similar words, are used. Except as otherwise expressly provided, references to a “Section” or “Article” throughout this Agreement shall refer to those referenced provisions of this Agreement without needing to state “of this Agreement”, “hereof” or other similar wording.

## **ARTICLE 2. PREMISES; USE**

**Section 2.1** Lease of Demised Premises; Term; AS-IS Condition of Demised Premises.

A. City, as owner and operator of the Airport, shall and does hereby demise and let to Airline, and Airline shall and does hereby hire and take from City for the uses and purposes herein enumerated, the Demised Premises for use during the Term commencing on the Effective Date and expiring on the Expiration Date, on the terms and conditions set forth herein.

B. Upon at least seven (7) days’ written notice to Airline, Director may cause City to conduct a space audit pursuant to which City re-measures the Demised Premises using the Airport’s then-current measurement specifications, which space audit, shall only be conducted at reasonable times. Following such measurement and notice to Airline, the Demised Premises description and the rent shall be deemed adjusted per such measurement. Notwithstanding the foregoing, no rent adjustment shall be made retroactive in favor of either party for a period exceeding three (3) months. Airport measurement specifications as of the Effective Date are set forth in **Exhibit N**, attached hereto.

C. Airline acknowledges and agrees that (a) City shall have the right at all times to change, alter, expand, and contract the Airport; (b) City has made no representations, warranties, or covenants to Airline regarding the design, construction, pedestrian traffic, or views of the Airport or the Demised Premises; provided, however, that all such changes, alterations, expansions, and contractions, shall be subject to any consultation or approval requirements as may be described elsewhere in this Agreement. Without limiting the generality of the foregoing, Airline acknowledges and agrees that the Airport (i) is currently undergoing, and may from time to time hereafter undergo renovation, construction, and other Airport modifications; and (ii) may from time to time adopt Airport Rules relating to security and other operational concerns that may affect Airline’s business.

D. AIRLINE SPECIFICALLY ACKNOWLEDGES AND AGREES THAT ANY SPACE LEASED TO OR USED BY AIRLINE IS ON AN “AS IS WITH ALL FAULTS” BASIS AND THAT AIRLINE IS NOT RELYING ON ANY REPRESENTATIONS OR WARRANTIES OF ANY KIND WHATSOEVER, EXPRESS OR IMPLIED, FROM CITY OR ANY CITY ENTITY, AS TO ANY MATTERS CONCERNING SUCH SPACE.

**Section 2.2** Permitted Uses. Airline may use the Airport for all such operations and functions as are incidental, necessary or proper to the conduct of its air transportation business, including, but not limited to, the rights set forth below, provided the same are conducted subject to and in accordance with the conditions set forth in this Agreement, Applicable Laws and the Airport Rules; provided, however, that such rights shall not be construed as authorizing the conduct of a separate business by Airline, but shall permit Airline to perform such functions as are incidental to the conduct of air transportation:

- A. The use, with others so authorized, of the Airport and appurtenances, including the Terminal Area, the GT and Parking Area and the Airfield Area.
- B. The operation of an air transportation business for the carriage of persons, property, baggage, cargo, express, and mail, including, but without limiting the generality hereof, revenue, courtesy, test, training, inspection, emergency, charter and sightseeing flights.
- C. The repairing, maintaining, conditioning, servicing, testing, parking or storage of aircraft or other equipment operated by Airline or other Air Carriers.
- D. The hiring and training on the Airport of personnel in the employ of or to be employed by Airline, its contractors or other Air Carriers.
- E. The sale, disposal, or exchange of Airline's aircraft, engines, accessories, gasoline, fuel, or other propellants, oils, greases, lubricants, and other equipment or supplies, to permit Airline to perform such functions as are incidental to the conduct of its air transportation business, and specifically, but without limitation, to permit the sale or disposal of any article or goods used by, or bought for use by Airline in connection with its operation of an air transportation business; provided, however, that Airline may not sell gasoline, fuel, or other propellants, oils, greases, and other lubricants, to anyone other than a subsidiary, an affiliated company, other Signatory Airlines, other Air Carriers, or others for use in aircraft being used in connection with operations of Airline unless a particular grade is desired by others and is not otherwise available from concessionaires at the Airport.
- F. The servicing by Airline, or others, of Airline's aircraft and other equipment by truck or otherwise, with gasoline, fuel or other propellants, oils, greases, lubricants, or other supplies including foods and beverages required by Airline. Notwithstanding anything to the contrary herein, (i) Airline acknowledges that City has granted to SFO Fuel Company, LLC, an Air Carrier Consortium, the right to operate a fuel storage and delivery system serving the Airport, and may in the future grant similar rights to one or more parties which may be an Air Carrier Consortium; and (ii) Airline acknowledges and agrees that, to the extent it desires to receive distribution of jet fuel on Airport premises, it must receive such distribution from such party or parties, on the terms and conditions established by such party or parties. In no event will Airline have any right to operate a fuel storage and delivery system at the Airport, provided that Airline shall have the right to self-fuel in accordance with Applicable Laws and Airport Rules and Regulations.
- G. The landing, taking off, flying, taxiing, towing, parking, loading or unloading of Airline's aircraft, or the aircraft of any other Air Carrier.

H. The loading and unloading of property, cargo, express, and mail, and carriage of employees, in properly designated facilities, by such motor vehicles or other manner of conveyance as Airline may desire or require in the operation of an air transportation business, with the right to designate the Air Carrier(s) who shall regularly transport Airline's employees, property, cargo, express and mail to and from the Airport, subject to Subsection (O).

I. The use, alone or in conjunction with other Air Carriers as provided herein, of the Airport's Common Use facilities and the Demised Premises for any and all purposes in connection with and incidental to the operation of an air transportation business, including, without limiting the generality hereof, the handling of reservations, the handling, ticketing, billing and manifesting of passengers, baggage, express, cargo, property and mail, and the installation, maintenance and operation of radio and other communications equipment and facilities, meteorological and navigational equipment and facilities (subject to coordination with the Airport's radio service).

J. The preparation by Airline, or a subsidiary of Airline, of food and beverage service to be used in connection with the furnishing of air transportation by Airline or to provide in-flight food and beverage services for other Air Carriers and to engage in any activities related thereto. In addition, Airline or any subsidiary of Airline, may, within the confines of the Demised Premises leased to Airline hereunder and subject to the Director's prior written approval, operate passenger clubs and lounges in the Terminal Area, and to the extent permitted by Applicable Laws, serve and sell for purchase food and beverages in such passenger clubs and lounges. Notwithstanding the foregoing, for the avoidance of doubt, Airline shall not be permitted to provide food or beverage service in any other areas of the Airport, except in connection with emergency situations or irregular operations, or for employees in Exclusive Use Areas, in the reasonable determination of Director.

K. Subject to Section 10.6, including the prior written consent of Director, the installation, maintenance and operation, by Airline alone, or in conjunction with other Air Carriers, without cost to City, of a reasonable amount of suitable airplane air conditioning equipment, auxiliary power, start-up and other miscellaneous support equipment, which equipment shall be maintained and operated in accordance with the Airport Rules.

L. Subject to Section 10.6, including the prior written consent of Director, the installation and operation, at Airline's expense, of signs identifying the business of Airline, which signs shall be substantially uniform in size, type and location with those of other Air Carriers, the number, general type, size, design and location of such signs to conform to the Airport Rules (which for the avoidance of doubt, include the Airport TI Guide and the Airport Building Regulations).

M. The use of all public areas inside and outside the Terminal Area, which use shall be nonexclusive.

N. The purchase or other acquisition of services or personal property of any nature, including, but not limited to, gasoline, fuel, propellants, lubricating oil, greases, food, beverages and other materials, equipment and supplies deemed by Airline to be required by, or incidental to, Airline's operations, its exercise of the rights herein granted or its discharge of the

obligations herein imposed, from any person, partnership, firm, association, or corporation it may choose pursuant to licensing requirements established consistent with Article 12 and subject to Subsections (F) and (O).

O. Notwithstanding the foregoing provisions of this Section 2.2, City retains the right to regulate ground handlers and other service providers used by Airline, including, without limitation, the number and location of such handlers and servicers to ensure to the safe and efficient operation of the Airport. Airline is entitled to engage in its operations only those third-party ground handlers and service providers that are licensed or permitted by City to operate at the Airport. In the event Airline agrees to ground handle any portion of the operations of another Air Carrier (including for the avoidance of doubt, any Affiliate Airline), Airline shall provide City advance written notice of such proposed activities, including a description of the type and extent of services to be provided. Notwithstanding the foregoing, Airline shall not ground handle any Air Carrier which does not have the prior written consent of City to operate at the Airport.

**Section 2.3** Prohibited Uses, Exclusions and Reservations.

A. Airline shall not use or cause or permit any Airline Entity or others to use the Airport for any other purpose than specified under the terms and conditions of this Agreement. Without limiting the generality of the foregoing, Airline shall not do, cause or permit anything to be done in or about the Airport, or bring or keep anything thereon which will in any way:

- (i) increase the rate of fire insurance upon any areas of the Airport or any of its contents; or
- (ii) be unlawful or otherwise conflict with or violate Applicable Laws, subject to the right of Airline to contest the same in good faith as set forth in Article 12; or
- (iii) create a nuisance; or
- (iv) obstruct or interfere with the rights of other tenants at the Airport; or
- (v) commit or suffer to be committed any waste; or
- (vi) place any loads upon the floor, walls, or ceiling which endanger the structure; or
- (vii) obstruct the sidewalk or passageways or stairways or escalators; or
- (viii) be unlawful.

B. Airline shall not knowingly interfere or permit interference with the use, operation, or maintenance of the Airport, including, but not limited to, the effectiveness or



accessibility of the drainage, sewerage, water, communications, fire protection, utility, electrical or other systems installed or located from time to time at the Airport.

C. As soon as possible after release from proper authorities, Airline shall remove any of its disabled aircraft from the airfield or aprons, shall place any such disabled aircraft only in such storage areas as may be reasonably designated by the Director, and shall store such disabled aircraft only upon such terms and conditions as may be reasonably established by City. In the event Airline shall fail to remove any of its disabled aircraft as expeditiously as possible, City may, after at least two (2) days written notice, but shall not be obligated to, cause the removal of such disabled aircraft. Airline shall pay to City, upon receipt of an invoice, the costs incurred for such removal plus fifteen percent (15%).

D. Airline shall not do or permit to be done anything, either by act or failure to act, that shall cause the cancellation or violation of the provisions, or any part thereof, of any policy of insurance for the Airport or that shall cause a hazardous condition so as to increase the risks normally attendant upon operations permitted by this Agreement. If Airline shall do or permit to be done any act not permitted under this Agreement or fail to do any act required under this Agreement, which act or failure, in and of itself, causes an increase in City's insurance premiums, Airline shall immediately remedy such actions upon notice from City to do so.

E. City may install or cause to be installed advertising and revenue generating devices, including vending machines, in Joint Use Space and Preferential Use Space in the Demised Premises; provided, however, that City shall not install or cause to be installed in Airline's Preferential Use Space advertising (i) for Airline's direct competitors or (ii) immediately adjacent to Airline's identifying sign (and Airline agrees not to place its identifying sign in a location immediately adjacent to Airport's established advertising locations). Airline shall purchase all advertising for any product or service other than air service arriving at or departing from the Airport from the Airport's advertising concessionaire. Any revenue generated by advertising installed on Airline-owned equipment shall be shared by City and Airline as shall be mutually agreed. City may also, at its sole option, install Information and Communications Technology in any part of the Terminals excluding Airline's clubs and lounges. City shall be entitled to reasonable access to the Demised Premises so as to install or service such Information and Communications Technology. Income generated by such Information and Communications Technology shall be accounted for in the same manner as other Non-Airline Revenues of the Airport.

F. Except as permitted or authorized by applicable Environmental Laws or discharge requirements issued by the Airport or included in the Airport Rules, Airline shall not dispose of nor permit any other person to dispose of any waste material into the sanitary or storm sewers at the Airport or elsewhere (whether liquid or solid) unless such waste materials or products are first properly treated. Nothing herein shall prohibit Airline from disposing of human waste taken from its aircraft in proper designated sanitary sewer facilities.

G. Except as otherwise expressly permitted in this Agreement, Airline shall not use the Demised Premises or any virtual representation thereof for providing by sale or otherwise of foods or beverages or for the operation of sales, services, or concession stands of

any kind or for the furnishing, display or selling of insurance, banking, car rental, money exchanging, advertising, or other commercial service.

H. Any and all rights and privileges not specifically granted to Airline for its use of and operations at the Airport pursuant to this Agreement are hereby reserved for and to City. City may enter upon the Demised Premises at any and all reasonable times and upon reasonable written or electronic mail notice of not less than forty-eight (48) hours (except in emergency situations, which are addressed below) to inspect the same for the purpose of determining whether or not Airline is complying with the terms and conditions of this Agreement or for any other purpose incidental to the rights of the City; provided that such right of entry does not unreasonably interfere with Airline's operations. In the case of an emergency, the City shall provide as much notice as reasonably possible in light of the circumstances. In the event such inspection shows that Airline is not in compliance with the terms and conditions of this Agreement, without limiting any other remedy hereunder, City may require that Airline reimburse City for the costs of such inspection. Airline shall promptly remedy any noncompliance shown in any such inspection.

**Section 2.4** Space Classifications. For purposes of rent allocations, fees and billing, all space is either deemed Joint Use Space, Exclusive Use Space, Preferential Use Space, Public Space or Common Use Facilities, and shall have the following characteristics:

A. Joint Use Space.

(i) Airline shall be entitled to use the Joint Use Space included in the Demised Premises with others so authorized, subject to the provisions of Subsections 2.4(A)(iii), (iv) and (v) below.

(ii) Rent on Airline's Joint Use Space shall be based on the Joint Use Formula applicable to such portion of the Joint Use Space.

(iii) If the Demised Premises include check-in counters and other resources used by more than one Air Carrier within Joint Use Space, Airline shall be entitled to use the same with others so authorized. Such check-in counters and resources shall be managed and assigned by City to Airline for priority use based on the Management Protocols for Joint Use, Common Use and Shared Use Equipment. In determining Airline's need, City shall include the needs of Air Carriers being handled at such check-in counters and resources by Airline. When Airline is not using the assigned check-in counters and resources, other Air Carriers may use some or all of the same, in accordance with the Management Protocols for Joint Use, Common Use and Shared Use Equipment. In the event that an Air Carrier Consortium shall be responsible for arranging such use, then such use shall still be based on the Management Protocols for Joint Use, Common Use and Shared Use Equipment, and the applicable Air Carrier Consortium shall inform City of such arrangements with such frequencies as the parties shall determine. City shall have the right to oversee and reasonably object to such arrangements or practices. In such event, the Air Carrier Consortium shall revise its practices to satisfy City's objection. For the avoidance of doubt, City or its contractor or manager shall manage the check-in counters and resources within the Joint Use Space in

accordance with the Management Protocols for Joint Use, Common Use and Shared Use Equipment during any period of time when there is no Air Carrier Consortium under contract to provide such services.

(iv) If the Demised Premises include Gates within Joint Use Space, Airline shall be entitled to use such Gates with others so authorized. Such Gates shall be managed and assigned by City to Airline for priority use based on the Gate Management Protocols, which assignments are subject to City's approval, not to be unreasonably withheld. In determining Airline's need, City shall include the needs of Air Carriers being handled at such Gates by Airline. When Airline is not using the assigned Gates, other Air Carriers may use some or all such Gates, in accordance with the Gate Management Protocols. In the event that an Air Carrier Consortium shall be responsible for arranging such use, then such use shall still be based on the Gate Management Protocols, and the applicable Air Carrier Consortium shall inform City of such arrangements with such frequencies as the parties shall determine. City shall have the right to oversee and reasonably object to such arrangements or practices. In such event, the Air Carrier Consortium shall revise its practices to satisfy City's objection. For the avoidance of doubt, City or its contractor or manager shall manage the Gates within the Joint Use Space in accordance with the Gate Management Protocols during any period of time when there is no Air Carrier Consortium under contract to provide such services.

(v) Other Joint Use Space in the Terminals may be managed by City, its designated resource manager, or by one or more Air Carrier Consortia, in accordance with management protocols, including the Management Protocols for Joint Use, Common Use and Shared Use Equipment and Gate Management Protocols, as applicable. Director shall have the right to reasonably designate and modify Joint Use Space in the Terminal Areas from time to time by written notice to the affected Air Carriers. If Director elects to treat an area in the Terminal Areas as Joint Use Space, City may establish or designate the necessary management protocols and Joint Use Formulas in consultation with the Air Carriers that will use such Joint Use Space and any City designated resource manager or the one or more Air Carrier Consortia that will manage such Joint Use Space.

B. Exclusive Use Space. Airline shall have the exclusive right to occupy and use all Exclusive Use Space included in the Demised Premises. Rent for all Exclusive Use Space shall be based on the Airline Rates and Charges, as calculated pursuant to this Agreement. Notwithstanding anything in this Agreement to the contrary, holdrooms associated with Preferential Use Gates are not Exclusive Use Space.

C. Preferential Use Space. Airline shall be entitled to use Preferential Use Space included in the Demised Premises with others authorized in accordance with the provisions of Article 3. Rent for all Preferential Use Space shall be based on the Airline Rates and Charges, as calculated pursuant to this Agreement.

D. Public Space. All space designated as Public Space shall be available for use by Airline (other than space leased or permitted to, or used by, other tenants or parties) within the Terminal Area in common with others so authorized in accordance with the provisions of this Agreement and the Airport Rules; provided, however, that Airline shall make

commercially reasonable efforts to encourage Airline employees to use Airline's Exclusive Use Space or other space designated by City, rather than Public Space, for employee breaks.

E. Common Use Facilities; City Control and Designation During the Term.

(i) City may periodically and reasonably designate portions of the Public Space for Common Use Facilities. The City shall retain exclusive control of the use of all Common Use Facilities, except to the extent that any such Common Use Facilities may be managed by an Air Carrier Consortium pursuant to Section 10.15. Airline's use of Common Use Facilities shall be subject to the Gate Management Protocols and Check-In Counter Management Protocols, as applicable.

(ii) During the Term, if in the Director's reasonable discretion an adjustment to the location or number of Common Use Check-In Counters and Common Use Support Facilities would be desirable, the Director may designate for Common Use additional check-in counters and Support Facilities. The Director may also change Common Use Check-In Counters and Common Use Support Facilities from Common Use to Joint Use or Exclusive Use for lease to Signatory Airlines.

(iii) Fees for the use of Common Use Facilities shall be established by City as part of the Airline Rates and Charges and calculated in accordance with the applicable provisions of this Agreement.

(iv) Notwithstanding the foregoing, the number and location of Common Use Gates shall be determined by Director in accordance with Article 3.

**Section 2.5** Rights of Way. Airline shall have the use and enjoyment of suitable rights of way in the Terminal(s) where the Demised Premises are located to install and maintain facilities necessary to Airline's air transportation operations, except that Airline shall not be entitled to any such rights of way for any function provided or available to Airline through City or an Airline Consortium, but only if such Airline Consortium has been granted an exclusive by City. Airline shall have the use and enjoyment of suitable rights of way over, under and upon the apron areas adjacent to the Demised Premises for the purpose of enabling Airline, at its own expense, to install and maintain underground conduits, ducts, pipes, wires and incidental pumps, motors, tanks, filters and other equipment which are or may be necessary or convenient in connection with the supply of power, airstart, and other services to Airline's aircraft, provided that such right(s) of way shall not be in competition with the exclusive fuel system described in Section 2.2(F) of this Agreement. The location or locations of said rights of way and installations therein shall be subject to the prior written approval of Director. The use and enjoyment of said rights of way shall not be subject to any charge whatsoever by City to Airline. Notwithstanding anything to the contrary herein, Airline shall have no such right(s) of way for any telecommunications systems, except and to the extent the same is consistent with the Airport's telecommunications policies and programs in place and amended from time to time.

**Section 2.6** Ingress and Egress. Subject to Airport Rules and Applicable Laws, including, without limitation, applicable federal security regulations, City hereby grants to Airline the following rights and privileges of ingress and egress at the Airport:

A. For Airline and each Airline Entity: to the public areas of the Airport and to those areas and facilities designated herein for use by Airline. This right shall extend to aircraft, vehicles, machinery, and equipment used by or for the benefit of Airline in its air transportation business.

B. For Airline's passengers, guests and invitees: to areas leased exclusively, jointly or preferentially to Airline and to public areas and public facilities. This privilege shall extend to vehicles of such passengers, guests and invitees.

C. For Airline's vendors, suppliers of materials and furnishers of service: to the public areas of the Airport and to areas and facilities leased to or designated herein for use by Airline. This privilege shall extend to vehicles, machinery and equipment of such vendors, suppliers and furnishers of services used in their business of furnishing such supplies and services to Airline; provided, however, that Commission may require any such vendor, supplier and furnisher of service to enter into a permit to operate at the Airport and impose a charge upon Airline's suppliers or furnishers of service in an amount sufficient to recover the costs incurred in the reasonable regulation by Commission of such suppliers or furnishers of service in the exercise by them of the foregoing right of ingress and egress.

D. The full and free right of ingress and egress provided for above shall not be used, enjoyed or extended for any purpose or use in contravention of the provisions of Section 2.2 hereof unless expressly authorized in writing in advance by Director. When reasonably required for reasons of safety or security, Director may limit access to any area within the Airport.

**Section 2.7** Airline-Owned Equipment in Demised Premises.

A. If Airline leased space in one or more of the Domestic Terminals prior to the Effective Date of this Agreement, any equipment or trade fixtures (including without limitation passenger loading bridges and baggage handling systems) owned by Airline located in such space shall be treated as follows:

(i) If the previously leased space where such equipment or trade fixtures are located remains in the Demised Premises under this Agreement, City and Airline agree that such equipment or trade fixtures may remain in the Demised Premises under Airline ownership subject to the provisions of this Agreement.

(ii) If the previously leased space where such equipment or trade fixtures are located is not included in the Demised Premises under this Agreement, Airline shall remove such equipment or trade fixtures in accordance with Article 18 prior to surrendering such previously leased space, unless City and Airline shall have made alternate arrangements.

B. Reserved.

**Section 2.8** Affiliate Airlines. A Signatory Airline may designate one or more Affiliate Airlines by submitting documentation sufficient to demonstrate to the satisfaction of the

Director that the conditions of this Section have been met. Each Affiliate Airline shall execute an agreement with City substantially in the form of an Operating Permit prior to operating at the Airport. Airline shall provide City with thirty (30) days prior written notice before designating an Affiliate Airline. This Agreement and such written notice shall constitute an agreement by Airline to guarantee and be responsible for performing all obligations hereunder on behalf of its Affiliate Airline(s), including, without limitation, all reporting obligations, and paying all amounts to be due to City from Affiliate Airline under this Agreement. If an Air Carrier is an Affiliate Airline of more than one Signatory Airline, the guaranty of each such Signatory Airline shall include only the payment and reporting obligations in connection with the flight operations of the Affiliate Airline related to such Signatory Airline. Airline's designation of any Affiliate Airline shall be subject to City's approval, which approval shall not be unreasonably withheld provided that Airline has notified City in the manner required above. Airline shall provide City with thirty (30) days prior written notice before the cancellation or modification of any designation of an Affiliate Airline. Regardless of the timing of any such written notice, an Affiliate Airline's status shall terminate automatically at such time as the Affiliate Airline ceases to satisfy the criteria that allowed it to qualify as an Affiliate Airline hereunder. An Affiliate Airline shall have no Majority-in-Interest voting rights, but shall be included with its Signatory Airline's Revenue Aircraft Arrivals for purposes of determining a Majority-in-Interest.

### **ARTICLE 3. DETERMINATION OF COMMON USE GATES; ASSIGNMENT AND USE OF PREFERENTIAL USE GATES**

**Section 3.1** No Exclusive Use Gates; Swing Gates and Remote Gates are Common Use.

A. Gates will be allocated to Signatory Airlines as Preferential Use Gates or will be made available by City for use by an Air Carrier, including a Signatory Airline, as a Common Use Gate. No Gates will be leased or permitted to any Air Carrier on an Exclusive Use basis.

B. Use of any Gate shall, at all times, be subject to the Gate Management Protocols applicable to such Gate. City reserves the right to remove Gates from active use, following consultation with the RMAC (as defined below) and SFAAAC.

C. All Swing Gates and Remote Gates are Common Use, shall be assigned on only on a Common Use basis and are not Allocable Gates. Only Domestic Contact Gates may be Allocable Gates.

**Section 3.2** Resource Management Advisory Committee. The Director shall establish a committee composed of three (3) representatives designated by City and three (3) representatives of the Signatory Airlines designated by the SFAAAC (the "**Resource Management Advisory Committee**" or "**RMAC**") to review and make recommendations to City about the numbers of Gates to be reserved for use as Common Use Gates during any Allocation Year and about the locations within the Terminals of Common Use Gates and Preferential Use Gates. The RMAC shall consider both the operational efficiency from the perspectives of City, the Signatory Airlines and any non-Signatory Airlines, and the customer service implications of its recommendations. The final recommendations of the RMAC shall be

advisory only, and all final determinations of the Director hereunder shall be made by the Director in the Director's sole discretion. The Director shall also have the sole discretion, after taking into consideration any recommendations by the RMAC, to suspend any reallocation of Common Use Gates and Preferential Use Gates for one additional Allocation Year.

**Section 3.3** Annual Determination by the City of the Total Number of Common Use Gates and Allocable Gates.

A. No later than November 1, 2024, and then annually on November 1 of each Allocation Year thereafter during the Term, City shall present to the RMAC for review and discussion a preliminary plan indicating the number of Allocable Gates in each Terminal proposed to be reserved for use as Common Use Gates in the following Allocation Year. Subject to the Common Use Gate Cap, the Director shall have sole discretion, after taking into consideration any recommendations by the RMAC, which such recommendations shall be due to Director no later than November 20, 2024, and then annually on November 20 of each Allocation Year thereafter during the Term, to determine the total number of Allocable Gates to be reserved as Common Use Gates, with the first determination and effective date not occurring until March 1, 2025, and then annually on March 1 of each Allocation Year thereafter during the Term, subject to the Director's right to suspend the reallocation of Gates for one additional Allocation Year pursuant to Section 3.2. The Allocable Gates remaining available for use after such determination shall be offered by City to Eligible Signatory Airlines for use as Preferential Use Gates to be allocated in accordance with Section 3.4 (such amount of Allocable Gates being the "**Allocable Preferential Use Gate Number**"). City shall notify in writing all Signatory Airlines of its determination with respect to Common Use Gates no later than December 10, 2024, and then annually on December 10 of each Allocation Year thereafter during the Term. Any Allocable Gate first becoming available for use after March 1 of each Allocation Year shall be reserved for use as a Common Use Gate for the remainder of that Allocation Year (or during any year that the Director has suspended the reallocation of Preferential Use Gates pursuant to Section 3.2), unless, after taking into consideration any recommendation of the RMAC, the Director, in the Director's sole discretion, assigns it to a Signatory Airline as a Preferential Use Gate.

B. The Director's initial determination of the number of Contact Gates in the Domestic Terminals designated for Common Use shall not exceed ten percent (10%) of the total number of Allocable Gates, as rounded to the nearest whole Gate (the "**Common Use Gate Cap**"). Notwithstanding the foregoing, the Common Use Gate Cap shall not apply to the Director's designation of additional Gates for Common Use in accordance with the last sentence of Section 3.3(A), or Gates rejected by any Eligible Signatory Airlines under Section 3.5.

**Section 3.4** Annual Determination of the Number of Preferential Use Gates to be offered to Eligible Signatory Airlines. After determination by City of the total number of Common Use Gates pursuant to Section 3.3, City shall apply the following methodology (as illustrated in Exhibit J) to determine the total number of Preferential Use Gates that will be offered to each Eligible Signatory Airline, including Airline, if applicable, during each Allocation Year, first effective March 1, 2025, and then annually on March 1 of each Allocation Year during the Term:

A. City shall first determine the pool of Eligible Signatory Airlines which are eligible for allocation of a Preferential Use Gate.

B. The City shall divide the number of Scheduled Seats for Airline, including its Affiliate Airline(s), by the total number of Scheduled Seats for all Eligible Signatory Airlines to determine Airline's percentage share of all Scheduled Seats ("**Scheduled Seats Percentage**").

C. The City shall calculate the number of Preferential Use Gates to be offered to Airline by multiplying Airline's Scheduled Seats Percentage by the total number of Allocable Gates, rounding the product to the nearest whole number; provided, however, that a product less than X.5 (with X being a whole number for purposes of this Section 3.4) shall not be eligible for rounding under this Subsection. Based on this rounding, the City shall determine the preliminary number of Preferential Use Gates to be offered to all Eligible Signatory Airlines (the "**Rounded Preferential Use Gate Number**").

D. If the Rounded Preferential Use Gate Number is less than the Allocable Preferential Use Gate Number, City shall allocate such remaining Preferential Use Gates to Eligible Signatory Airlines based on the unrounded results of the computations under Section 3.4(C) (the "**Unrounded Preferential Use Gate Number**"). The remaining Preferential Use Gates shall be allocated in priority order by first increasing by one (1) the number of Preferential Use Gates to be offered to the Eligible Signatory Airline whose unrounded product is nearest to X.5 (with X being a whole number) without equaling or exceeding X.5, and next proceeding to increase by one (1) the number of Preferential Use Gates to be offered to the Eligible Signatory Airline whose unrounded product is second nearest to X.5 without equaling or exceeding X.5 and so on until the total number of Preferential Use Gates to be made available to all Eligible Signatory Airlines by City is reached.

E. If the Rounded Preferential Use Gate Number exceeds the Allocable Preferential Use Gate Number, City shall reduce the number of calculated Preferential Use Gates to be offered to Eligible Signatory Airlines based on the Unrounded Preferential Use Gate Number. The number of over-allocated Preferential Use Gates shall be reduced in priority order by first reducing by one (1) the number of allocated Preferential Use Gates to the Eligible Signatory Airline whose Unrounded Preferential Use Gate Number is nearest to X.5 without being less than X.5 and next proceeding to reduce by one (1) the number of Preferential Use Gates to be offered to the Eligible Signatory Airline whose Unrounded Preferential Use Gate Number is second nearest X.5 without being less than X.5 and so on until the total number of Preferential Use Gates to be made available to all Eligible Signatory Airlines by City is reached.

**Section 3.5** Location of Preferential Use Gates; Notice of Allocation of Preferential Use Gates; Acceptance or Rejection by Airlines.

A. Location of Preferential Use Gates. City shall, in its sole discretion, determine the locations of any Preferential Use Gates to be offered to each Eligible Signatory Airline, including Airline, after taking into consideration: (i) the passenger experience; (ii) the compatibility of such Eligible Signatory Airline's aircraft with the Gate being assigned; (iii) the desirability of assigning contiguous Gates for Preferential Use by any given Eligible Signatory



Airline; (iv) minimizing the frequency of changes in the locations of Preferential Use Gates, and (v) any recommendations by the RMAC.

B. Preliminary Notice of Allocation. Commencing no later than December 10, 2024, and then annually on December 10 of each Allocation Year thereafter during the Term, City shall provide written notice to all Eligible Signatory Airlines, including Airline, offering to Airline its annual allocation of Preferential Use Gates under Section 3.4. Each Eligible Signatory Airline shall provide written notice to City no later than January 15 following such notice either accepting or rejecting any or all of the Gates offered to it by City for Preferential Use (the “**Acceptance Period**”). In the event that Airline shall fail to respond by January 15, then City shall provide one additional written notice of its annual allocation of Preferential Use Gates under this Subsection B (which shall also include an e-mail to Airline’s notice contact set forth in the Summary of Major Terms or otherwise validly noticed to City), and in the event that Airline fails to reply to such additional notice within three (3) days of Airline’s deemed receipt of such notice, Airline will be deemed to have rejected its allocation of Preferential Use Gates under Section 3.5(C) below.

C. Rejection of Preferential Use Gates. If any Signatory Airline does not accept the allocation of a Preferential Use Gate, City may elect to reallocate such Gate to another Signatory Airline if City determines the number of Common Use Gates determined in Section 3.3 is adequate to accommodate all Air Carrier operations needing to use Gates at the Airport. Notwithstanding the foregoing, any Gate rejected for allocation as a Preferential Use Gate by any Eligible Signatory Airline during the reallocation process or at any other time during the Allocation Year (if consented to by City) may be deactivated or used during such Allocation Year as City sees fit, including, without limitation, as a Common Use Gate, notwithstanding the Common Use Gate Cap. Only Gates leased to an Eligible Signatory Airline as a Preferential Use Gate in such Allocation Year and included as part of its Demised Premises for such Allocation Year are included in the determination of Airline Leased Space for the Allocation Year.

D. Final Notice of Preferential Use Gate Assignments. By February 1, 2025 and then annually on February 1 of each Allocation Year thereafter during the Term, City shall provide all Eligible Signatory Airlines, including Airline, if applicable, that validly accepted their allocation of Preferential Use Gates, final notice of the assignments of Preferential Use Gates and the locations of Common Use Gates, to be first effective March 1, 2025 and then annually on March 1 of each Allocation Year thereafter during the Term. Such notice shall be deemed to update Exhibit D hereto without the need for an amendment of this Agreement.

E. Regular Submission of Scheduled Operations Reports. By accepting any Preferential Use Gates hereunder, each Eligible Signatory Airline covenants and agrees to report to City on a regular basis, but in no event less than quarterly, their Scheduled Operations at the Airport for the next ninety (90) days, which such reports may be submitted using SSIM or another electronic format mutually agreeable to the Eligible Signatory Airline and City (“**Scheduled Operation Reports**”). In the event that any Eligible Signatory Airline has not filed any Scheduled Operations Reports as of November 1, 2024, and on November 1 of each year thereafter during the Term (and Airline fails to cure such default within five (5) business days’

notice from City), then the Scheduled Operations for the time periods represented by any Scheduled Operations Reports not submitted shall be deemed to be zero.

#### ARTICLE 4. RENTALS AND FEES

**Section 4.1** Reports and Payments. Airline and City shall deliver the reports and notices regarding Airline Rates and Charges as set forth below, and Airline shall pay to City, without demand or notice other than any invoices provided by City hereunder, and without deductions or set-off, for the use of all premises and facilities, easements, rights, licenses, and privileges granted hereunder, the following rentals, fees and charges during the Term hereof:

A. Notice of Rates and Charges. Not later than sixty (60) days prior to the beginning of each Fiscal Year on July 1, City shall transmit to Airline a notice of the proposed Airline Rates and Charges for said Fiscal Year. Within ten (10) days following the Commission's approval of the final Airline Rates and Charges for the Fiscal Year, City shall transmit to Airline a notice of such final Airline Rates and Charges for the ensuing Fiscal Year.

B. Payment of Rentals. Airline shall render payment of Terminal Area Rentals not later than the first day of each month for which they are due or shall be due, without demand or invoice.

C. Monthly Activity Reports; Payment of Landing and Other Fees.

(i) Airline shall, within fifteen (15) days following the end of each calendar month, transmit to City separate Activity Reports for itself and each of its Affiliate Airlines certifying for said month (1) the data necessary, including actual Revenue Aircraft Arrivals by type of equipment, to calculate the amount of Landing Fees incurred by Airline and its Affiliate Airlines during such month, (2) the number of enplaned and deplaned revenue and non-revenue passengers for Airline and its Affiliate Airlines, (3) the actual enplaned and deplaned cargo weight by cargo type for Airline and its Affiliate Airlines, (4) the data necessary on actual jet bridge usage activity to calculate the amount of jet bridge usage fees incurred by Airline and its Affiliate Airlines, (5) Scheduled Seats for Airline and its Affiliate Airlines, (6) any other information required by the Joint Use Formulas applicable to Airline and its Affiliate Airlines, (7) other required Billing and Operational Information, and (8) data required to calculate the projection of Non-Airline Revenues necessary for determining airline required revenue, the analysis and forecasting of air traffic, and Airport performance metrics.

(ii) In accordance with Sections 4.3 and 5.3, Airline shall calculate such Landing Fees incurred during said month and shall pay such amount on behalf of itself and its Affiliate Airlines within fifteen (15) days after the end of each calendar month, without demand or invoice from City, at the same time it submits the Activity Report. The acceptance by City of any such payment shall not preclude City from questioning the accuracy of Airline's Activity Report submitted to City as provided herein and upon which the Landing Fees are based.

D. Failure to Transmit Activity Report. In the event that Airline fails to transmit to City the Activity Report with data necessary to calculate the amount of Landing Fees incurred by Airline and its Affiliate Airlines during said month, City shall compute and bill Landing Fees based upon data available as though the Revenue Aircraft Arrivals and other data were the same as during the highest month in the immediately preceding Fiscal Year or in the current Fiscal Year, whichever is higher. After receipt of the delinquent Activity Report from Airline, City shall recalculate Landing Fees for the month in question based upon the Activity Report. If the actual Landing Fees are higher than the Landing Fees paid by Airline, the deficiency shall be billed by City to Airline, as applicable. If the actual Landing Fees are less than the Landing Fees paid by Airline, the excess shall be credited by City to Airline. In the event that Airline fails to deliver the Activity Report when due, Airline's proportionate share of fees and charges, where applicable under this Agreement, may be determined at the option of City as though the number of passengers or level of usage were the same as during the highest month during the immediately preceding Fiscal Year or in the current Fiscal Year, whichever is higher.

E. Electronic Reporting, Billing and Payment Systems. City has implemented electronic reporting, billing and/or payment systems to collect Airport activity information, disseminate billing information and process payments as an alternative to the methods described above. In the event that such electronic reporting, billing and/or payment system is at any time not in use or the system is down, City shall use all commercially reasonable efforts to promptly notify Airline, and Airline shall continue to provide manual Activity Reports and payments pursuant to the methods described above until such time as the system is back in operation.

#### **Section 4.2** Rent and Usage Fees.

A. As to all Exclusive Use Space and Preferential Use Space, from and after the Effective Date, Airline shall pay to City on a monthly basis as rental for such space, the product of the number of square feet comprising such space and the rate in effect from time to time for the Space Category comprising such space, as designated in Section 5.2(D). With respect to rent for Preferential Use Gates (i.e., holdrooms), please see Section 4.2(C) below.

B. Airline's Space Categories and square footage designated as "I", "II", "III", "IV" and "V" are assigned relative weighting values as described in Section 5.2(D) and are shown on Exhibit D.

C. The square footage of Preferential Use Gate space shall be based on an average square footage for Preferential Use Gates derived from the total demised square footage of Preferential Use Gates accepted by Signatory Airlines in each boarding area divided by the total number of Preferential Use Gates accepted by Signatory Airlines in each boarding area. Airline's Preferential Use Gate square footage for purposes of rental payments under Section 4.2(A) shall be based on the product of the Preferential Use Gate average square footage for each boarding area and the number of Preferential Use Gates accepted by Airline in each such boarding areas under Article 3. The Preferential Use Gate average square footage for each boarding area and Airline's Preferential Use Gate square footage shall be reviewed and, if required, adjusted annually in accordance with Gate allocations conducted pursuant to Article 3.

D. Airline acknowledges and agrees that the rental rate for all Demised Premises is subject to adjustment from time to time based on changes to the Airline Rates and Charges. For illustrative purposes, the attached **Exhibit K** describes the Terminal Rents applicable to Airline's Exclusive Use Space, Joint Use Space and Preferential Use Space for the Fiscal Year 2022-2023.

E. As to all Joint Use Space, Airline shall pay to City on a monthly basis as rental for such space its proportionate share according to the applicable Joint Use Formula of the category rent applicable to such area.

F. Should Airline be allowed by City to make use of any Gate other than its allocated Preferential Use Gate for Domestic Operations, Airline shall pay to City, when invoiced by City for such use, an appropriate usage fee for all Domestic operations at such Gates, which for the avoidance of doubt, will apply to all Contact Gates, Remote Gates, Domestic Gates and Swing Gates ("**Common Use Gate Domestic Operations Fee**"). The Common Use Gate Domestic Operations Fee shall be calculated as described below and illustrated in **Exhibit F**. The Common Use Gate Domestic Operations Fee for any Air Carrier shall be recalculated as part of the adjustment of Airport Rates and Charges pursuant to this Article 4. City reserves the right to modify the calculation of the Common Use Gate Domestic Operations Fee from time to time following consultation with the Signatory Airlines.

**Section 4.3** Landing Fees. From and after the Effective Date, with respect to each month, Airline shall pay the sum of the Landing Fees applicable to each Revenue Aircraft Arrival of Airline and its Affiliate Airlines that occurred in such month. With respect to each Revenue Aircraft Arrival, the Landing Fees shall equal the higher of (i) the product of the Maximum Landing Weight for a Revenue Aircraft Arrival and the Landing Fee Rate; or (ii) the minimum landing fee for a Revenue Aircraft Arrival established by City from time to time.

**Section 4.4** Payment for Utilities. City reserves the right to continue providing Airline and other Airport tenants with utility services, including electricity, gas, water, sewer, Information and Communications Technology, Shared Use Equipment, rubbish removal and other utilities and services, including, but not limited to, new technology-related services as provided in Section 9.3, and to charge Airline and other Airport tenants legally established rates for such utilities and services.

**Section 4.5** Other Fees. Without limiting any applicable fee, charge or reimbursement provided for elsewhere in this Agreement, City reserves the right to establish, modify and assess from time to time, and Airline agrees to pay, reasonable charges for the Airline's use of additional City-provided facilities, equipment and services including, but not limited to:

A. Use of City-owned loading bridges and related equipment not being charged for through the Common Use Gate Domestic Operations Fee, if applicable.

B. Use of City-owned Baggage Handling Systems and related equipment not being charged for through the Common Use Gate Domestic Operations Fee or the fee for the use of Common Use Check-In Counters, if applicable.

- C. Use of common use break rooms and other facilities provided by City for the use of multiple Airlines or their contracted ground handlers or service providers.
- D. Use of other specialized Terminal Area equipment.
- E. Use of designated aircraft parking sites.
- F. Use of designated employee parking facilities by Airline's employees at rates established from time to time by City.
- G. Terminal Area cleaning and other specialized services requested by Airline or permitted under this Agreement.
- H. Security and personnel identification badges for Airline's personnel.
- I. Office services, such as photocopying or telephone, provided by City. Charges for these services shall be at the rates that City customarily charges for such services.
- J. Telecommunications services.
- K. Use of trash compactor and triturator facilities.

**Section 4.6** **Payment Details.** All payments hereunder shall be paid at the office of Director, or at such other place as Director may from time to time designate in writing. All amounts shall be paid in lawful money of the United States, free from all claims, demands, set-offs, or counterclaims of any kind. Any amounts not paid when due shall be subject to a service charge equal to the lesser of the rate of one- and one-half percent (1.5%) per month and the maximum rate permitted by law. Acceptance of any service charge shall not constitute a waiver of Airline's default on the overdue amount or prevent City from exercising any of the other rights and remedies available to City. Waiver of all or any portion of the applicable service charge on any overdue amount shall not constitute a waiver of Airline's default on the overdue amount or prevent City from exercising any of the other rights and remedies available to City.

**Section 4.7** **Accounting.** Airline shall maintain separate and accurate daily records of Airline's operations hereunder for a period of five (5) years, or, in the event of a claim by City, until such claim of City for payments hereunder shall have been fully ascertained, fixed, and paid. All such books and records shall be kept in accordance with generally accepted accounting principles, consistently applied, showing in detail all business done or transacted in, on, about or from or pertaining to the Airport. Upon Director's written request, Airline shall make available immediately to City and/or its auditors any and all books, records and accounts pertaining to its operations under this Agreement.

## **ARTICLE 5. ADJUSTMENT OF AIRLINE RATES AND CHARGES**

**Section 5.1** **Periodic Review.** The Terminal Area Rentals and Landing Fees set forth in Article 4 shall be re-examined and re-adjusted annually in accordance with the provisions of this Article 5.

**Section 5.2** Method of Adjusting Terminal Area Rentals. Not less than ninety (90) days before the end of the then-current Fiscal Year, Airline shall submit to City in writing any proposed additions to its Demised Premises for the ensuing Fiscal Year. Likewise, not less than ninety (90) days before the end of the then-current Fiscal Year, City shall submit in writing to the Signatory Airlines its budgetary forecast for the Terminal Area Center, GT and Parking Area Center for the ensuing Fiscal Year. From such data and consistent with the Airport Cost Accounting System, City shall calculate the proposed Terminal Area Rentals for each Space Category for the ensuing Fiscal Year and shall forward such proposed Terminal Area Rental calculations to the Signatory Airlines not less than sixty (60) days before the end of the then-current Fiscal Year. City and Airline agree that in calculating Terminal Area Rentals for each Space Category, City shall comply with the following basic methods:

A. Calculation of Annual Basic Rentals:

(i) City shall calculate the estimated total annual Terminal Area costs (the “**Terminal Area Expenses**”) in accordance with the Airport Cost Accounting System illustrated in Exhibit O, including the estimated Annual Service Payment derived in accordance with Section 5.2(B) and the portion of the Annual ORCIF Deposit allocable to the Terminal Area derived in accordance with Section 5.6.

(ii) If City estimates a deficit or surplus in Section 5.5, City shall include the allocable portion of that deficit or surplus as an addition to Terminal Area Expenses for the ensuing Fiscal Year.

(iii) City shall divide the estimated total Terminal Area Expenses, as calculated in Subsections (A)(i) through (A)(ii), by the Gross Terminal Space in the Terminal Area to arrive at City’s estimated Basic Rate per square foot for all Terminal Area Space.

(iv) City shall determine the aggregate Basic Rentals payable by the Signatory Airlines, including Airline, for Exclusive Use Space, Joint Use Space, or Preferential Use Space by multiplying City’s estimated Basic Rate for all Terminal Area Space by the Airline Leased Space.

B. Calculation of Annual Service Payment:

(i) In each Fiscal Year during the Term of this Agreement, City shall include, as an item of expense in the budgetary forecast of Terminal Area Expenses, an amount equal to fifteen percent (15%) of forecasted Concession Revenues to fully compensate City for all indirect services, management and facilities provided by City in the operation of the Airport.

(ii) In the event that fifteen percent (15%) of Concession Revenues does not generate five million dollars (\$5,000,000) in any Fiscal Year, the Signatory Airlines, including Airline, agree that City may include, as an item of expense in the budgetary forecast of Terminal Area Expenses for the ensuing Fiscal Year, an amount

equal to the difference between fifteen percent (15%) of Concession Revenues and five million dollars (\$5,000,000).

C. Calculation of Rental Surcharge (Basic Rental Adjustment):

(i) City shall determine its cost of the Public Space by multiplying the Basic Rate per square foot, arrived at in Subsection (A)(iii) of this Section, by the amount of Public Space in the Terminal Area.

(ii) City shall compute revenues from all sources in the Terminal Area, other than the Basic Rentals to be paid by the Signatory Airlines, including Airline, pursuant to Subsection (A)(iv) of this Section, in accordance with the Airport Cost Accounting System illustrated in **Exhibit O**.

(iii) City shall also calculate any excess of revenues over expenses or any excess of expenses over revenues forecasted to result from its operation of the GT and Parking Area Center, including as an expense the portion of the Annual ORCIF Deposit allocable to the GT and Parking Area Center. Any net expense forecasted from operation of the GT and Parking Area Center shall be included in a surcharge calculation under Subsection (C). Any net revenues forecasted from operation of the GT and Parking Area Center shall be applied to the calculation of the Landing Fees as specified in Subsections of Section 5.3. In calculating net revenues or net expenses in the GT and Parking Area Center, revenues from parking facilities shall be applied to pay the following in the order specified: (1) parking facility expenses; (2) Debt Service allocable to parking facilities; (3) other GT and Parking Area Center expenses; (4) other GT and Parking Area Center Debt Service; and (5) the Annual Service Payment.

(iv) To the extent that the expenses in Subsection (C)(i) exceed the revenues in Subsection (C)(ii), a surcharge (the “**Rental Surcharge**”) will result. The Signatory Airlines, including Airline, shall pay fifty percent (50%) of the Rental Surcharge in the form of a “Terminal Area Rental Surcharge.” The remaining fifty percent (50%) of the Rental Surcharge shall be paid by the Signatory Airlines, including Airline, as a “Landing Fee Surcharge” during the ensuing Fiscal Year.

(v) If the net revenues in Subsection (C)(ii) exceed the expenses in Subsection (C)(i), a “**Basic Rental Adjustment**” will result. The Basic Rental Adjustment will be credited 100% to the Signatory Airlines, including Airline, as a reduction of their Basic Rentals as calculated in Subsections (A)(i) through (iv), above.

D. The sum of the Basic Rentals and the Terminal Area Rental Surcharge (or the Basic Rental Adjustment), hereinafter referred to as “**Terminal Area Rentals**,” paid by all Signatory Airlines for Airline Leased Space, shall be converted to specific “**Terminal Rental Rates**” for the five (5) Space Categories as shown below:

<u>Category</u>	<u>Function</u>	<u>Relative Value</u>
I	Check-In Counters Holdrooms Service Counters and Kiosks	1.00
II	VIP Clubs and Lounges Baggage Claim Lobbies Baggage Service Offices Curbside Check-In Other Enclosed Space Departures Level and above	.75
III	Other Enclosed Space Arrivals Level and below Non-Public Offices and Other Enclosed Areas Arrivals Level and below	.50
IV	Inbound/Outbound Baggage Equipment Rooms	.25
V	Other Unenclosed Space Covered Area – Ramp Level	.10

For any given Fiscal Year, the Terminal Rental Rates for the Airline Leased Space square footage shall be calculated as illustrated in **Exhibit O**.

E. Notwithstanding any other provision hereof, if, at any time during any Fiscal Year, the actual expenses (including Debt Service) in the Terminal Area Center and GT and Parking Area Center are projected by City to exceed by ten percent (10%) or more, for such Fiscal Year, the actual revenues in the Terminal Area Center and GT and Parking Area Center, Commission may increase the Terminal Area Rentals, after using commercially reasonable efforts to reduce expenses and upon sixty (60) days' notice to, and in consultation with, the Signatory Airlines, including Airline. The Signatory Airlines, including Airline, shall pay such additional rentals or such lesser amounts which shall equal such projected deficiency for the remaining months of the then-current Fiscal Year.

**Section 5.3** **Method of Adjusting Landing Fees.** Not less than ninety (90) days before the end of the then-current Fiscal Year, each Signatory Airline (including its Affiliate Airlines) shall submit to City in writing its landed weight forecast for the ensuing Fiscal Year. Not less than ninety (90) days prior to the end of the then-current Fiscal Year, City shall submit in writing to the Signatory Airlines its budgetary forecast for the Access & Roadways Access Area Center, Airfield Area Center, AirTrain Area Center, GT and Parking Area Center, Terminal Area Center, and West of Bayshore Area Center (as provided in Article 6 hereof), together with the portion of the Annual ORCIF Deposit allocable to each such Cost Center derived in accordance with Section 5.6, for the ensuing Fiscal Year. From such data and consistent with the Airport Cost Accounting System, City shall compute the Landing Fee Rate for the ensuing Fiscal Year and shall forward such computations to the Signatory Airlines not less than sixty (60) days before the



end of the then-current Fiscal Year. City and Airline agree that the Landing Fee Rate shall be computed in accordance with the following basic methods:

A. City shall compute the revenues forecast to be received from all sources other than the Signatory Airlines under this Agreement from the Airfield Area, and the total expenses to be incurred in the Airfield Area, including the portion of the Annual ORCIF Deposit allocable to the Airfield Area. The excess, if any, of such expenses over such revenues (“**Airfield Area Net Expense**”) shall be the basic cost element in the determination of Basic Landing Fees to be paid by the Signatory Airlines, including Airline, in the ensuing Fiscal Year.

B. City shall compute the projected revenues to be received and expenses to be incurred in the West of Bayshore Area Center in the ensuing Fiscal Year, including the portion of the Annual ORCIF Deposit allocable to the West of Bayshore Area. The excess of such expenses over such revenues or any excess of such revenues over such expenses shall be included in the computations as an addition to or reduction of Airfield Area Net Expense.

C. If City estimates a deficit or surplus in Section 5.5, City shall include the allocable portion of deficit or surplus as an addition to Airfield Area Net Expense for the ensuing Fiscal Year.

D. After calculating Airfield Area Net Expense pursuant to the foregoing Subsections of this Section, City shall divide the resulting forecast of Airfield Area Net Expense by the composite landed weight forecast to arrive at the Basic Rate for the ensuing Fiscal Year.

E. Any net revenue forecasted from operation of the GT and Parking Area Center pursuant to Section 5.2(C)(iii) shall be applied to the Landing Fee Surcharge in Subsection (F).

F. If a Rental Surcharge is calculated in Section 5.2(C)(iii), then fifty percent (50%) of such Rental Surcharge shall be collected as a Landing Fee Surcharge during the ensuing Fiscal Year.

G. City shall divide the resulting forecast of Landing Fee Surcharge by the composite landed weight forecast provided by City based on information obtained from the Signatory Airlines, including Airline, to arrive at the Surcharge Rate for the ensuing Fiscal Year.

H. The sum of the Basic Rate and the Surcharge Rate shall equal the Landing Fee Rate for the ensuing Fiscal Year.

I. The sum of the Basic Landing Fees and the Landing Fee Surcharge shall equal the Landing Fees for the ensuing Fiscal Year.

J. Notwithstanding any other provision hereof, if at any time during any Fiscal Year, the actual expenses (including Debt Service) in the Airfield Area Center and Other Leased Areas Center are projected by City to exceed by ten percent (10%) or more, for such Fiscal Year, the actual revenues in the Airfield Area and Other Leased Areas Center, Commission may increase the Landing Fees, after using commercially reasonable efforts to

reduce expenses and upon sixty (60) days' notice to, and in consultation with the Signatory Airlines, including Airline. The Signatory Airlines, including Airline, shall pay such additional Landing Fees or such lesser amounts that shall equal such projected deficiency for the remaining months of the then-current Fiscal Year.

K. City shall charge non-Signatory Airlines (excluding Affiliate Airlines which shall pay the Landing Fees available to Signatory Airlines) a twenty-five percent (25%) premium on Landing Fees.

**Section 5.4** Review of Adjusted Rentals and Fees.

A. Unless otherwise requested by a Majority-in-Interest, Director shall call a meeting with the Signatory Airlines to be held not less than fifteen (15) nor more than thirty (30) days after forwarding, pursuant to Sections 5.2 and 5.3, the Terminal Area Rentals and Landing Fee Rate proposed for the ensuing Fiscal Year for the purpose of reviewing such rentals and fees with the Signatory Airlines. City understands and agrees that, in advance of the said meetings, it shall make available to the Signatory Airlines any additional information reasonably requested by them regarding the budgetary forecasts forwarded pursuant to Sections 5.2 and 5.3. The City shall give due regard to any comments offered by the Signatory Airlines on the proposed calculations of the Terminal Area Rentals and Landing Fee Rate for the ensuing Fiscal Year. Within thirty (30) days after the meeting, or the forwarding of the rentals and fees to the Signatory Airlines if no meeting shall be held, the rentals and fees, as calculated by City in accordance with this Agreement and the Master Bond Documents, shall become effective.

B. Airline and City agree that the time periods for notices, meetings, exchanges of information and for the establishment of the Terminal Area Rental Rates and the Landing Fee Rate as provided for in this Article 5 may be altered by the Commission if deemed by the Commission to be necessary to meet the time requirements of City's annual budgetary process; provided, that the number of days allocated for Signatory Airline review of data submitted by City shall not, without good cause, be reduced; and, provided further, that the Commission and the City shall use commercially reasonable efforts to establish Terminal Area Rental Rates and Landing Fee Rate for any Fiscal Year within one hundred twenty (120) days following the commencement of the Fiscal Year for which rates are being developed, and, when so finally determined, such rentals and fees shall be made retroactive to the first day of such Fiscal Year.

**Section 5.5** Reconciliation of Airline Rates and Charges and Application of Prior Period Deficits (Surpluses).

A. As part of City's preparation of its annual audited financial statements, City shall calculate any deficit or surplus in Airline Rates and Charges using actual expenses (including the amount, if any, required to meet the Rate Covenant in the Master Bond Documents for such Fiscal Year) and Non-Airline Revenues to determine any deficit or surplus in the amount of Airline Rates and Charges. Any such deficit or surplus would be recorded as part of that Fiscal Year's financial data and would result in an adjustment to the amount carried on the balance sheet as Unearned Aviation Revenue (or Aviation Revenue Due) ("**Deferred Aviation Revenue**" liability (or receivable, if appropriate).

B. The Deferred Aviation Revenue liability (or receivable, if appropriate) balance shown at the end of the preceding Fiscal Year, together with any deficit or surplus estimated in the budgetary forecast for Airline Rates and Charges during the then-current Fiscal Year, would constitute the amount of deficit or surplus available to be applied in the ensuing Fiscal Year.

C. If the determination referenced in Subsection (B) above results in an estimated deficit for the then-current Fiscal Year and this deficit exceeds or will exceed the total budgetary forecast by five percent (5%), then the Signatory Airlines must be advised in writing at the time that City becomes aware of the aforementioned deficit.

D. The amount of deficit or surplus determined by City to be applied to the calculation of the ensuing Fiscal Year's Airline Rates and Charges will be allocated between adjusted Terminal Area Center Expense and Airfield Area Center Net Expense in proportion, respectively, to Terminal Area Rentals and Landing Fees to total Airline Rates and Charges.

E. With respect to any Signatory Airline who does not become a signatory to a future lease and use agreement with City after the Expiration Date of this Agreement (a "**Successor Lease and Use Agreement**"), within 30 days after City's preparation of its final annual audited financial statements for the Fiscal Year ending June 30 of the year of termination of this Agreement, City or Signatory Airline, as appropriate, shall remit to the other the Signatory Airline's allocable share of any Deferred Aviation Revenue liability (or receivable, if applicable) balance shown at the end of such Fiscal Year. City's calculation of the allocable share to such Signatory Airline shall be binding absent manifest error. The parties expressly agree that obligations of this provision shall survive the Expiration Date.

**Section 5.6** Operating Revenue and Capital Improvement Fund.

A. City shall have the right to create and maintain an Operating Revenue and Capital Improvement Fund (**ORCIF**) within the Airport Revenue Fund held and invested by the City Treasurer. Funds on deposit in the ORCIF may be used for any lawful purpose for which Airport Revenues may be used and may not be used for any purpose that could not be funded with Airport Revenues. Expenditures on Capital Improvements from the ORCIF shall be subject to Section 6.2 [Review of Capital Improvements] but, for the avoidance of doubt, shall not be subject to Section 6.1(B), nor shall expenditures from the ORCIF count toward the limit set forth in Section 6.1(B).

B. As part of City's preparation of its estimated expenses for each Cost Center for the ensuing Fiscal Year, City shall determine the amount, if any, to be deposited to the ORCIF in such Fiscal Year (the "**Annual ORCIF Deposit**"). The Annual ORCIF Deposit shall be greater than or equal to the Minimum Annual ORCIF Deposit and shall not exceed the Maximum Annual ORCIF Deposit; provided, however, that no deposit shall be made to the ORCIF in any Fiscal Year when the unencumbered and unallocated balance of the ORCIF at the start of the Fiscal Year exceeds Six Hundred Fifty Million Dollars (\$650,000,000), as adjusted by the applicable Index commencing with Fiscal Year 2024-2025, provided that any interest earned on the amounts on deposit shall not be counted for purposes of the foregoing limitation. The City shall also determine the amount of the Annual ORCIF Deposit to be allocated to each

Cost Center, which shall reflect such Cost Center's proportionate share of the estimated total expenses for the Airport for such Fiscal Year. An example of such calculation is set forth in **Exhibit R** ("Example of Calculation of Annual ORCIF Deposit and Allocation to Cost Centers").

C. The amounts necessary to aggregate to the Annual ORCIF Deposit shall be included in the calculation of Airline Rates and Charges as further set forth in Article 5, subject to the proviso set forth in the definition of Additional Annual ORCIF Deposit.

## ARTICLE 6. CAPITAL IMPROVEMENTS

### **Section 6.1** Financing of Capital Improvements.

A. Except as provided in Section 6.1(B) and (C) below, City agrees to use commercially reasonable efforts to finance Capital Improvements through the use of grants, TSA funding and PFCs, and through the issuance of Airport Revenue Bonds. City may, in its discretion, finance through the issuance of Airport Revenue Bonds: (i) Capital Improvements with a useful life of less than three (3) years but more than one (1) year or a cost of less than the Charge Trigger Amount, and (ii) maintenance or operating expenses or other expenses.

B. During the Term of this Agreement, except as set forth in the last sentence of this subsection with respect to the ORCIF and Section 6.1(C) with respect to CFC Revenue, no Capital Improvement provided for in this Section or Section 6.2 shall be financed from current Revenues; provided, however, the Commission may appropriate from current Revenues up to five million two hundred thousand dollars (\$5,218,606) in Fiscal Year 2021/2022 dollars, as adjusted by the Index, in any Fiscal Year, for use pursuant to Sections 16.104(b)(5) and (6) of the City Charter (or any successor legislation) or such additional amounts as may be approved by a Majority-in-Interest. For the avoidance of doubt, City may fund Capital Improvements from amounts on deposit in the ORCIF without violating this Section 6.2(B).

C. Notwithstanding the foregoing, the limitations on Capital Improvements set forth in Sections 6.1(A) and (B) shall not apply to Capital Improvements to the extent funded with revenue derived from Customer Facility Charges ("CFC Revenue"), which are not considered current Revenue for purposes of this Agreement. Furthermore, for the avoidance of doubt, to the extent any such Capital Improvements are funded solely with CFC Revenue, the provisions of Section 6.2 below shall not apply.

### **Section 6.2** Review of Capital Improvements.

A. Any Capital Improvement, which would result in a charge to Airline in the Terminal Area Rentals or Landing Fees, having a cost in excess of the Charge Trigger Amount, excluding any capital improvements made in the development of the West of Bayshore Area, are subject to the provisions of Subsections B and C of this Section unless:

(i) The Capital Improvement is required by a federal or State agency having jurisdiction over Airport operations (including, without limitation, the FAA), or necessary to comply with any current or future law, rule, regulations, order of judgment

of any Federal, state or local agency (excluding the Commission) or court, or any Federal grant agreement or airport certification requirement, including any required modification or replacement of any air traffic control facilities;

(ii) The Capital Improvement is to improve the safe operations of the Airport;

(iii) The Capital Improvement is to protect essential infrastructure from storm events or relocate such infrastructure;

(iv) The Capital Improvement is an Airfield Area project eligible for Federal funding for which City has received the full level of eligible Federal funding;

(v) The Capital Improvement is financed by the issuance of Special Facility Bonds; or

(vi) The Capital Improvement is of an emergency nature, which, if not made, would result in the closing of the Airport within forty-eight (48) hours or otherwise substantially impair the current operation of the Airport;

(vii) The Capital Improvement is to repair or replace Airport property damaged or destroyed by fire or other casualty, or taken by condemnation, or otherwise for the restoration or replacement of Airport capacity; or

(viii) The Capital Improvement is made to settle claims or lawsuits, satisfy judgments or comply with judicial or administrative orders against City arising from or relating to its design, construction, ownership, maintenance or use of the Airport; or

(ix) As provided by 49 U.S.C. § 40117(f), any portion of a Capital Improvement financed by PFCs or PFC-backed bonds; provided, however, that any portion of a Capital Improvement that would result in a charge to Airline in the Terminal Area Rentals or Landing Fees may be subject to Majority-in-Interest voting or approval of such costs under Subsections (B) and (C) below, unless such costs have already been approved or are exempt from such voting or approval; or

(x) The Capital Improvement is required to procure and install electrical infrastructure necessary to reach City's and Airline's mutual goal of converting all ground service equipment operating at the Airport to be powered by 100% electricity, as further set forth in Section 23.3; or

(xi) The Capital Improvement is undertaken to satisfy the increased requirements of any Air Carrier so long as such Air Carrier agrees to pay all increased rentals, fees and charges that are sufficient to cover the annual Debt Service and operating expenses associated with the project; or

(xii) The Capital Improvement is related to special purpose facilities for which the user agrees to pay or reimburse City.

The cost of each Capital Improvement shall include the cost of planning and design, if any.

B. Unless the Capital Improvement meets one of the criteria set forth in Subsections (A)(i)-(xii) of this Section, the Signatory Airlines shall be notified in writing of the proposed Capital Improvement and the decision of a Majority-in-Interest whether or not to object to the Capital Improvement shall be forwarded to City within forty-five (45) days of the Airport providing full information to Signatory Airlines on the proposed project in substantially the form set forth in **Exhibit Q** (as such form may be revised by City from time to time). The Director, at the Director's sole discretion, may extend the forty-five (45) day period for the Majority-In-Interest to file objection. Airline covenants that, in the exercise of its discretion regarding objections to Capital Improvements, it will base its decision upon prudent judgment and sound airport management policies.

C. City shall not proceed with any Capital Improvement that has been objected to by a Majority-in-Interest for a period or periods specified by the Signatory Airlines not to exceed six (6) months in the aggregate from the date of the Signatory Airlines' notice of objection to said Capital Improvement proposal. During such time, the Signatory Airlines may develop and present their opposition to said Capital Improvement to the Commission at a public hearing, or otherwise. At the end of such six (6) months period, City may proceed with the Capital Improvements notwithstanding objection by a Majority-in-Interest.

D. City may pledge Revenues as further security for Special Facility Bonds, or issue Airport Revenue Bonds to refund Special Facility Bonds, if (i) the Signatory Airlines are notified in writing of the proposed pledge or issuance, and (ii) such pledge or issuance is not objected to by a Majority-in-Interest within forty-five (45) days of the mailing to Signatory Airlines of the notification.

**Section 6.3** Development of West of Bayshore Area.

A. The Signatory Airlines shall have no responsibility for and shall not bear, directly or indirectly, any costs involved in developing the West of Bayshore Area, such costs to include expenses associated with any architectural, engineering, and other consultant studies, and evaluations or reports related to potential development projects. The Signatory Airlines recognize, however, that the maintenance costs of the property in its current undeveloped state will be attributed to the Airport and that such costs are included in calculations to determine Landing Fee Rates. It is understood and agreed that maintenance costs for the whole or portions of the West of Bayshore Area shall continue to be attributed to the Airport only until the commencement of any development (as evidenced by physical work performed in the West of Bayshore Area) of the West of Bayshore Area or such portion(s) thereof or its lease, sale, or other transfer to any other department of City or any other entity.

B. In the event of any development of the West of Bayshore Area or portions thereof or its lease, sale or other transfer, said West of Bayshore Area or portions thereof shall be

developed, operated and maintained solely with non-Airport revenues, and without Airport revenues being pledged directly or serving indirectly as security for debt incurred for such purposes. Except as otherwise provided in this paragraph, the Signatory Airlines will have no claim to any revenues generated by the West of Bayshore Area as a result of its development, nor any control or claim as to the manner in which City uses, transfers, diverts or disposes of such revenues, nor any right to approve or challenge the development, transfer, sale, leasing or other disposition of the West of Bayshore Area or any part thereof. Claims to the benefits of development in the West of Bayshore Area or requirements of approval or support by any persons or authorities other than the Signatory Airlines are the sole responsibility and risk of City.

C. The Commission, the Board and the City agree that any development of the West of Bayshore Area, if any, shall be in a manner consistent with maintaining the integrity of the Cost Centers and Airport revenues attributable thereto, as provided in this Agreement. The Commission and the City agree not to relocate present Airport businesses or concession operators to the West of Bayshore Area or induce prospective businesses or concession operators to locate within the West of Bayshore Area rather than the Airport to the detriment of Airport revenues or the Signatory Airlines and further agree that any lease, sale or other transfer of the property will contain these covenants.

D. Notwithstanding the foregoing, it is agreed that City may develop a hotel, office complex, shopping center, or warehousing in the West of Bayshore Area and may locate any other business facility or concession in the West of Bayshore Area that City has made a good faith effort to locate or accommodate on the Airport and which cannot be physically so located or accommodated. Parking facilities, if any, shall not be made available to the public at rates below those in effect, from time to time, at Airport remote parking lots.

## **ARTICLE 7. RECAPTURE OF EXCLUSIVE USE SPACE; RELOCATION OF PREMISES; CITY ACCOMMODATION RIGHTS**

**Section 7.1** Recapture of Exclusive Use Space Following Any Reduction in Number of Preferential Use Gates. If the number of Preferential Use Gates assigned to Airline is reduced during the Term of this Agreement for any reason (other than a rejection of Preferential Use Gates by Airline, which shall be handled pursuant to Section 7.2 below), City may at any time thereafter and from time to time, after taking into account any recommendations of the RMAC, but at City's sole discretion and upon sixty (60) days written notice to Airline, terminate Airline's rights to use all or a portion of Airline's Exclusive Use Space, including, but not limited to, check-in counters and Support Facilities, that is reasonably required to support the operations of other Air Carriers using the Preferential Use Gates no longer assigned to Airline; provided, however, that City shall not so terminate rights to Exclusive Use Space that, in the Director's reasonable discretion, are required to support Airline's operations at Airline's remaining Preferential Use Gate(s), if any. In case of recapture hereunder, City shall issue to Airline a Space Change Summary Notice documenting the recapture of any portion of Airline's Exclusive Use Space under this Section. Airline's surrender of Exclusive Use Space pursuant to this Section or surrender of Preferential Use Gates shall be subject to the terms of Article 18 of this Agreement [Surrender of Possession of Demised Premises].

**Section 7.2** Recapture of Exclusive Use Space Following Rejection of Preferential Use Gates by Airline. Whenever Airline declines to accept a Preferential Use Gate following allocation of Gates pursuant to Section 3.5, City may at any time thereafter and from time to time, after taking into account any recommendations of the RMAC, at City's sole discretion and upon sixty (60) days written notice to Airline, reclaim all or a portion of Airline's Exclusive Use Space associated with the rejected Preferential Use Gate, including, but not limited to, check-in counters and Support Facilities, in accordance with the following procedure:

A. If there is another Signatory Airline that is willing to lease the reclaimed space, Airline and the other Signatory Airline shall attempt to negotiate an agreement as to any changes to the condition or layout of the space, any required sharing of Support Facilities such as hallways and baggage areas, any associated costs, and any other provisions required to permit the other Signatory Airline to use the reclaimed space for its intended purpose.

B. If Airline and the other Signatory Airline cannot reach agreement on the items listed above, City shall join the negotiations and attempt to mediate an agreement.

C. If City is unable to mediate an agreement on the items listed above, the Director shall develop a reasonable solution and notify both Airline and the other Signatory Airline of the decision.

D. Any changes to Airline's Demised Premises and the other Signatory Airline's leased space as a result of Subsections (A) through (C) above shall be documented by City issuing a Space Change Summary Notice to Airline and the other Signatory Airline.

E. Airline shall be responsible for the cost of removing its furniture, fixtures, and equipment from the reclaimed space and returning the reclaimed space to a tenantable condition in accordance with the provisions of Article 18 of this Agreement [Surrender of Possession of Demised Premises], and such reclaimed space shall revert to the possession and control of City.

F. Under no circumstances shall Airline be responsible for any costs greater than those required to vacate its furniture, fixtures, and equipment, including communications and utility lines, from the reclaimed space and to return the reclaimed space in the condition provided in Section 7.2(E) above.

**Section 7.3** Relocation of Airline Demised Premises and Operations.

A. Involuntary Airline Relocation. From time to time during the Term of this Agreement, part or all of the Demised Premises and Airline's operations may be required by City to be relocated for any one or more of the following reasons: (1) for implementation of improvements at the Airport; (2) for accommodation of the traveling public; (3) in order to maximize the use and/or operations of the Terminals and related facilities by Air Carriers (including Airline) and other tenants, lessees, permittees, and users thereof; or (4) to accommodate the Voluntary Airline Relocation of another Air Carrier to which City has consented to, or the Involuntary Airline Relocation of another Air Carrier (each an "**Involuntary Airline Relocation**"). Airline agrees to comply with any such Involuntary Airline Relocation in



accordance with the terms of this Section 7.3. In any such Involuntary Relocation, the actual, reasonable requirements of Airline for Terminal space to accommodate its operations at the Airport shall be given consideration. In connection with any Involuntary Airline Relocation:

(i) City shall provide at least sixty (60) days advance written notice of the Director's decision to implement an Involuntary Airline Relocation and the reallocation of space in the Terminals, provided Director and Airline may agree to reasonable extensions of time necessary to accommodate said relocation.

(ii) Airport shall reimburse to Airline the following costs upon the final completion of such Involuntary Airline Relocation ("**Involuntary Airline Relocation Costs**"): (a) reasonable costs of relocating Airline's furniture, movable fixtures equipment and signage in connection with the Involuntary Airline Relocation; and (b) the reasonable costs of Airline's third party construction costs relating to tenant improvements in the relocated premises that are of substantially similar level of fit and finish as to the demised premises being vacated when finally constructed and completed, subject to the Director's consent pursuant to Section 10.6 of this Agreement;

(iii) The following costs shall not be considered Involuntary Airline Relocation Costs reimbursable to Airline: (a) the value of any unamortized improvements at the Demised Premises occupied by Airline prior to the Involuntary Airline Relocation; (b) costs of replacement of any trade fixtures or movable property of Airline if removal of the same from the existing premises and reinstallation at Airline's new premises is possible and not unreasonable; or (c) costs resulting from relocation of or within (1) Joint Use Space or (2) Preferential Use Space resulting from annual reallocation, acceptance or rejection of Gates in accordance with Article 3; and

(iv) All Involuntary Airline Relocation Costs shall be subject to rate recovery under Articles 4 and 5 and **Exhibit O**.

B. Voluntary Airline Relocation. In the event Airline shall at any time during the Term request that part or all of its Demised Premises and operations be relocated to other areas of the Airport (an "**Voluntary Airline Relocation**"), such relocation shall be subject to the Consent of the Director. In submitting a request for consent for an Airline Voluntary Relocation, Airline shall submit a full plan for such relocation, including any other resultant required relocations or other impacts to any other Air Carriers, tenants, lessees, permittees and other Airport users.

C. Responsibility for Relocation Costs. Any and all costs relating to the Voluntary Airline Relocation, as well as all other relocations, temporary moves and other direct impacts to other Air Carriers, tenants, permittees, other Airport users and City required or otherwise made necessary as a result of the Voluntary Airline Relocation, shall be the sole responsibility of the Airline party responsible for the initial Voluntary Airline Relocation.

D. Merger/Acquisition of Airline. Notwithstanding anything in this Agreement to the contrary, in the event of any acquisition or merger involving Airline, any resulting relocations of Airline's Demised Premises and operations (including any required

resultant relocations, temporary moves and other impacts to other Air Carriers, tenants, permittees and other Airport users required in connection therewith), shall be deemed to be a Voluntary Airline Relocation, regardless if the relocation is required by City, if the City deems such relocation necessary from an operational and/or customer service perspective, in its sole and absolute discretion, and all costs shall be for the collective account of Airline and any such entity surviving the acquisition or merger, on a joint and several basis.

E. Relocations as Part of Annual Reallocation or Acceptance or Rejection of Gates. Notwithstanding anything in this Agreement to the contrary, Airline shall not be entitled to reimbursement for relocation of or within (a) Joint Use Space, or (b) Preferential Use Space resulting from the annual reallocation of Allocable Gates, or Airline's acceptance or rejection of Gates in accordance with Article 3.

F. Surrender. Whether due to an Involuntary Airline Relocation or Voluntary Airline Relocation, in surrendering any portion of a Demised Premises under this Section 7.3, Airline will comply with the requirements of Article 18 [Surrender of Possession of Demised Premises].

**Section 7.4** Accommodation of Other Air Carriers in Airline's Exclusive Use Space.

A. To facilitate the entry of new Air Carriers and to maximize the utilization of facilities at the Airport, City shall have the right to accommodate other Air Carriers in Airline's Exclusive Use Space, on the terms and conditions set forth in this Section 7.4.

B. City shall first attempt to accommodate Air Carriers which have space needs with space needs using available and uncommitted space in the applicable Terminal, access to Common Use Support Facilities or Joint Use Space. If any such space cannot adequately accommodate the requesting Air Carrier needs, City shall have the right to require accommodation of a requesting Air Carrier in Airline's Exclusive Use Space as follows: Airline agrees, upon request by City, to make all reasonable efforts to facilitate the temporary accommodation of an Air Carrier's operations, including use of space for a ticket counter area, use of Airline's baggage facilities and the rendering of customary ground services, if (1) Airline has adequate capabilities, capacity, facilities and personnel therefor, after taking into account Airline's own requirements and contractual obligations, and the compatibility of said Air Carrier's proposed operations with those of Airline, and (2) said Air Carrier enters into a written agreement with Airline therefore and agrees to (a) pay Airline established rental rates for space and the established rates and charges for services provided to said Air Carrier, (b) indemnify and hold harmless Airline and Airline Entities to the same extent as Airline is required to indemnify the City hereunder for claims or liability (including fines and penalties arising out of or in connection with such Air Carrier's acts or omissions or use of the Demised Premises), and (c) carry insurance in the amounts and of the type(s) as may be reasonably requested by Airline, not to exceed the insurance required of Airline under this Agreement. Any accommodation of an Air Carrier under the procedures hereof may be pursuant to a sublease, handling agreement, or a combination thereof, mutually agreed upon by the parties and subject to the Director's prior written approval.

C. Nothing contained in this Agreement, nor the rights conferred herein, shall prevent or prohibit the entering into of inter-airline agreements between Airline and other Air Carriers authorized to operate into and out of the Airport; provided, however, that any agreements between Airline and another Air Carrier providing for the shared use of any of the facilities in the Exclusive Use Space leased to Airline shall be subject to Director's prior written consent.

D. During any use of Airline's facilities by another Air Carrier at City's request pursuant to this Section, Airline shall thereupon be relieved of any obligation under this Agreement to indemnify and save harmless City and City Entities with regard to any claim for damages or personal injury arising out of or in connection with said accommodated Air Carrier's use of the Demised Premises unless proximately caused by the sole negligence of Airline or any Airline Entity that has come upon the Demised Premises in connection with Airline's occupancy hereunder. The City shall, however, require such indemnification from such other Air Carrier.

**Section 7.5** Accommodation of Other Air Carriers at Airline's Preferential Use Gates.

A. To facilitate the entry of new Air Carriers and to maximize the utilization of facilities at the Airport, City shall have the right to accommodate other Air Carriers at Airline's Preferential Use Gates, on the terms and conditions set forth in this Section 7.5

B. City shall have the right, upon reasonable notice to Airline, to schedule arrivals and departures by a Requesting Airline at a Preferential Use Gate at all periods of time other than Airline's established Periods of Use of that assigned Preferential Use Gate. In accommodating City in its right to schedule such operations at a Preferential Use Gate, Airline shall allow and provide for use of its facilities, fixtures and equipment (not including mobile ground service equipment) at the Preferential Use Gate as may be required for the efficient use of the Preferential Use Gate by City or a Requesting Airline. Notwithstanding the foregoing and any other provision of this Article 7, in addition, City shall have the right, upon reasonable notice to Airline, to accommodate arrivals and departures by a Requesting Airline at a Preferential Use Gate during Airline's Periods of Use of that Preferential Use Gate if Airline is not using the Preferential Use Gate during the Period of Use for a Scheduled Operation. City shall have the sole right to determine whether a Period of Use is available, using all data sources available to City, including but not limited to the Quarterly Scheduled Operation Reports provided to City pursuant to Section 3.5(E).

C. If an arrival or departure of Airline that would have used one of Airline's Preferential Use Gates is early or late and Airline is prevented from using any of its Preferential Use Gates because they are already being used by Requesting Airlines, City shall, whenever possible, accommodate Airline's arrival or departure on a Common Use Gate at no additional charge to Airline for its use of the Common Use Gate, and Airline shall continue to be entitled to the credit referenced in Section 7.6 below.

D. Prior to accommodating a Requesting Airline at a Preferential Use Gate, City shall first, whenever it is practical to do so, consider the availability of Common Use Gates and any recommendations by the RMAC. Second, City shall consider the utilization rate of Preferential Use Gates by Airline using all available data sources, including, without limitation,

the Quarterly Scheduled Operation Reports provided to City pursuant to Section 3.5(E), and will make reasonable efforts to accommodate the Requesting Airline at the Preferential Use Gates of the Airline with the lowest Preferential Use Gate utilization rate, as measured by the number of Scheduled Seats per Preferential Use Gate per day, provided, however, that such utilization rate shall not be the sole determining factor, and City shall have the right to take into consideration any undue burden to the passengers of the Requesting Airline in determining the location of the accommodation, as reasonably determined by City. In the event that Airline has not provided the Quarterly Scheduled Operations Reports at the time a request for an accommodation at a Preferential Use Gate has been made, City may assume that Airline is not using its Preferential Use Gates for any Scheduled Operations solely for purposes of this Section 7.5, provided, further, that City expressly reserves all rights and remedies resulting from such failure to provide such reports.

E. Airline shall have no scheduling preference during a Period of Use at its Preferential Use Gates under this Article 7 for any operation other than a Scheduled Operation. If Airline fails to vacate its Preferential Use Gate in a timely manner to allow for the operation of a Requesting Airline during Requesting Airline's Period of Use at such gate, Airline will be subject to the same fees and/or charges as would be due in the event Airline failed to vacate a Common Use Gate after its own scheduled Period of Use.

F. Requesting Airline must follow all Gate Management Protocols that would be otherwise required of Requesting Airline on a Common Use Gate, including, without limitation, maintaining an average utilization rate for its Period of Use on the accommodated Preferential Use Gate of 80%, measured on a rolling 28-day basis, as determined by City in its sole and absolute discretion.

G. Unless earlier terminated by City for any reason, assigned by City to a Common Use Gate, or released by the Requesting Airline, the accommodation of a Requesting Airline at a Preferential Use Gate under this Article 7 shall remain in effect until the annual reallocation of Preferential Use Gates pursuant to Article 3.

H. On no less that a quarterly basis, City shall conduct a review of all accommodations of Requesting Airlines on Preferential Use Gates to determine the availability of Common Use Gates for the operations of the Requesting Airline, which such determination shall be made in the sole and absolute discretion of City.

**Section 7.6** Charges for Use of Preferential Use Gate by Another Air Carrier. Any Requesting Airline that is accommodated at any of Airline's Preferential Use Gates shall be required to pay City the same charges for use of the Preferential Use Gate that it would have been required to pay for use of a Common Use Gate. The City shall provide a credit to Airline for one-half of the amount of any such Gate-use payment.

**Section 7.7** Charges for Use of Exclusive Use Facilities by Another Air Carrier. Any Requesting Airline that is accommodated at any of Airline's Exclusive Use check-in or baggage claim facilities shall be required to pay City the same charges for use of those facilities that it would have been required to pay for use of a Common Use facility. The City shall provide a

credit to Airline for one-half of the amount of any such common use baggage claim or check-in counter fee.

**Section 7.8** Gate Accommodation Conditions. As a condition of accommodation on any of Airline's Preferential Use Gates, the Requesting Airline shall have executed an agreement with City that is substantially in the form of the Lease and Use Agreement or an Operating Permit, as applicable, through which the Requesting Airline is bound by insurance and indemnification obligations that are substantially similar to the obligations set forth herein. These insurance and indemnification obligations shall inure to the benefit of the Airline as a third-party beneficiary for any period of accommodation, and Airline shall not be required to accommodate a Requesting Airline at its Preferential Use Gates if the Requesting Airline's insurance and indemnification obligations are not satisfied.

## ARTICLE 8. MISCELLANEOUS COVENANTS OF CITY

**Section 8.1** Prudent Operation. City covenants that it will efficiently manage and operate the Airport on the basis of sound business and airport management principles in effect at airports of comparable size in the continental United States and with efficient and prudent control of all capital and operating expenses.

**Section 8.2** Revenues From Non-Airline Sources. Consistent with the provisions of Section 8.1, City agrees that it will use commercially reasonable efforts to operate the Airport in a manner consistent with its strategic marketing and public relations plans in order to maximize revenues from concessionaires, lessees and other non-airline users; provided, however, that City will not permit the installation of concession facilities in such a manner or at such locations in the Terminal Area as will materially obstruct traffic or impede Airline's ability to perform the functions enumerated in Section 2.2.

**Section 8.3** Airfield Area Users. City agrees that it shall require all users of the Airfield Area to pay for their use thereof. The portion of Airfield Area expenses payable through fees to be charged to other than Signatory Airlines and their Affiliate Airlines may be based on some collection method other than a per-thousand-pounds landing fee rate, but whatever the method of payment, whether it be by aviation fuel through-put charges paid to City or by minimum flat-rate landing fees or other means, the amounts so paid to City shall be credited to the Airfield Area or to the Other Leased Areas, as appropriate, so as to reduce the amount of Airfield Area Net Expense to be collected from the Signatory Airlines and their Affiliate Airlines through Landing Fees. City agrees that it will adjust such fees charged to users of the Airfield Area other than the Signatory Airlines and their Affiliate Airlines from time to time to reflect its changing costs due to inflation, improvements, betterments or increased demands placed upon the Airfield Area facilities.

## ARTICLE 9. PIPELINES AND UTILITIES

**Section 9.1** Reservations by City. City reserves the right, with reasonable advance notice to Airline, to construct, reconstruct, install, repair, remove, renew, operate and use pipelines, utility lines, roadways, or structures for Airport purposes across, over, or under any of

Airline's rights of way or Demised Premises, but Airline's enjoyment of its rights of way or Demised Premises shall not be unnecessarily interfered with.

**Section 9.2** Relocation of Pipelines. In the event that any pipeline, utility line or appurtenance installed by Airline be so located that it shall be necessary to change, alter, relocate or reconstruct same in order to allow City to install sewer or drain lines, such change, alteration, relocation or reconstruction of said pipeline shall be made as requested by City. The cost of such change, alteration, relocation or reconstruction of said pipelines shall be subject to rate recovery under Article 5.

**Section 9.3** Information and Communications Technology; Utilities. City has provided or shall provide in or in the vicinity of the Demised Premises the following utility services: water, electricity, Information and Communications Technology, Shared Use Equipment, sewage outlets, heating, ventilation, and air conditioning of the Demised Premises as indicated in the plans and specification thereof. Airline shall ascertain from City, and City shall make available, the information as to the points at or near the Demised Premises where such services will be brought by City at the cost and expense of the Commission as an Airport expense. All extensions of the facilities requested by Airline for said utility services from said points shall be at the sole cost and expense of Airline unless other arrangements are made therefor. In the event of any change desired by Airline as to said points of supply by City, the expense of making such changes shall be at the sole cost of Airline. Except as otherwise provided herein, and consistent with Section 4.4 of this Agreement, Airline shall pay the whole cost at legally established rates for all utility services and for such other special services which it may require in the Demised Premises. Airline shall not be charged for the supply of heating, ventilation, and air conditioning of the Demised Premises.

## **ARTICLE 10. DEVELOPMENT, MAINTENANCE, AND OPERATION OF AIRPORT**

**Section 10.1** Operation of Airport. City agrees that it will develop and improve and at all times maintain and operate with adequate and efficient personnel and keep in good repair the Airport (other than the Demised Premises which Airline is required to maintain and repair in accordance with Section 10.5) and the appurtenances, facilities, and services now or hereafter connected therewith, and that it will keep the Airport and its approaches free from obstruction, and will maintain and operate the Airport so as to entitle it to the approved certification and rating by the FAA and all other appropriate regulatory authorities in respect to all present operations of Airline. It is expressly understood that City will keep the Public Space in the Terminal Area in a clean, neat, safe and sanitary condition and attractively furnished and shall be responsible for and shall furnish in the Public Space and the Demised Premises the services and maintenance indicated on **Exhibit C**. It is likewise expressly understood that Airline will perform its responsibilities as indicated on **Exhibit C** in a diligent manner conducive to the best operation of the Airport. City agrees, if and to the extent City is responsible pursuant to **Exhibit C**, to keep, operate and maintain the facilities and space described below in good condition and repair, and in a neat, clean and operating condition, including replacing all worn-out fixtures, furnishings, carpeting and other floor coverings, machinery and equipment as may be required:

(i) the Terminal Area, including, but not limited to, its foundation, structure, outside walls, roof and utility systems;

(ii) the Public Space and Common Use Space in the Terminal Area, including, but not limited to, the lobby, waiting rooms, passageways, nonexclusive baggage handling space (except for baggage conveyor systems owned by Signatory Airlines), public restrooms, elevators and escalators, together with all fixtures, furnishings, and carpeting or other floor coverings located therein; and

(iii) the holdrooms and baggage claim lobbies in the Demised Premises.

**Section 10.2** Shared Use Equipment.

A. City reserves the right to install Shared Use Equipment at all Gates and check-in counters, including Preferential Use Gates, on a position-by-position basis. Airline shall remove any of its computer equipment installed at a Gate or check-in counter upon thirty (30) days written notice from Director. Any such removal of computer equipment installed by Airline during the Term of this Agreement shall be subject to the provisions of Article 18 [Surrender of Possession of Demised Premises].

B. In addition to the foregoing right of City set forth in Section 10.2(A), upon and after reasonable consultation with the RMAC, City shall have the right to install Shared Use Equipment in any other areas of the Airport, including in any Exclusive Use Areas, and require the affected Air Carrier to remove any of its proprietary equipment, if any, and disallow any future installation of proprietary equipment in order to accommodate City's Shared Use Equipment. Any such removal of proprietary equipment from Exclusive Use Premises hereunder shall be subject to the requirements for the removal of trade fixtures pursuant to Article 18 [Surrender of Possession of Demised Premises].

**Section 10.3** Self-Service Devices. Airline may only install proprietary self-service devices for passenger processing at check-in counters within Airline's Exclusive Use Space, which installation shall be subject to the Director's approval, in the Director's sole discretion. Airline shall remove any proprietary self-service devices built within such check-in counters when those counter spaces are later surrendered by Airline or reclaimed by City in accordance with Section 17.8 [Termination for Cessation of Use], Section 7.1 [Recapture of Exclusive Use Space Following Involuntary Reduction in Number of Preferential Use Gates] or Section 7.2 [Recapture of Exclusive Space Following Rejection of Preferential Use Gates], or in the event City elects to install Shared Use Equipment pursuant to Section 10.2(B). Any removal of self-service devices installed during the Term of this Agreement shall be subject to the requirements for the removal of trade fixtures pursuant to Article 18 [Surrender of Possession of Demised Premises].

**Section 10.4** City Owned Equipment; Maintenance Requirements and Operating Standards.

A. City Owned Passenger Loading Bridges and Baggage Handling Systems.

At the election of City in its sole and absolute discretion, Airline will be responsible for equipment maintenance functions on City-owned baggage handling systems, including high-tech maintenance, and passenger loading bridges at Preferential Use Gates, either directly by Airline or through one or more authorized Air Carrier Consortia. City will be responsible for equipment maintenance functions on City-owned passenger loading bridges at Common Use Gates and Swing Gates. Airline will not be responsible for equipment maintenance functions on other City-owned equipment described in Subsection (B) below unless otherwise agreed to by the parties.

B. Other City-Owned Equipment and Systems. Unless otherwise agreed to by the parties, City will be responsible for equipment maintenance functions on certain other City-owned equipment and systems used by Airline, including but not limited to, centralized baggage handling system monitoring and control systems related to explosive detection equipment, preconditioned air, and ground power and other equipment owned by City as of the Effective Date. City shall have the sole discretion to retain or assign maintenance functions with respect to any new equipment acquired by City after the Effective Date upon consultation with the affected Signatory Airlines.

C. Maintenance Standards. All equipment maintenance functions conducted by Airline under this Section 10.4 will be subject to audit and oversight by City, and will be conducted in accordance with maintenance schedules, record-keeping, reporting and quality standards established by City. Airline will submit for City's approval a maintenance plan to meet City's requirements.

D. Operator Training. City shall determine the training responsibility for any passenger loading bridges, baggage handling systems and other equipment owned by City and used or maintained by Airline or Airline Entity. When Airline is responsible for such training, City reserves the right to approve training content and to audit training records. Airline shall not permit any untrained personnel to operate or maintain any City-owned passenger loading bridges, baggage handling systems or equipment. Airline and any Airline Entity agree to participate in or implement such training on a mandatory basis at the request of City, in its sole and absolute discretion.

E. City Right to Assume Maintenance Functions; Other Airline Obligations. City reserves the right for any reason, in its sole and absolute discretion, to assume equipment maintenance functions for any and all City-owned, newly installed or existing equipment used by Airline, including, without limitation, passenger loading bridges and baggage handling systems. In addition, City reserves the right for any reason, in its sole and absolute discretion, to assume any other obligations of Airline under this Section 10.4 and charge Airline for the reasonable cost thereof (to the extent not already charged under Airline Rates and Charges).

**Section 10.5** Condition of Demised Premises and Janitorial Services. Except as otherwise set forth in Section 10.1 and Exhibit C, as to all Exclusive Use Space, Preferential Use Space and other Demised Premises (including Joint Use Space, other than holdrooms and



baggage claim lobbies), Airline agrees to repair and maintain, at its own expense, such Demised Premises, including the fixtures and equipment which are a part thereof, in a clean, neat, safe and sanitary condition, and in good order, at all times, except for damages or loss due to reasonable wear and tear, fire or other casualty or other cause beyond Airline's control, and to redecorate and paint the interior of the Demised Premises and replace electric light bulbs, worn carpeting or other floor coverings, curtains, draperies, blinds or other furnishings and equipment as their conditions may require. All waste matter shall be stored in compliance with applicable Environmental Laws and Airport Rules, and Airline agrees to arrange for the daily disposal, at its expense, of all waste material, except in the case of special agreement with Director. All lawful requirements of the County or State Board of Health, relating to health or sanitary regulation, shall be fully met by Airline, and Airline upon request shall give access for inspection purposes to any duly authorized representative of said legal authority or of City. Unless furnished by an authorized Air Carrier Consortium, and except as otherwise set forth in **Exhibit C**, janitorial services, pest control, carpet cleaning, maintenance and repair, and window washing on the Demised Premises will be furnished by Airline. Airline expressly waives all rights to make repairs at the expense of City, to vacate the Demised Premises, or to terminate this Agreement for failure by City to keep the Demised Premises in good order, condition or repair as provided for in Sections 1941 and 1942 of the California Civil Code.

**Section 10.6** Airline Improvements.

A. Airline shall, at its sole expense, install all Alterations which Airline deems necessary for the use of the Demised Premises and which are not supplied by City. Airline shall not make or suffer to be made any Alterations without Director's prior written consent. Airline shall cause all such Alterations to be performed in a workmanlike manner, in compliance with the requirements of the Airport TI Guide, the Airport Building Regulations and Section 10.7. Any all and all Alterations may be subject to the approval of BICE, the Airport's Design Review Committee and the Infrastructure Review Committee. Prior to the construction of any Alterations, Airline shall submit detailed plans and specifications to the Director for approval, in the form reasonably designated by Airport, which may be part of or on an electronic or other digital platform. Airline shall include with its plans and specifications schematic renderings of the common area, materials, and a color board. Director's approval rights will extend to and include aesthetic matters, as well as to conformance with the Commission's established architectural design scheme for the Airport, and City reserves the right to reject any designs submitted and to require Airline to resubmit designs until they meet Director's approval. In the event of disapproval by City of any portion of the plans and specifications, Airline will promptly submit necessary modifications and revisions thereof. No changes or alterations will be made in said plans or specifications after approval by Director. City agrees to act within a reasonable period of time upon such plans and specifications and upon requests for approval of changes or alterations in said plans or specifications. One copy of plans for all proposed Alterations will, within fifteen (15) days after approval thereof by Director, be signed by Airline and deposited with City as an official record thereof. All Alterations shall be effected through the use of contractors approved by Director who shall furnish to Director upon demand such completion bonds and labor and material bonds as Director may require so as to assure completion of the Alterations on a lien-free basis. Upon completion of the Alterations, Airline shall provide City

with as-built drawings of the Demised Premises in a form reasonably satisfactory to City (i.e., electronic format).

B. Airline shall obtain and pay all fees for building, mechanical, electrical and plumbing permits and like permits required by any legal authority having competent jurisdiction for any improvements or additions requiring construction in the Demised Premises. Airline shall, upon request of Director, exhibit to City all certificates and permits required by the laws of any legal authority having jurisdiction. Airline agrees to give City advance written notice, which, except in the case of emergency repairs, shall be given at least three (3) days before commencing any construction, alteration or repairs on the Demised Premises in order that City may post appropriate notices of non-responsibility. Airline agrees that such notices may remain posted on the Demised Premises until completion and acceptance of such work. Airline shall also conduct a pre-construction conference with City before commencing any Alterations in the Demised Premises.

C. Except as provided in Article 18, any Alterations of the Demised Premises, except movable furniture and trade fixtures, shall at once become a part of the realty and belong to City and shall be surrendered with the Demised Premises at the expiration of the Term hereof or any extension thereof, or upon earlier termination as provided for herein. Upon surrender of the Demised Premises, Airline shall provide City with current as-built drawings of the Demised Premises or shall reimburse City for the cost of creating such as-built drawings.

D. If and to the extent that Airline's activities or proposed Alterations trigger an obligation or requirement on the part of City to make changes to the Airport premises (including ADA and ACAA requirements), Airline shall indemnify, defend, and hold harmless City from and against any and all losses, costs, claims and liabilities arising out of such activities or Alterations.

E. City reserves the right, in its sole and absolute discretion, to require Airline to remove any Alterations installed by Airline without compliance with the terms and conditions of this Section 10.6, at the sole cost and expense of Airline.

**Section 10.7** Reporting of Damage to Airport Property. Neither Airline nor any Airline Entity shall destroy or cause to be destroyed, injure, deface, or disturb in any way, property of any nature on the Airport, nor willfully abandon any personal property on the Airport. If Airline or Airline Entity is aware of any injury, destruction, damage or disturbance of property on the Airport (regardless of responsibility therefor), Airline shall file a written report with City describing the incident and damage within twenty-four (24) hours after discovery, and, if such damage was caused by Airline or any Airline Entity, upon demand by the Director, shall reimburse the City for the full amount of such damage within sixty (60) days. Failure to file any written reports required by this Section shall constitute an Event of Default under this Agreement and a violation of Airport Rules subject to fines under Section 17.7, as applicable.

**Section 10.8** Audit of Operations.

A. Director may cause the Airline's operations under this Agreement to be audited at any time and from time to time, with reasonable advance written notice and at a

mutually agreeable time, and in the presence of Airline or its representative, to confirm that such operations comply with the requirements set forth in this Agreement. Airline shall cooperate with such audit. Airline shall be provided the opportunity to review and comment on the findings of such audit prior to finalization. In the event such audit shows that Airline is not complying with such requirements, without limiting City's ability to call an Event of Default, City may require that Airline reimburse City for the costs of such audit. Airline shall promptly remedy any noncompliance shown in any such audit.

B. This Section 10.8 shall not govern inspections or audits for compliance with Environmental Laws. Such inspections and audits are subject to the provisions set forth in Section 22.2 and Section 22.5, respectively.

**Section 10.9** Trespass and Security. Airline shall use reasonable precautions to prevent unauthorized persons from gaining access to restricted flight and public aircraft operational areas and all other nonpublic areas of the Airport. Further, Airline and Airline Entities shall comply with security measures (a) required of Airline by the FAA, TSA or City in accordance with applicable requirements of the FAA or the TSA or the City or their authorized successors, or (b) contained in any Airport master security plan approved by the FAA, TSA or City or their authorized successors. If Airline or any Airline Entity shall fail or refuse to comply with said measures and such non-compliance results in a monetary penalty being assessed against City, Airline shall be responsible for and shall reimburse City in the full amount of any such monetary penalty or other damages, in addition to other penalties or remedies available to City under this Agreement.

**Section 10.10** Compliance with Applicable Laws. Airline shall promptly, at its sole expense, cause Airline's use of the Airport and operations therein to comply at all times with all Applicable Laws, as the same may be amended from time to time, including, without limitation, (a) all Applicable Laws relating to health and safety, disabled access, including the ADA and the ACAA, (b) the Airport Building Regulations, (c) the Airport Rules, and (d) Environmental Laws. Airline shall also promptly, at its sole expense, cause the Demised Premises and related equipment to comply with all applicable Airport Building Regulations and Airport Rules to the extent such portions of the Demised Premises and/or equipment are deemed an Airline responsibility pursuant to **Exhibit C** attached hereto. The parties acknowledge and agree that such obligations are a material part of the bargained for consideration under this Agreement. Any work or installations made or performed by or on behalf of Airline or any person or entity claiming through or under Airline on the Demised Premises shall be subject to and performed in compliance with the provisions of this Agreement, including this Section. Airline shall keep current all licenses and permits, required under any Applicable Law for conduct of its operations at Airport, and pay all fees promptly when due. Airline shall promptly upon reasonable request provide City with evidence of its compliance with any of the obligations of this Section.

**Section 10.11** Accessibility Disclosure. California Civil Code Section 1938 requires commercial landlords to disclose to tenants whether the property being leased has undergone inspection by a Certified Access Specialist ("**CASp**") to determine whether the property meets all applicable construction-related accessibility requirements. The law does not require landlords to have the inspections performed. Airline is hereby advised that the Demised Premises have not

been inspected by a CASp. Pursuant to California Civil Code Section 1938(e), City, as owner, provides the following disclosure to Airline, as tenant: “A Certified Access Specialist (CASp) can inspect the subject premises and determine whether the subject premises comply with all of the applicable construction-related accessibility standards under state law. Although state law does not require a CASp inspection of the subject premises, the commercial property owner or lessor may not prohibit the lessee or tenant from obtaining a CASp inspection of the subject premises for the occupancy or potential occupancy of the lessee or tenant, if requested by the lessee or tenant. The parties shall mutually agree on the arrangements for the time and manner of the CASp inspection, the payment of the fee for the CASp inspection, and the cost of making any repairs necessary to correct violations of construction-related accessibility standards within the premises.” In the event Airline elects to obtain a CASp inspection of the Demised Premises, Airline shall provide notice of such to City, and Airline agrees that Airline shall bear the cost of the inspection and any necessary repairs within the Demised Premises.

**Section 10.12** **Trash Removal.** Airline shall at all times cause the Demised Premises and the areas around the Demised Premises to be clean, sightly and free from trash. Airline shall not store nor allow accumulation of trash or debris on the Demised Premises, any Public Space or Common Use areas used by Airline, nor use City’s trash containers without Director’s prior written consent. Airline shall provide its own trash containers for its use. As provided in **Section 17.3**, in the event that Airline fails to perform the aforementioned obligations, the Airport shall have the right to do so, at Airline’s expense. For the avoidance of doubt, all such trash disposal, containment and removal shall comply with all Applicable Laws and Airport Rules with respect to recycling, composting and other sustainability requirements.

**Section 10.13** **Taxes.** Airline recognizes and understands that this Agreement may create a possessory interest subject to property taxation and that Airline may be subject to the payment of property taxes levied on such interest. Airline further recognizes and understands that any Transfer permitted under this Agreement and any exercise of any option to renew, or other extension of this Agreement may constitute a change in ownership for purposes of property taxation and therefore may result in a revaluation of any possessory interest created hereunder. Airline shall pay all taxes of any kind, including possessory interest taxes, that may be lawfully assessed on the real property interest hereby created and pay all other taxes, excises, licenses, permit charges and assessments based on Airline’s usage of the Demised Premises, all of which shall be paid when the same become due and payable and before delinquency.

Airline shall report any Transfer, or any renewal or extension hereof, to the County of San Mateo Assessor within sixty (60) days after such Transfer, renewal, or extension. Airline further agrees to provide such other information as may be requested by the City within sixty (60) days of said request to enable the City to comply with any reporting requirements under applicable law with respect to possessory interests.

**Section 10.14** **Other Liens.** Airline shall not permit or suffer any liens to be imposed upon the Airport or any part thereof, including without limitation, mechanics, materialmen’s, and tax liens, as a result of its activities without promptly discharging the same. Notwithstanding the foregoing, Airline may in good faith contest any such lien if Airline provides a bond in an amount and form acceptable to City in order to clear the record of any such liens. Airline shall

assume the defense of and indemnify and hold City harmless against any and all liens and charges of any and every nature and kind which may at any time be imposed upon the Airport or any part thereof as a consequence of any act or omission of Airline or as a consequence of the existence of Airline's interest under this Agreement.

**Section 10.15** Air Carrier Consortia. City acknowledges that a group of Air Carriers may desire to form an Air Carrier Consortium to perform Air Carrier Consortium Services at the Airport or, from time to time, to modify the scope of Air Carrier Consortium Services provided by an Existing Air Carrier Consortium. In such event, City will negotiate in good faith with the applicable Air Carriers, and the City will not unreasonably withhold, condition or delay its consent to such formation of an Air Carrier Consortium or such modification of the scope of Air Carrier Consortium Services of any Existing Air Carrier Consortium. Notwithstanding the foregoing, it shall be reasonable for the City to withhold its consent to the formation of an Air Carrier Consortium or modification of the scope of Air Carrier Consortium Services of an Existing Air Carrier Consortium if the following requirements and limitations are not satisfied (collectively, the "**Air Carrier Consortium Requirements**"), provided that the Air Carrier Consortium Requirements set forth below shall not be considered an exhaustive list, and City reserves the right to consider and require additional requirements as operational, safety, security, business or legal considerations may warrant, in the reasonable discretion of City:

- (i) the function of the Air Carrier Consortium and scope of the Air Carrier Consortium Services, or any modifications to the same, shall be clearly defined and mutually acceptable to City and the Air Carriers;
- (ii) the Air Carrier Consortium Services are permitted to be performed only on a non-exclusive basis, and City and any Air Carriers that are not members of the Air Carrier Consortium shall retain the ability to perform such services on their own behalf;
- (iii) Air Carriers, including Air Carriers that are not members of the Air Carrier Consortium, shall be permitted to use Air Carrier Consortium Services on terms that are reasonable and not unjustly discriminatory, including terms covering reasonable costs for such services;
- (iv) to the extent that the Air Carrier Consortium intends to cause any of the Air Carrier Consortium Services to be performed by a third party contractor, at City's election, the procurement process may be subject to City approval;
- (v) through its representation on the governing board of any Air Carrier Consortium, City, at its election, may be consulted on and participate in the selection of key personnel and contractors, equipment or infrastructure implementations, and adoption of project costs and budgets;
- (vi) City shall have approval rights over service standards and service level agreements, and such service level agreements shall be subordinate to the rights of City such that City shall have the express right to require the termination of the same and impose fees in the event the same are not being performed in accordance with applicable

service level standards or otherwise to the reasonable satisfaction of City, and recapture and carry out all or any portion of the Air Carrier Consortium Services, provided that City is able to perform such services to the same standards required under the service level agreement; and

(vii) City shall, at City's option, have sufficient representation on the governing body of any Air Carrier Consortium, as reasonably determined by City, provided that City shall not have voting rights over internal consortium matters not affecting assets of City, operations of the Airport or the guest experience at the Airport. Examples of matters for which City will not have voting rights include internal operating budgets and salaries of employees of the Air Carrier Consortium which are not key personnel.

## **ARTICLE 11. DAMAGE AND DESTRUCTION; CONDEMNATION**

### **Section 11.1 Damage and Destruction.**

A. Damage. If any portion of the Terminal in which Airline occupies Demised Premises under this Agreement is damaged by fire, earthquake, or other casualty, but is not rendered unfit for use by Airline, the damage shall be repaired by City. If the damage renders the Demised Premises unfit for use by Airline, and if the damage is repairable using reasonable diligence within four (4) months from the date of the occurrence, the Premises shall be repaired by City, subject to Subsection (D) below with respect to Airline's repair of its Alterations.

B. Destruction.

(i) If any portion of the Terminal in which Airline occupies Demised Premises under this Agreement is completely destroyed by fire, earthquake or other casualty, or damaged to such extent that such damage cannot be repaired within four (4) months from the date of the occurrence, City shall have the option to terminate this Agreement to the extent that it shall apply to the particular affected Demised Premises. City shall within thirty (30) days of such occurrence provide written notice to Airline that it intends to (i) terminate the Agreement with respect to the affected Demised Premises or (ii) repair or reconstruct the Demised Premises. If City elects to repair or reconstruct the Demised Premises, subject to Subsection (E) below with respect to Airline's repair of its Alterations, it shall begin any work necessary to do so and shall use reasonable efforts to provide the Airline with temporary substitute space while the repairs are being completed. If City elects to terminate this Agreement, such termination shall be effective as to the Demised Premises sixty (60) days after the occurrence of the damage, provided, however, that before electing to terminate, upon request of Airline, City shall use reasonable efforts to provide Airline with substitute space for the remaining Term. City may charge the applicable rental rate for any temporary or substitute space it furnishes.

(ii) In the event that City shall elect to terminate the Agreement as to the portion of the Demised Premises damaged or destroyed as provided above, and in the event the loss of use thereof by the Airline will have a substantial adverse effect on Airline's use of the remainder of the Demised Premises and its business and operations at

the Airport, Airline may within thirty (30) days after receipt of City's notice of termination, terminate this Agreement in its entirety by giving City written notice thereof.

C. Rent Abatement. For the period from the occurrence of any damage to the Demised Premises to the date of completion of the repairs to the Demised Premises (or to the date of termination of the Agreement as to such portions of the Demised Premises if City shall elect not to restore them), the rental allocable to the particular Demised Premises involved shall be abated in the same proportion as the unusable portion of the Demised Premises bears to the whole, or, if the damage or destruction has rendered the entire Demised Premises unusable, said rental shall be abated entirely, and upon termination of the Agreement as to such damaged or destroyed Demised Premises, the Airline shall have no further obligation to pay the rental allocable thereto. The costs assigned to such unusable Demised Premises under this Section 11.1(C) shall be subject to rate recovery under Articles 4 and 5 and Exhibit O.

D. Airline's Remedies. If the Demised Premises is wholly or partially destroyed or damaged, Airline shall have no claim against City for any damage suffered by reason of any such damage, destruction, repair or restoration. Airline waives California Civil Code Sections 1932(2) and 1933(4) providing for termination of hiring upon destruction of the thing hired, and Airline expressly acknowledges and agrees that the terms and conditions of this Agreement shall control.

E. Allocation of Responsibility for Reconstruction. In the event any Alterations in the Exclusive Use Space or Preferential Use Space included in the Demised Premises are to be reconstructed or repaired following damage by any casualty described in Sections 11.1(A) or (B) or above, Airline shall repair such damage to its Alterations, at its sole cost and expense, and this Agreement shall continue in full force and effect. In the event such damage occurs to Alterations in Exclusive Use Space or Preferential Use Space that is open or available to the public, Airline shall use commercially reasonable efforts to cause such repair to be performed within ninety (90) days. If the damage occurs to Alterations in Exclusive Use Space or Preferential Use Space that is not open or available to the public, Airline shall use commercially reasonable efforts to cause such repair to be performed within one hundred and eighty (180) days.

## Section 11.2 Condemnation/Eminent Domain.

A. If all or a substantial part of the Demised Premises shall be taken or condemned by any competent authority through exercise of its power of eminent domain or other authority justifying such taking, Airline may terminate this Agreement upon thirty (30) days' notice, and the rents, fees and charges in respect of the Demised Premises shall cease as of the date possession is taken by the taking authority, if City does not notify Airline in writing within sixty (60) days before the date of taking that it will provide Airline with mutually acceptable substitute facilities.

B. If a portion of the Demised Premises shall be so taken, Airline shall have the right, exercisable at its sole discretion, to request City to amend this Agreement to remove the Demised Premises so taken upon thirty (30) days' notice, if City does not notify Airline in

writing within sixty (60) days before the date of taking that it will provide Airline with mutually acceptable substitute facilities.

C. City shall be entitled to all damages payable by reason of a taking, (including, but not limited to, any portion of such damages made for the value of the leasehold estate created by this Agreement and any Alterations), and Airline shall have no claim against City for the value of any unexpired term of this Agreement, provided that Airline may make a separate claim for compensation, and Airline shall receive any damages made specifically to Airline, for Airline's relocation expenses or the interruption of or damage to Airline's business or damage to Airline's movable personal property.

## **ARTICLE 12. RULES AND REGULATIONS**

The use by Airline of the areas and facilities described herein and the rights and privileges granted Airline pursuant to this Agreement shall at all times be subject to the provisions of this Agreement and any and all reasonable rules, regulations, orders and directives of the Airport, including, without limitation, the Airport TI Guide, the Airport Building Regulations, Airport Rules and Regulations, Airport Operation Bulletins and Airport Security Directives, as may be established and amended from time to time by City (collectively "**Airport Rules**"); provided that (a) the Airport Rules and Regulations must be reasonable, not unjustly discriminatory, and not in conflict with any controlling federal, state or local laws or regulations and (b) in the event that any Airport Rule and Regulation conflicts with any term or provision of this Agreement, the term or provision of this Agreement shall prevail. Airline covenants and agrees that it will not violate or permit any Airline Entity to violate any Applicable Laws. In addition to the foregoing, within a reasonable time period prior to the adoption of any new Airport Rules and Regulations by the Commission, City agrees to consult with representatives of the Signatory Airlines to provide an opportunity for them to review and comment on the same, provided that the formulation and adoption of the same remains in the sole and absolute discretion of the Airport Commission. City may prescribe civil penalties and injunctive remedies for violations thereof, and the same may be applied to Airline for violations by Airline or any Airline Entity. Nothing herein contained shall be deemed to prevent Airline from contesting in good faith any Applicable Laws, Airport Rules or any other rule or regulation of the City or Commission without being considered in breach of this Agreement so long as such contest is diligently commenced and prosecuted by Airline, and provided that Airline is complying with the Applicable Law or Airport Rule in question during the contest of the same.

## **ARTICLE 13. NO OTHER CHARGES, QUIET ENJOYMENT**

### **Section 13.1 No Other Charges.**

A. The City agrees no rates, fees, or charges, other than as provided in this Agreement may be imposed or collected by the City from Airline. The City may not impose fees or charges to a vendor supplying services to Airline for the privilege of providing services to Airline; however, the vendor must pay all other reasonable and non-discriminatory rates, fees, or charges that may be imposed by the City or other governmental authority in connection with the vendor's business at the Airport. Notwithstanding the foregoing, to the extent permitted by Applicable Laws, City shall not be prohibited now or in the future from imposing one or more



tolls or fee structures chargeable to the general public, ground transportation operators and other users for the use of roadways owned by City leading to, from, around and through the Airport, the revenue of which will be deemed to be Non-Airline Revenue and applied to the Access & Roadways Area Center.

B. The City expressly reserves the right to impose PFCs in accordance with 49 U.S.C. § 40117 and applicable implementing regulations adopted by the FAA, 14 CFR Pt. 158, as they may be amended from time to time (the “**PFC Regulations**”). Airline shall hold in trust for the City the net principal amount of all PFCs that are collected by Airline or its agents on behalf of the City pursuant to 49 U.S.C. § 40117 and the PFC Regulations. For purposes of this Section 13.1, net principal amount shall mean the total principal amount of all PFCs that are collected by Airline or its agents on behalf of the City, reduced by any amount that Airline is permitted to retain pursuant to § 158.53(a) of the PFC Regulations.

**Section 13.2** Quiet Enjoyment. City represents that it has the right to lease said Demised Premises together with all the premises and facilities, easements, rights, licenses, and privileges herein granted, and has full power and authority to enter into this Agreement in respect thereof; and City further covenants that Airline shall peaceably have and enjoy said Demised Premises and the premises and facilities, easements, rights, licenses, and privileges for the Term of this Agreement.

#### **ARTICLE 14. LIMITED OBLIGATIONS, INDEMNITY, WAIVER AND INSURANCE**

**Section 14.1** Limited Obligations of City. Any obligation or liability of City created by or arising out of this Agreement shall be payable solely out of the Revenues and other lawfully available moneys of the Airport and shall not constitute a general obligation of City or a charge upon its general fund. This Agreement shall not obligate City to make any appropriation from its general fund for any payment due hereunder. No breach by City hereunder shall impose any pecuniary liability upon City, other than from Revenues, or be payable from or constitute a charge upon the general credit or against the taxing power of City.

**Section 14.2** Indemnity, Waiver.

A. Airline agrees to protect, defend, reimburse, indemnify and hold and save City and each City Entity, free and harmless at all times from and against any and all claims, liability, expenses, losses, costs, fines and damages (including actually incurred reasonable attorney’s fees and costs) and causes of action of every kind and character, whether or not meritorious, against or incurred by City by reason of any damage to property or bodily injury (including death) incurred or sustained by any party hereto, any agent or employee of any party hereto, and any third or other party whomsoever or any governmental agency, arising out of or incident to or in connection with the performance, non-performance or purported performance of Airline or any Airline Entity under this Agreement, or any breach of the terms of this Agreement by Airline or any Airline Entity; Airline’s or any Airline Entity’s use or occupancy of the Demised Premises; or Airline’s or any Airline Entity’s negligent acts, omissions or operations hereunder; provided, however, that Airline shall not be so obligated to protect, defend, reimburse, indemnify and hold City free and harmless if the applicable claim, liability, expense, loss, cost, fine, damage or cause of action is caused (i) by the gross negligence or the willful

misconduct of the City or any City Entity; (ii) by the existence of Hazardous Materials on the Demised Premises caused solely by a third party other than an Airline Entity; or (iii) by a Pre-Existing Condition for which Airline is not liable under Section 22.4. Upon the filing by anyone of a claim with City for damages arising out of incidents for which Airline is obligated herein to indemnify and hold City harmless, City shall promptly notify Airline of such claim and, in the event that Airline does not settle or compromise such claim, Airline shall undertake the legal defense of such claim both on behalf of Airline and on behalf of City. It is specifically agreed, however, that City, at its option and at its own expense, may participate in the legal defense of such claim. Any final judgment against City from which no appeals remain for any cause for which Airline or Airline Entity is liable hereunder shall be conclusive against Airline or Airline Entity as to liability and amount upon the expiration of the time for appeal therefrom. Airline recognizes the broad nature of this indemnification and hold harmless clause and voluntarily makes this covenant and expressly acknowledges that the terms and conditions of this Agreement constitute good and valuable consideration provided by City in support of this indemnification in accordance with laws of the State.

B. Airline, as a material part of the consideration to be rendered to City under this Agreement, hereby waives all claims or causes of action against City, its officers, or employees which it may have for damages to any property on, about, or related to the Airport, and for injuries or death to persons on, about, or related to the Airport, from any cause or causes arising during the term of this Agreement, except as otherwise set forth in the last sentence of this Subsection (B). By way of example and not limitation, Airline hereby waives any and all claims or causes of action which it may hereafter have against City, its officers, or employees (a) for loss, injury, or damage sustained by reason of any deficiency, impairment, and interruption of any water, electrical, gas, plumbing, air conditioning, ventilation, Information and Communications Technology, Shared Use Equipment or sewer service or system serving any portion of the Airport, or failure or interruption of any public or passenger conveniences; (b) for any loss, injury, or damage arising or resulting from any act or neglect or omission of any other tenant, subtenant, permittee, concessionaire, or occupant of the Airport, or any person who uses the Airport with authorization or permission of the City (City agrees to use commercially reasonable efforts to control tenants, subtenants, permittees, concessionaires, occupants, or Airport users to prevent loss, injury, or damage); and (c) for any loss or damage to the property of, or injury or damage to Airline, its officers, employees, agents, contractors, or any other person whomsoever, from any cause or causes arising at any time because of Airline's use or occupancy of the Demised Premises or of the Airport, or its operations thereon (City will use commercially reasonable efforts to control the activities of other users); and (d) for loss, injury, or damage sustained by reason of any act of terrorism. Notwithstanding the foregoing, nothing in this Section shall relieve City from liability to Airline caused solely and directly by the gross negligence or willful misconduct of City or a City Entity, but City shall not be liable under any circumstances for any consequential, incidental or punitive damages.

C. The parties hereto expressly agree that no provision of this Section shall in any way limit, modify, diminish, or otherwise affect the rights, claims, suits, judgments, or causes of action that either party may at any time have (or have had) against the other party (whether for contribution, indemnity, or otherwise) arising out of, resulting from, or related to Airline's noise, smoke, or vibration.

D. This Section shall survive the termination of this Agreement as to claims arising during the Term thereof. Compliance with the insurance requirements of this Article 14 shall not relieve Airline of its liability or obligation to indemnify City as set forth in this Article 14.

**Section 14.3** Public Liability and Property Damage Insurance.

A. Without in any way limiting Airline's liability under Section 14.2, Airline, at its sole cost and expense, shall obtain and maintain in force, during the full Term of this Agreement, insurance in the following minimum amounts and coverages:

(i) An Aircraft Liability policy, with coverage of not less than \$500,000,000 combined single limit for bodily injury and property damage, which shall include but not necessarily be limited to all of the following coverages: Aircraft Liability, including General Liability, Aircraft Products and Completed Operations, Liquor Liability, Personal Injury, Premises Liability, Products & Completed Operations, Contractual Liability, Hangarkeepers Liability, Motor Vehicle Liability within the secured side of the Airport, Cargo Legal Liability, and if such operations are conducted by Airline, Fueling and Refueling. With respect to coverage for personal injury for non-passengers, any such sublimits shall not be less than \$25,000,000 per occurrence, and in the aggregate.

(ii) At least \$100 million War and Named (Allied) Perils coverage for bodily injury and property damage, each occurrence and annual aggregate, or the U.S. Government equivalent.

(iii) Workers' Compensation, in statutory amounts, with Employers' Liability Limits not less than \$1,000,000 each accident, injury or illness and a Voluntary Compensation Endorsement.

(iv) A Commercial Automobile Liability Insurance with limits not less than \$10,000,000 each occurrence, Combined Single Limit for Bodily Injury and Property Damage, Owned, Non-Owned/Hired auto coverage, as applicable. Any and all mobile equipment, including cranes, which is not covered under the Commercial Automobile Liability Insurance policy shall have said coverage provided for under the Comprehensive General Liability policy required above.

(v) Property Insurance in an amount equal to "Value of Airline Improvements and Betterments" during the course of construction and after completion. Coverage shall include Replacement Value, covering Airline improvements and betterments, for Fire & Extended Coverage, including Sprinkler Leakage, Vandalism & Malicious Mischief, and Debris Removal.

(vi) If applicable to any provided operations, Airline must provide Technology Errors and Omissions Liability coverage, with limits of \$1,000,000 for each claim and each loss. The policy shall at a minimum provide coverage for the following risks:

(1) Network security liability arising from the unauthorized access to, use of, or tampering with computers or computer systems, including hacker attacks; and

(2) Liability arising from the introduction of any form of malicious software including computer viruses into, or otherwise causing damage to the City's or third person's computer, computer system, network, or similar computer related property and the data, software, and programs thereon.

(vii) Cyber and Privacy Insurance with limits of not less than \$1,000,000 per claim. Such insurance shall include coverage for liability arising from theft, dissemination, and/or use of confidential information, including but not limited to, bank and credit card account information or personal information, such as name, address, social security numbers, protected health information or other personally identifying information, stored or transmitted in electronic form.

(viii) Pollution Liability Insurance applicable to Airline's activities and responsibilities under this Agreement with limits not less than \$10,000,000 each occurrence combined single limit, including coverage for on-site third party claims for bodily injury and property damage.

B. All deductibles or the provision of self-insurance must be disclosed by Airline to City and are subject to the reasonable determination of City's Risk Manager for appropriateness.

C. Except for U.S. government equivalent War and Named (Allied) Perils coverage, Workers Compensation/Employer's Liability Insurance and Property Coverage, the insurance policies shall contain, or be endorsed to contain, the following provisions:

(i) City and County of San Francisco, its Officers, Agents, Employees, and Contractors shall be covered as additional insureds to the extent of Airline's indemnity obligations under this Agreement. The coverage shall contain no special limitations on the scope of protection afforded to City, its Officers, Agents, Employees, and Contractors.

(ii) such policies are primary insurance to any other insurance available to the additional insureds, with respect to any claims arising out of this Agreement, and that the insurance applies separately to each insured against whom claim is made or suit is brought, except at the limits of the insurer's liability.

D. The Worker's Compensation policy(ies) shall be endorsed with a waiver of subrogation in favor of the City for all work performed by the Airline, its employees, agents and subcontractors.

E. Any failure to comply with reporting provisions of the policies shall not affect coverage provided to City, its Officers, Agents, Employees, and Contractors.

F. Reserved.

G. City shall retain the right at any time to review the coverage, form, and amount of the insurance required hereby. If, in the opinion of City, the insurance provisions in this Agreement do not provide adequate protection for City and/or for members of the public, City may require Airline to obtain insurance sufficient in coverage, form, and amount to provide adequate protection. City's requirements shall be commercially reasonable but shall be designed to assure protection from and against the kind and extent of risk which exists at the time a change in insurance is required (provided such protection is available on commercially reasonable terms), and Airline agrees to provide same within thirty (30) days of receiving notice from City.

H. Provisions of this paragraph as to maintenance of insurance shall not be construed as limiting in any way the extent to which Airline may be held responsible for the payment of damages to persons or property resulting from its activities or of any person or persons for which it is otherwise responsible.

I. Thirty (30) days' advance written notice shall be provided to the City of cancellation, intended non-renewal, or reduction in coverages (notwithstanding the foregoing, the notice period for War Risks and Named (Allied) Perils insurance may be seven (7) days or such lesser period as may be customarily available, and the notice period for cancellations due to non-payment of premium for the Property, Worker's Compensation/Employers Liability, and Commercial Business Auto policies shall be ten (10) days), except for non-payment for which no less than ten (10) days' notice shall be provided to City.

J. Insurance is to be placed with insurers with sufficient financial strength, rating and solvency acceptable to City's Risk Manager.

K. Airline shall furnish City with certificates of insurance, and "Additional Insured" endorsements where appropriate, as required by this clause. The certificates for each insurance policy shall be signed by a person authorized by that insurer to bind coverage on its behalf.

L. Proof of insurance in the form required by this Agreement shall be submitted to City in the manner requested by City, which may include electronic submission to City or its designee, or in lieu of electronic submission, City may require submission by U.S. mail.

M. Airline shall either self-insure (by establishing reserves in accordance with accepted accounting practices) or procure and keep in force fire and extended coverage insurance upon its leasehold improvements located at the Airport, to the full replacement cost, insurable value thereof and shall furnish City, upon execution of this Agreement, with evidence that such self-insurance reserves have been established or such coverage has been procured and is being maintained in full force and effect. Said evidence of insurance shall be endorsed to require thirty (30) days written notice to City of cancellation or adverse material change and to provide that any insurance carried by City be excess insurance only.

N. City and Airline agree to have all property insurance carried with respect to the Airport, the Demised Premises or any property therein endorsed with a clause that waives all rights of subrogation that the insurer of one party may have against the other party hereto. To that effect, City and Airline will respectively employ diligent efforts to cause their insurance companies to endorse the affected property insurance policies with a waiver of subrogation clause as required herein.

O. Should any of the required insurance be provided under a claims-made form, Airline shall maintain such coverage continuously throughout the term of this Agreement and, without lapse, for a period of three years beyond the expiration of this Agreement, to the effect that, should occurrences during the Agreement term give rise to claims made after expiration of the Agreement, such claims shall be covered by such claims-made policies.

P. Should any of the required insurance be provided under a form of coverage that includes a general annual aggregate limit or provides that claims investigation or legal defense costs be included in such general annual aggregate limit, such general annual aggregate limit shall be double the occurrence or claims limits specified above.

## ARTICLE 15. SECURITY DEPOSIT

### **Section 15.1** Security for Faithful Performance.

A. Security. The full and faithful performance of the Lease and Use Agreement by each Signatory Airline, including this Agreement by Airline, including, but not limited to, the payment of all Terminal Area Rentals, Landing Fees, Usage Fees, Airline Rates and Charges now or in the future payable to City hereunder, and the compensation for any loss or damages the City may suffer by a default hereunder or breach or rejection hereof, shall be secured by the Deposit provided in accordance with Section 15.2 by such Signatory Airline, including Airline.

B. Other Agreements. From time to time, Signatory Airlines, including Airline, have entered or may enter into other agreements with City under which Signatory Airlines, including Airline, may provide additional security deposits in accordance with such agreements.

### **Section 15.2** Deposit/Faithful Performance Bond.

A. Applicability. The provisions of this Section shall be applicable to all Signatory Airlines, including Airline.

B. Nature of Deposit. Prior to the Effective Date, Airline will deliver to Director the Deposit in the Deposit Amount. Such Deposit shall be in the form of (a) a surety bond payable to City, naming City as obligee, and otherwise in form satisfactory to City's City Attorney, and issued by a surety company satisfactory to Director, or (b) an irrevocable letter of credit naming City as beneficiary, and otherwise in form satisfactory to City's City Attorney, issued by a bank satisfactory to Director. Such bond or letter of credit shall be renewed annually at Airline's cost ("**Annual Renewal Requirement**") and shall be kept in full force and effect at

all times to ensure the faithful performance by Airline of all covenants, terms, and conditions of this Agreement between City and Airline, including payment of rent and Landing Fees. Airline shall cause the surety company or bank issuing such bond or letter of credit to give Director notice in writing by registered mail at least forty-five (45) days prior to the expiration date or termination of such bond or letter of credit of its intention not to renew said bond or letter of credit or to terminate said bond or letter of credit.

C. Draws upon Deposit. If Airline fails to pay any Terminal Area Rentals, Landing Fees, usage fees, rates and charges now or in the future payable to City hereunder, or otherwise defaults with respect to any provision of this Agreement, City may use, apply or retain all or any portion of the Deposit for the payment of such amounts, or for the payment of any other sum to which City may become obligated by reason of Airline's default or to compensate City for any loss or damages which City may suffer thereby. If City so uses or applies all or any portion of the Deposit, Airline, within ten (10) days after demand therefor, shall deposit other security acceptable to Director with City in an amount sufficient to restore the Deposit to the full amount thereof. In the event the surety company or bank declines to renew or elects to cancel the bond or letter of credit comprising the Deposit, Airline shall, at least thirty (30) days prior to the expiration or cancellation date thereof, replace such bond or letter of credit with another bond or letter of credit. If Airline fails to do so, City may, without notice to Airline, draw on the entirety of the Deposit and hold the proceeds thereof as security hereunder. City shall not be required to keep the Deposit separate from its general accounts. If Airline performs all of Airline's obligations hereunder, the Deposit, or so much thereof as has not theretofore been applied by City, shall be returned, without payment of interest or other increment for its use, to Airline (or, at City's option, to the last assignee, if any, of Airline's interest hereunder) upon the revocation or termination of this Agreement and following Airline's cessation of use of the Demised Premises and Common Use facilities. No trust relationship is created herein between City and Airline with respect to the Deposit.

D. Adjustment of Deposit Amount Every Two Years; Exception. Except as otherwise expressly set forth below, and without negating Airline's obligations to meet the Annual Renewal Requirement, Airline will only have to adjust the Deposit Amount on or before July 1st (or such other date designated by Director) (the "**Deposit Adjustment Date**") every other year during the Term, with the first adjustment (after the making of the Deposit on the Effective Date) occurring on the Deposit Adjustment Date in 2025. Notwithstanding the foregoing, City may require an adjustment of the Deposit Amount on or before the Deposit Adjustment Date in the event either (i) the required Deposit Amount is calculated and reasonably determined by City to have increased by twenty percent (20%) or more over the then existing Deposit Amount or (ii) an Event of Default shall have occurred. Any calculation of the Deposit Amount by City shall be final and binding on Airline, absent manifest error.

E. Failure of Air Carriers to Replenish Deposit. Notwithstanding anything to the contrary contained in this Agreement, upon the default or Event of Default of any Air Carrier operating at the Airport, in the event that City has used, applied or retained all of the Deposit for such Air Carrier, and such Air Carrier fails to either deposit other security with City or provide a replacement bond or letter of credit pursuant to Section 15.2(C), City shall have the sole and absolute discretion on the exercise of any other remedies available to City under the applicable

agreement with such Air Carrier, or any other remedies at law or in equity, without any requirement to consult with or seek the consent of Airline or any other Signatory Airlines, and without any such election to exercise or not exercise remedies constituting a breach of City's obligations under Section 21.7 [Contracting on More Favorable Terms].

## ARTICLE 16. ASSIGNMENT AND SUBLETTING

**Section 16.1** No Transfer. Except as expressly provided herein, Airline shall not Transfer the Demised Premises, this Agreement, or any right hereunder without Director's prior written consent, which consent shall not be unreasonably withheld. Without limiting the generality of the foregoing reasonableness standard, the parties agree that it would be reasonable for Director to deny consent for any Transfer if the proposed transferee does not have adequate financial or operational capacity to perform the assumed obligations under this Agreement. In no event will Director be obligated to consent to any Transfer where the transferor earns a profit or bonus rent. Director's consent to one Transfer shall not be deemed a consent to subsequent Transfers. Any Transfer made without Director's consent shall constitute an Event of Default hereunder and shall be voidable at Director's election.

### **Section 16.2** Changes in Airline Ownership.

A. The merger of Airline with any other entity or the transfer of any controlling ownership interest in Airline, or the assignment or transfer of a substantial portion of the assets of Airline, whether or not located on the Demised Premises shall constitute a Transfer to which the consent requirements in Section 16.1 are applicable. Without limiting the generality of the foregoing, if Airline is a partnership, a withdrawal or change, voluntary, involuntary or by operation of law, of the partner or partners owning fifty-one percent (51%) or more of the partnership, or the dissolution of the partnership, or the sale or transfer of at least fifty-one percent (51%) of the value of the assets of the partnership shall be deemed a Transfer to which the consent requirements in Section 16.1 are applicable. If Airline is a corporation or limited liability company, any dissolution, merger, consolidation or other reorganization of Airline, or the sale or other transfer of a controlling percentage of the capital stock or membership interests of Airline, or the sale or transfer of at least fifty-one percent (51%) of the value of the assets of Airline, shall be deemed a Transfer to which the consent requirements in Section 16.1 are applicable. The phrase "controlling percentage" means the ownership of, and the right to vote, stock or interests possessing at least fifty-one percent (51%) of the total combined voting power of all classes of Airline's capital stock or interests issued, outstanding and entitled to vote for the election of directors. Without limiting the restrictions on asset transfers, this paragraph shall not apply to stock or limited liability company interest transfers of corporations or limited liability companies the stock or interests of which are traded through a public exchange or over the counter. Airline's entering into any operating agreement, license or other agreement where a third party, other than a subsidiary, Affiliate Airline, or code share partner of Airline, is given rights or privileges to use portions of the Demised Premises shall be considered an attempted Transfer to which the consent requirements in Section 16.1 are applicable.

B. Notwithstanding anything set forth herein to the contrary, Airline shall have the right, without first obtaining Director's written consent, to assign or transfer this Agreement and Airline's rights and obligations hereunder, to (i) an entity controlling, controlled



by or under common control with Airline, or (ii) a successor by merger, consolidation or acquisition to all or substantially all of the assets of Airline, if such entity or successor conducts an air transportation business at the Airport and assumes all rights and obligations hereunder. Written notice of such assumption shall be provided by such entity or successor thirty (30) days prior to the effective day of such assignment.

C. Notwithstanding anything set forth herein to the contrary, Airline shall have the right, without first obtaining Director's written consent, to grant a no-fee license to use a portion of the Demised Premises to a ground handler or other service provider as part of a ground handling or services agreement; provided that (i) such ground handler or service provider shall be licensed or permitted by City to operate at the Airport in accordance with Section 2.2(O); (ii) such ground handler or service provider shall acquire no interest or rights in this Agreement or the Demised Premises, and (iii) Airline shall provide City with notice of the license thirty (30) days prior to the effective date thereof.

**Section 16.3** No Release. In no event will Director's consent to a Transfer be deemed to be a release of Airline as primary obligor hereunder.

**Section 16.4** Subleases. In the event that the proposed Transfer is a sublease of any portion of Airline's Demised Premises, without limiting the generality of the foregoing reasonableness standard, the parties agree that it would be reasonable for Director to deny consent if any of the following shall apply: (i) the rental rate plus any other consideration charged to the proposed sublessee is greater than the Terminal Area Rental Rate paid by Airline to City by 15% or more for the proposed subleased premises; or (ii) the proposed sublessee is not an Air Carrier.

## **ARTICLE 17. TERMINATION OR SUSPENSION OF LEASE PROVISIONS**

### **Section 17.1** Airline Events of Defaults and City Remedies.

A. The occurrence of any one or more of the following events shall constitute a breach of this Agreement and an "**Event of Default**" hereunder:

(i) Airline shall fail duly and punctually to pay rent, Landing Fees, or to make any other payment required hereunder, when due to City, and such failure shall continue beyond the date specified in a written notice of such breach or default from Director, which date shall be no earlier than the tenth (10th) day after the effective date of such notice. Notwithstanding the foregoing, in the event there occurs two (2) defaults in the payment of rent, Landing Fees, or other payment under this Agreement, thereafter Airline shall not be entitled to, and City shall have no obligation to give, notice of any further defaults in the payment of rent, Landing Fees, or other payment. In such event, there shall be deemed to occur an "Event of Default" immediately upon Airline's failure to duly and punctually pay rent, Landing Fees or other payment hereunder; or

(ii) Airline shall become insolvent, or shall take the benefit of any present or future insolvency statute, or shall make a general assignment for the benefit of creditors, or file a voluntary petition in bankruptcy, or a petition or answer seeking an

arrangement for its reorganization, or the readjustment of its indebtedness under the federal bankruptcy laws, or under any other Applicable Law, or consent to the appointment of a receiver, trustee, or liquidator of any or substantially all of its property; or

(iii) A petition under any part of the federal bankruptcy laws, or an action under any present or future insolvency law or statute, shall be filed against Airline and shall not be dismissed within thirty (30) days after the filing thereof; or

(iv) There shall occur a Transfer (other than in accordance with Section 16.2(B) or (C)) without the prior approval of the City, and such Transfer shall not be voided or rescinded within ten (10) days after receipt of notice from City to Airline; or

(v) Airline shall abandon, desert, or vacate the Demised Premises; or

(vi) Any lien shall be filed against the Demised Premises as a result of an act or omission of Airline, and shall not be discharged or contested by Airline in good faith by proper legal proceedings within thirty (30) days after receipt of notice by Airline; or

(vii) Airline shall fail to provide the Deposit when required hereunder or shall fail to maintain in full such Deposit at all times thereafter, and such failure shall continue for a period of more than three (3) days after delivery by Director of written notice of such failure; or

(viii) Airline shall fail to obtain and maintain the insurance or self-insured reserves required hereunder, or provide copies of the policies or certificates to City as required herein; or

(ix) Airline shall fail to keep, perform and observe each and every other promise, covenant and agreement set forth in this Agreement, and such failure shall continue for a period of more than ten (10) days after delivery by Director of a written notice of such failure (the “**First Notice**”); or if satisfaction of such obligation requires activity over a period of time, if Airline fails to commence the cure of such failure within ten (10) days after receipt of the First Notice, or thereafter fails to diligently prosecute such cure, or fails to actually cause such cure within one hundred twenty (120) days after the giving of the First Notice;

(x) There shall occur a default under any other agreement between Airline and City, if any, and such default is not cured as may be provided in such agreement; provided, however, that nothing herein shall be deemed to imply that Airline shall be entitled to additional notice or cure rights at such default other than as may be provided in such other agreement; or

(xi) Airline shall fail duly and timely to remit to City any PFCs collected by Airline from its passengers in accordance with 49 U.S.C. § 40117 and

applicable implementing regulations adopted by the FAA, 14 CFR Pt. 158, as they may be amended from time to time.

**Section 17.2 Remedies.** Upon the occurrence and during the continuance of an Event of Default, City shall have the following rights and remedies in addition to all other rights and remedies available to City under this Agreement or any Applicable Law:

A. City shall have the rights and remedies provided by California Civil Code Section 1951.2 (damages on termination for breach), including the right to terminate Airline's right to use the Demised Premises upon written notice to Airline. Airline expressly acknowledges that in the absence of such written notice from City, no other act of City, including, but not limited to, its re-entry into the Demised Premises, its efforts to relet the Demised Premises, its reletting of the Demised Premises for Airline's account, its storage of Airline's personal property and trade fixtures, its acceptance of keys to the Demised Premises from Airline, its appointment of a receiver, or its exercise of any other rights and remedies under this Section or otherwise at law shall constitute an acceptance of Airline's surrender of the Demised Premises or constitute a termination of this Agreement or of Airline's right to possession of the Demised Premises.

B. Upon any termination in writing of Airline's right to possession of the Demised Premises, this Agreement shall terminate and City shall be entitled to recover damages from Airline as provided in California Civil Code Section 1951.2 or any other applicable existing or future laws providing for recovery of damages for such breach, including, but not limited to, the following:

- (i) The reasonable cost of recovering the Demised Premises; plus
- (ii) The reasonable cost of removing Airline's Alterations, trade fixtures and improvements; plus
- (iii) All unpaid rent due or earned hereunder prior to the date of termination, less the proceeds of any reletting or any rental received from subtenants prior to the date of termination applied as provided below, together with interest at the Interest Rate, on such sums from the date such rent is due and payable until the date of the award of damages; plus
- (iv) The amount by which the rent which would be payable by Airline hereunder, as reasonably estimated by City, from the date of termination until the date of the award of damages, exceeds the amount of such rental loss as Airline proves could have been reasonably avoided, together with the interest rate on such sums from the date such rent is due and payable until the date of the award of damages; plus
- (v) The amount by which the rent which would be payable by Airline hereunder, as reasonably estimated by City, for the remainder of the then Term after the date of the award of damages exceeds the amount such rental loss as Airline proves could have been reasonably avoided, discounted at the discount rate published by the Federal

Reserve bank of San Francisco for member banks at the time of the award plus one percent (1%); plus

(vi) Any other amount necessary to compensate City for all the detriment proximately caused by Airline's failure to perform its obligations under this Agreement or which in the ordinary course of things would be likely to result therefrom.

For purposes of the foregoing, the amounts referred to in clauses (iii) and (iv) above are computed by allowing interest at the lower of eighteen 18% per annum and the highest rate legally permitted under applicable law. For purposes of the foregoing, the term "rent" shall mean all rent, Landing Fees, and other amounts payable by Airline hereunder. Notwithstanding any other provisions hereof, any efforts by City to mitigate damages caused by Airline's breach of this Agreement shall not constitute a waiver of City's right to recover damages hereunder and shall not affect the right of City to indemnification pursuant to the provisions of Article 14. Airline agrees that Airline's obligations under this Agreement, including the payment of rent, are independent covenants and are not conditioned on the covenants or warranties of City.

C. City shall have the right and remedy described in California Civil Code Section 1951.4. City may elect not to terminate this Agreement and let this Agreement continue, in which case City may enforce all its rights and remedies under this Agreement, including the right to recover rent as it becomes due under this Agreement. Acts of maintenance or preservation or efforts to relet the Demised Premises or the appointment of a receiver upon the initiative of City to protect City's interest under this Agreement shall not constitute a termination of Airline's right to possession.

D. City shall have the right to have a receiver appointed upon application by City to take possession of the Demised Premises and to collect the rents or profits therefrom and to exercise all other rights and remedies pursuant to this Section.

E. City shall have the right to enjoin, and any other remedy or right now or hereafter available to a landlord against a defaulting tenant under the laws of the State or the equitable powers of its courts, and not otherwise specifically reserved herein.

F. City may elect to terminate any other agreement between Airline and City.

**Section 17.3** **City's Right to Perform.** All agreements and provisions to be performed by Airline under any of the terms of this Agreement shall be at its sole cost and expense and without any abatement of rent or Landing Fees. If Airline shall fail to make any payment or perform any act on its part to be performed hereunder and such failure shall continue for three (3) days (as to any emergency), or thirty (30) days (as to any non-emergency), after notice thereof by City, City may, but shall not be obligated to do so, and without waiving or releasing Airline from any obligations of Airline, make any such payment or perform any such other act on Airline's part to be made or performed as provided in this Agreement. All sums so paid by City and all necessary incidental costs shall be deemed additional rent hereunder and shall be payable to City on demand, and City shall have (in addition to any other right or remedy of City)

the same rights and remedies in the event of the nonpayment thereof by Airline as in the case of default by Airline in the payment of rent or Landing Fees.

**Section 17.4** Rights Related to Termination. In the event of any termination based on any breach of the covenants, terms and conditions contained in this Agreement, City shall have the option at once and without further notice to Airline to enter upon the Demised Premises and take exclusive possession of same. City may remove or store any personal property located therein, at the sole cost and expense of Airline without City being liable to Airline for damages or loss thereby sustained by Airline. Upon such termination by City, all rights, powers and privileges of Airline hereunder shall cease, and Airline shall immediately vacate any space occupied by it under this Agreement, and Airline shall have no claim of any kind whatsoever against City or any City Entity by reason of such termination, or by reason of any act by City or any City Entity incidental or related thereto. In the event of the exercise by City of such option to terminate, Airline shall have no right to or claim upon any improvements or the value thereof, which may have been previously installed by Airline in or on the Demised Premises.

**Section 17.5** Cumulative Rights. The exercise by City of any remedy provided in this Agreement shall be cumulative and shall in no way affect any other remedy available to City under this Agreement or Applicable Law.

**Section 17.6** Prepayment of Terminal Area Rentals/Landing Fees. Notwithstanding anything to the contrary herein, in the event Airline shall fail to pay any amount, including Terminal Area Rentals and Landing Fees when due hereunder (whether for itself or its Affiliate Airlines), and such failure to pay continues beyond any applicable notice and cure period, Director shall have the right to require Airline to pay estimated Terminal Area Rentals, Landing Fees, and all other amounts due hereunder in advance of the month during which the same shall accrue. For Landing Fees and other fees based on usage, prepayment shall be based on the highest previous fees charged to Airline in the previous 12 months. The Director may exercise such right by giving written notice to Airline at any time after such default and failure to cure by Airline, regardless of whether the same is cured by Airline. Such right shall be in addition to and not in lieu of any and all other rights hereunder, or at law or in equity.

**Section 17.7** Fines. City reserves the right to impose and collect from Airline the fines set forth in the Airport Rules as established and updated from time to time by the Director for violations of Airport Rules or the terms of this Agreement by any Airline Entity.

Director's right to impose fines pursuant to this Agreement shall be in addition to and not in lieu of any and all other rights hereunder, in the Airport Rules, at law or in equity. City shall have no obligation to Airline to impose fines on or otherwise take action against any other tenant at the Airport. THE PARTIES HAVE AGREED THAT THE VIOLATIONS SET FORTH IN THE AIRPORT RULES SHALL RESULT IN CITY INCURRING DAMAGES WHICH ARE IMPRACTICAL OR IMPOSSIBLE TO DETERMINE. THE PARTIES HAVE AGREED THAT THE FINES FOR SUCH VIOLATIONS SET FORTH IN THE AIRPORT RULES ARE A REASONABLE APPROXIMATION OF SUCH DAMAGES. Such fines shall constitute "additional rent."

City reserves the right to impose and collect from Airline reimbursement for any fines for violations of any federal, state, or local laws or regulations by any Airline Entity.

**Section 17.8** Termination for Cessation of Use. Without limiting the generality of Section 17.1 above, City shall have the right, but in no event any obligation, to terminate this Agreement if Airline ceases all Revenue Aircraft Arrivals at the Airport and such cessation continues for more than thirty (30) consecutive days. To exercise such right of termination, City shall give a termination notice to Airline. In such event, this Agreement shall terminate on the date specified in the notice. City shall not have the foregoing right to terminate for such cessation if such cessation is caused by a force majeure event described in Section 21.8.

**Section 17.9** Waiver of Notice. Except as otherwise expressly provided in this Article 17, Airline hereby expressly waives, so far as permitted by law, the service of any notice of intention to enter or re-enter provided for in any statute, or of the institution of legal proceedings to that end, and Airline, for and on behalf of itself and all persons claiming through or under Airline, also waives any right of redemption or relief from forfeiture under California Code of Civil Procedure Sections 1174 or 1179, or under any other present or future law, if Airline is evicted or City takes possession of the Demised Premises by reason of any default by Airline hereunder.

**Section 17.10** Annual Service Payments and City's Right to Suspend Part of Agreement.

A. An Annual Service Payment will be paid from the Airport Revenue Fund into the General Fund of the City for each Fiscal Year during the Term of this Agreement beginning with Fiscal Year 2023/2024. In each such Fiscal Year, the Annual Service Payment shall equal the greater of (a) fifteen percent (15%) of Concession Revenues or (b) five million dollars (\$5,000,000).

In each Fiscal Year, payment of the Annual Service Payment from the Airport Revenue Fund to the City's General Fund shall be made in installments on September 30, December 31, March 31 and June 30. Each of the installments payable on these dates shall be in an amount equal to twenty-five percent (25%) of the budgeted Annual Service Payment for such Fiscal Year. As part of each Fiscal Year audit, the Annual Service Payment shall be recalculated based on actual Concession Revenues and the payment submitted to the City shall be adjusted to reflect the recalculation.

During the Term of this Agreement, the Commission will not make any payments to the City's General Fund other than the Annual Service Payments, to reimburse the City for the costs of any and all indirect services provided by the City to the Commission during any Fiscal Year in which Annual Service Payments calculated as provided above are paid. The Commission shall not make any additional payments to the City's General Fund for indirect services provided by the City to the Airport during any such Fiscal Year. The Commission may, in addition to making Annual Service Payments, continue to reimburse the City's General Fund for the actual, verifiable, and reasonable costs of direct services provided by the City to the Airport.

B. Reserved.

C. In the event that the Annual Service Payment provided for above cannot be made for any reason, other than Airport's own inaction or action not in conformance with this Agreement, including, but not limited to, supervening legislation or court decision, City may elect to suspend uniformly as to all Signatory Airlines all or some of the following provisions of this Agreement:

Article	Section	
4	4.3	Landing Fees
5	5.3(A)-(K)	Method of Adjusting Landing Fees
5	5.4(A)	Review of Adjusted Rentals and Fees (only to the extent it pertains to adjustment of Landing Fees "in accordance with this Agreement")
6	6.1(B)	Capital Improvements
6	6.2(A)	Review of Capital Improvements
6	6.2(C)	Review of Capital Improvements
8	8.3	Airfield Area Users
19	19.1	Holding Over

In addition or alternatively, in such event City may: (1) appropriate an amount equal to the Annual Service Payment then payable hereunder in any Fiscal Year for Capital Improvements included in City's then-current capital improvement program pursuant to Sections 16.104(b)(5) and (6) of the City Charter (or any successor legislation) and any such appropriation shall not be subject to Section 6.2; and (2) during any period of suspension of Sections 4.3, and 5.3(A) through (K), pursuant to this Section, adjust the level of Terminal Area Rental Rates, observing in the calculations of such adjusted rental rates the Cost Centers and procedures for allocation of revenues, expenses, and Debt Service to such Cost Centers as illustrated in Exhibit O, and maintaining the relationships between rental rates for each Space Category of Demised Premises; provided, however, Airline reserves its rights to contest such adjusted rental rates through legal processes to determine whether any such adjusted rental rates are reasonable or are otherwise in accordance with applicable law.

D. The right of City to elect to suspend the above-referenced provisions, or any of them, shall not be effective unless and until:

- (i) The payment of the Annual Service Payment is interrupted for any cause other than City's own inaction or action not in conformance with this Agreement;
- (ii) City has given written notice to Airline of such interruptions in payment;

(iii) Within twelve (12) months after the date of the notice of interruption in payment, the City has failed to achieve the resumption of such Annual Service Payment or to have received sums equal to the then-current Annual Service Payment obligation for its General Fund in lieu thereof; and

(iv) After expiration of such twelve (12) month period, City shall have given Airline thirty (30) days written notice of its election to exercise such right to suspend, which notice shall specify which of the above-referenced provisions of this Agreement are suspended. Following receipt of such notice and until Section 17.10(F)(iv) shall be applicable, Airline may elect to terminate this Agreement upon thirty (30) days written notice to City.

E. During the period commencing with any such interruption of Annual Service Payments and continuing thereafter until such payments are resumed or sums equal to the then-current Annual Service Payment obligation are received by City's General Fund, in lieu thereof, Section 5.2(B) shall remain in effect, and amounts equal to the Annual Service Payment shall be segregated as accumulated in an identifiable, interest-bearing subaccount of the Airport Revenue Fund by City. Monies in such subaccount may be applied to any lawful purpose of the Commission; provided, however, that to the extent such monies are so applied the Annual Service Payment shall be deemed satisfied, pro tanto.

F. During any period of any interruptions of the Annual Service Payment to City, City shall use commercially reasonable efforts to achieve the resumption of such Annual Service Payment or receipt in the General Fund of a sum equivalent to the then-current Annual Service Payment obligation in lieu thereof. Upon resumption of the Annual Service Payment or receipt of sums equivalent to the then-current Annual Service Payment obligation by City's General Fund in lieu thereof:

(i) The right of Commission to suspend or continue suspension of the provisions referred to in this Section shall terminate;

(ii) Commission shall release from the Airport Revenue Fund subaccount all funds therein, plus accrued interest, to the Airport Revenue Fund to be available for customary budgeting disposition;

(iii) As soon as practicable thereafter, Commission shall make any necessary adjustments to the Terminal Area Rentals and Landing Fees; and

(iv) Airline's right to terminate this Agreement as provided in Section 17.10(D)(iv) shall terminate.

G. During any period of suspension of some or all of the above-referenced provisions pursuant to this Section, City may take such other actions as may be permitted by law which are designed to provide City with substitute monies in lieu of the Annual Service Payment provided for in Section 5.2(B); provided, however, Airline reserves its rights to challenge the reasonableness or contest the legality of any such actions and nothing in this Agreement shall operate as a waiver of, or estoppel or other bar to, any such challenge or contest.



H. No action properly taken by City in exercise of its rights under this Article 17 shall be deemed a breach of any other provision of this Agreement.

**Section 17.11** Airline's Right to Terminate. If Airline is not then in default in the payment of any amount due from it to City hereunder, Airline, in addition to any other rights given to it herein or to which it may be entitled by law, may terminate this Agreement in its entirety by giving City ninety (90) days advance written notice upon or after the occurrence and during the continuance of any one or more of the following events:

A. The issuance of a permanent injunction by any court of competent jurisdiction substantially restraining or preventing Airline from using all or major portions of the Airport for airport purposes and its remaining in force for one hundred and eighty (180) days;

B. Any action of any governmental authority, board, agency or officer having jurisdiction thereof preventing Airline from conducting its air transportation business in its entirety at the Airport;

C. The involuntary termination by any governmental authority, board, agency or officer having jurisdiction, of Airline's right to serve San Francisco, California; or

D. The default by City in the performance of any material covenant or agreement required to be performed by City herein, which default materially and adversely limits or prohibits Airline's operations at the Airport, and the failure by City to remedy such default after written notice thereof has been delivered to City, unless (i) City takes prompt action to remedy such default within a period of sixty (60) days after receipt from Airline of such notice, or (ii) in the case of any such failure which cannot with due diligence be cured within such sixty (60) day period, City takes corrective action within the sixty (60) day period and diligently pursues such action until the failure is cured.

## **ARTICLE 18. SURRENDER OF POSSESSION OF DEMISED PREMISES**

### **Section 18.1** Surrender.

A. At the Expiration Date (including the Expiration Date of any renewal or extension term), or upon any other partial or entire surrender of the Demised Premises, including, without limitation: (i) in connection with any termination for cessation of use, as provided in Section 17.8; (ii) if for any reason a Preferential Use Gate previously assigned to Airline is no longer assigned to Airline, or (iii) upon either an Involuntary Airline Relocation or Voluntary Airline Relocation as provided in Section 7.3 (such date being the "**Surrender Date**"), Airline shall peaceably quit and surrender to City the Demised Premises, together with the improvements and all Alterations approved by City in good order and condition, broom-clean, except for normal wear and tear after Airline having made the last necessary repair required on its part under this Agreement, and further except for any portion of the Demised Premises condemned and any damage and destruction for which Airline is not responsible hereunder. At the election of City, Airline's surrender of the Demised Premises hereunder may be conducted over a period of time determined by Airport (rather than on one Surrender Date) to satisfy operational or logistical considerations, provided that the last date of such period of time

when Airline has finally satisfied all of its surrender obligations hereunder shall be deemed the Surrender Date for purposes of this Agreement.

B. Immediately before the Surrender Date, Airline shall remove all personal property, equipment and trade fixtures, and repair any damage resulting from the removal; provided, City in its sole discretion shall have the right to reserve ownership of any telecommunications equipment, wire, cabling or conduit installed in the Demised Premises by or on behalf of Airline. If such removal is not completed at the expiration or other termination of this Agreement, City may remove the same at Airline's expense. In such event, Airport shall not be responsible for any losses related to such personal property, at City's option, be deemed abandoned and disposed of in accordance with Section 1980 et seq. of the California Civil Code or in any other manner allowed by law. Notwithstanding anything to the contrary in this Agreement, City may elect at any time prior to five (5) days after the Surrender Date, to require Airline to remove, at Airline's sole expense (except in connection with an Involuntary Airline Relocation, in which the expenses shall be allocated as set forth in Section 7.3), all or part of the improvements, Alterations, trade fixtures or equipment constructed or installed by or at the expense of Airline including, but not limited to, any passenger loading bridges, baggage handling systems, telecommunications equipment, wires, cabling and/or conduit installed in the Demised Premises by or on behalf of Airline. Airline shall promptly remove such items and shall repair, at no cost to the City (except in connection with an Involuntary Airline Relocation, in which the expenses shall be allocated as set forth in Section 7.3), any damage to the Demised Premises resulting from such removal, or if Airline fails to repair, City may do so, at Airline's expense. Airline's obligations under this Section shall survive the Expiration Date or other termination of this Agreement.

## **ARTICLE 19. HOLDING OVER**

**Section 19.1** Month to Month. If Airline shall, with the concurrence of Director, hold over after the Expiration Date, the resulting tenancy shall, unless otherwise mutually agreed, be on a month-to-month basis, and may be terminated by Airline or City at any time on thirty (30) days written notice to the other party. During such month-to-month tenancy, Airline shall pay to City the same rate of rentals and Landing Fees as are set forth herein, unless different rates shall be agreed upon, and the parties shall be bound by all of the provisions of this Agreement, insofar as they may be pertinent, unless different terms and conditions shall be agreed upon. If Airline shall, without the prior written consent of Director, hold over after the Expiration Date, Airline shall pay to City on a month-to-month basis the rentals and the Non-Signatory Premium on Landing Fees as provided in Section 5.3(J) for any such holdover period and shall otherwise be subject to the terms and conditions of this Agreement beyond the end of the term hereof. Any holding over without Director's prior written consent shall constitute a default by Airline and entitle City to exercise any or all remedies as provided herein, notwithstanding that City may elect to accept one or more payments of Terminal Area Rentals, and whether or not such amounts are at the holdover rate specified above or the rate at the Expiration Date.

## ARTICLE 20. CITY CONTRACTING PROVISIONS

**Section 20.1** Nondiscrimination Ordinance. Airline shall comply with the following:

A. Airline Shall Not Discriminate. In the performance of this Agreement, Airline agrees not to discriminate against any employee, City employee working with Airline, applicant for employment with Airline, or against any person seeking accommodations, advantages, facilities, privileges, services, or membership in all business, social, or other establishments or organizations, on the basis of the fact or perception of a person's race, color, creed, religion, national origin, ancestry, age, height, weight, sex, sexual orientation, gender identity, domestic partner status, marital status, disability or Acquired Immune Deficiency Syndrome or HIV status (AIDS/HIV status), or association with members of such protected classes, or in retaliation for opposition to discrimination against such classes.

B. Subleases and Other Subcontracts. Airline shall include in all subleases and other subcontracts relating to the Demised Premises a non-discrimination clause applicable to such subtenant or other subcontractor in substantially the form of Subsection (A) above. In addition, Airline shall incorporate by reference in all subleases and other subcontracts the provisions of Sections 12B.2(a), 12B.2(c)-(k), and 12C.3 of the San Francisco Administrative Code and shall require all subtenants and other subcontractors to comply with such provisions. Tenant's failure to comply with the obligations in this Subsection shall constitute a material breach of this Agreement.

C. Non-Discrimination in Benefits. Airline does not as of the date of this Agreement and will not during the Term, in any of its operations in San Francisco on real property owned by City, or where work is being performed for City elsewhere in the United States, discriminate in the provision of bereavement leave, family medical leave, health benefits, membership or membership discounts, moving expenses, pension and retirement benefits or travel benefits, as well as any benefits other than the benefits specified above, between employees with domestic partners and employees with spouses, and/or between the domestic partners and spouses of such employees, where the domestic partnership has been registered with a governmental entity pursuant to state or local law authorizing such registration, subject to the conditions set forth in Section 12B.2(b) of the San Francisco Administrative Code.

D. Conditions to Contract. As a condition to this Agreement, in the event that Airline is now or at any time during the Term leasing Exclusive Use Space under this Agreement, Airline shall execute the "Chapter 12B Declaration: Nondiscrimination in Contracts and Benefits" form [(Form HRC-12B-101)] with supporting documentation and secure the approval of the form by the San Francisco Human Rights Commission. Airline hereby represents, covenants and agrees that prior to leasing and taking possession of any such Exclusive Use Space, now or at any time during the Term, (i) Airline has or will have executed and submitted to the HRC Form HRC-12B-101 with supporting documentation, and (ii) the HRC has or will have approved such form.

E. Incorporation of Administrative Code Provisions by Reference. The provisions of Chapters 12B and 12C of the San Francisco Administrative Code relating to non-discrimination by parties contracting for the lease of City property are incorporated in this

Section by reference and made a part of this Agreement as though fully set forth herein. Airline shall comply fully with and be bound by all of the provisions that apply to this Agreement under such Chapters of the Administrative Code, including, but not limited to, the remedies provided in such Chapters. Without limiting the foregoing, Airline understands that pursuant to Sections 12B.2(h), 12C.3(g) of the San Francisco Administrative Code, a penalty of fifty dollars (\$50) for each person for each calendar day during which such person was discriminated against in violation of the provisions of this Agreement may be assessed against Airline and/or deducted from any payments due Airline.

**Section 20.2** Conflict of Interest. Through its execution of this Agreement, Airline acknowledges that it is familiar with the provision of Section 15.103 of the City's Charter, Article III, Chapter 2 of City's Campaign and Governmental Conduct Code, and Section 87100 et seq. and Section 1090 et seq. of the Government Code of the State, and certifies that it does not know of any facts which constitutes a violation of said provisions and agrees that it will immediately notify the City if it becomes aware of any such fact during the term of this Agreement.

**Section 20.3** Tropical Hardwoods and Virgin Redwoods. The City urges companies not to import, purchase, obtain or use for any purpose any tropical hardwood, tropical hardwood wood product, virgin redwood or virgin redwood wood product. Except as expressly permitted by the application of Sections 802(B) and 803(B) of the San Francisco Environment Code, Airline shall not provide any items to the construction of Airline tenant improvements or the Alterations, or otherwise in the performance of this Agreement, which are tropical hardwoods, tropical hardwood wood products, virgin redwood, or virgin redwood wood products. In the event Airline fails to comply in good faith with any of the provisions of Chapter 8 of the San Francisco Environment Code, Airline shall be liable for liquidated damages for each violation in any amount equal to Airline's net profit on the contract, or five percent (5%) of the total amount of the contract dollars, whichever is greater.

**Section 20.4** Drug-Free Workplace Policy. Airline acknowledges that pursuant to the Federal Drug-Free Workplace Act of 1989, the unlawful manufacture, distribution, dispensation, possession or use of a controlled substance is prohibited on City premises. Airline agrees that any violation of this prohibition by Airline, its employees, agents or assigns shall be deemed a material breach of this Agreement.

**Section 20.5** Compliance with Americans with Disabilities Act and Air Carrier Access Act. Airline acknowledges that, pursuant to the ADA and the ACAA, to the extent applicable to Airline, programs, services and other activities provided by a public entity to the public, whether directly or through a contractor, must be accessible to the disabled public. To the extent the ADA or the ACAA is so applicable: (a) Airline shall provide the services specified in this Agreement in a manner that complies with the ADA (including, without limitation, the obligation to assist disable passengers with boarding and deplaning where level entry loading bridges are not available) or the ACAA, as applicable, and any and all other applicable federal, State and local disability rights legislation; (b) Airline agrees not to discriminate against disabled persons in the provision of services, benefits or activities provided under this Agreement; and (c) Airline

further agrees that any violation of this prohibition on the part of Airline, its employees, agents or assigns shall constitute a material breach of this Agreement.

**Section 20.6 Pesticide Prohibition.** Chapter 3 of the San Francisco Environment Code (the Integrated Pest Management Program Ordinance or “**IPM Ordinance**”) describes an integrated pest management (“**IPM**”) policy to be implemented by all City departments. Airline may not use or apply or allow the use or application of any pesticides on the Demised Premises or contract with any party to provide pest abatement or control services to the Demised Premises without first receiving City’s written approval of an IPM plan that (i) lists, to the extent reasonably possible, the types and estimated quantities of pesticides that Airline may need to apply to the Demised Premises during the Term, (ii) describes the steps Airline will take to meet City’s IPM Policy described in Section 300 of the IPM Ordinance, and (iii) identifies, by name, title, address, and telephone number, an individual to act as the Airline’s primary IPM contact person with City. Airline will comply, and will require all of Airline’s contractors to comply, with the IPM plan approved by City and will comply with the requirements of Sections 300(d), 302, 304, 305(f), 305(g), and 306 of the IPM Ordinance, as if Airline were a City department. Among other matters, the provisions of the IPM Ordinance: (i) provide for the use of pesticides only as a last resort, (ii) prohibit the use or application of pesticides on City property, except for pesticides granted an exemption under Section 303 of the IPM Ordinance (including pesticides included on the most current Reduced Risk Pesticide List compiled by City’s Department of the Environment), (iii) impose certain notice requirements, and (iv) require Airline to keep certain records and to report to City all pesticide use at the Demised Premises by Airline’s staff or contractors. Nothing herein shall prevent Airline, through the Director, from seeking a determination from the Commission on the Environment that it is exempt from complying with certain portions of the IPM Ordinance as provided in Section 303 thereof.

**Section 20.7 MacBride Principles - Northern Ireland.** The City urges companies doing business in Northern Ireland to move toward resolving employment inequities and encourages them to abide by the MacBride Principles as expressed in San Francisco Administrative Code Section 12F.1 et seq. City also urges San Francisco companies to do business with corporations that abide by the MacBride Principles. Airline acknowledges that it has read and understands the above statement of the City concerning doing business in Northern Ireland.

**Section 20.8 General Advertising Restrictions; Tobacco Products; Alcoholic Beverages.**

A. Airline shall have no right to conduct any advertising or promotional activities on the Airport, including, for the avoidance of doubt, any Virtual Advertisements.

B. Airline acknowledges and agrees that no sales or advertising of cigarettes or tobacco products is allowed on the Demised Premises. This prohibition includes the placement of the name of a company producing, selling or distributing cigarettes or tobacco products or the name of any cigarette or tobacco product in any promotion of any event or product. This prohibition does not apply to any advertisement sponsored by a state, local or nonprofit entity designed to communicate the health hazards of cigarettes and tobacco products or to encourage people not to smoke or to stop smoking.

C. Airline acknowledges and agrees that no advertising of alcoholic beverages is allowed on the Demised Premises. For purposes of this section, “alcoholic beverage” shall be defined as set forth in California Business and Professions Code Section 23004, and shall not include cleaning solutions, medical supplies and other products and substances not intended for drinking. This advertising prohibition includes the placement of the name of a company producing, selling or distributing alcoholic beverages or the name of any alcoholic beverage in any promotion of any event or product. This advertising prohibition does not apply to any advertisement sponsored by a state, local, nonprofit or other entity designed to (i) communicate the health hazards of alcoholic beverages, (ii) encourage people not to drink alcohol or to stop drinking alcohol, or (iii) provide or publicize drug or alcohol treatment or rehabilitation services. The foregoing prohibition shall not apply to areas of the Demised Premises operated by Airline where the provision of food and alcoholic beverages is permitted under this Agreement (i.e., airline lounges).

**Section 20.9** First Source Hiring Ordinance. Airline shall comply with the San Francisco First Source Hiring Ordinance (Board of Supervisors Ordinance No. 264-98) in cooperation with the Airport Commission Office of Employment and Community Partnerships pursuant to the First Source Hiring Agreement entered into between the Airport Commission and the Airline concurrently herewith and incorporated herein by reference.

**Section 20.10** Local Hire. Any undefined, initially-capitalized term used in this Section shall have the meaning given to such term in San Francisco Administrative Code Section 23.62 (the “**Local Hiring Requirements**”). All Alterations under this Agreement are subject to the Local Hiring Requirements unless the cost for such work is (a) estimated to be less than \$750,000 per building permit or (b) meets any of the other exemptions in the Local Hiring Requirements for all Covered Projects. Airline agrees that it shall comply with the Local Hiring Requirements to the extent applicable. Before starting any Alteration, Airline shall contact City’s Office of Economic Workforce and Development (“**OEWD**”) to verify if the Local Hiring Requirements apply to the work (i.e., whether the work is a “Covered Project”). Airline shall include, and shall require its subtenants to include, a requirement to comply with the Local Hiring Requirements in any contract for a Covered Project with specific reference to San Francisco Administrative Code Section 23.62. Each such contract shall name the City and County of San Francisco as a third-party beneficiary for the limited purpose of enforcing the Local Hiring Requirements, including the right to file charges and seek penalties. Airline shall cooperate, and require its subtenants to cooperate, with City in any action or proceeding against a contractor or subcontractor that fails to comply with the Local Hiring Requirements when required. Airline’s failure to comply with its obligations under this Section shall constitute a material breach of this Agreement. A contractor’s or subcontractor’s failure to comply with this Section will enable City to seek the remedies specified in San Francisco Administrative Code Section 23.62 against the breaching party. So long as Airline requires compliance with this Section in the construction contract for the Covered Project and reasonably cooperates with the City in any enforcement action, then it shall not be in breach of this Agreement due to a Contractor’s or Subcontractor’s failure to comply or to meet the mandatory participation levels.

**Section 20.11** Sunshine Ordinance. In accordance with Section 67.24(e) of the San Francisco Administrative Code, contracts, contractors’ bids, leases, agreements, responses to

Requests for Solicitations, and all other records of communications between City and persons or firms seeking contracts will be open to inspection immediately after a contract has been awarded. Nothing in this provision requires the disclosure of a private person's or organization's net worth or other proprietary financial data submitted for qualification for a contract, lease, agreement or other benefit until and unless that person or organization is awarded the contract, lease, agreement or benefit. Information provided which is covered by this Section will be made available to the public upon request.

**Section 20.12** Charter Provisions. This Agreement is governed by and subject to the provisions of the City Charter.

**Section 20.13** Requiring Health Benefits for Covered Employees.

A. Unless exempt, Airline agrees to comply fully with and be bound by all of the provisions of the Health Care Accountability Ordinance (HCAO), as set forth in San Francisco Administrative Code Chapter 12Q, including the remedies provided, and implementing regulations, as the same may be amended from time to time. The provisions of Chapter 12Q are incorporated herein by reference and made a part of this Agreement as though fully set forth. The text of the HCAO is available on the web at <http://www.sfgov.org/olse>. Capitalized terms used in this Section and not defined in this Agreement shall have the meanings assigned to such terms in Chapter 12Q.

B. For each Covered Employee, Airline shall provide the appropriate health benefit set forth in Section 12Q.3 of the HCAO. If Airline chooses to offer the health plan option, such health plan shall meet the minimum standards set forth by the San Francisco Health Commission.

C. Notwithstanding the above, if the Airline is a small business as defined in Section 12Q.3(d) of the HCAO, it shall have no obligation to comply with Subsection (A) above.

D. Airline's failure to comply with the HCAO shall constitute a material breach of this Agreement. City shall notify Airline if such a breach has occurred. If, within thirty (30) days after receiving City's written notice of a breach of this Agreement for violating the HCAO, Airline fails to cure such breach or, if such breach cannot reasonably be cured within such period of thirty (30) days, Airline fails to commence efforts to cure within such period, or thereafter fails diligently to pursue such cure to completion, City shall have the right to pursue the remedies set forth in Sections 12Q.5.1, 12Q.5(f)(1-6). Each of these remedies shall be exercisable individually or in combination with any other rights or remedies available to City.

E. Any Subcontract entered into by Airline shall require the Subcontractor to comply with the requirements of the HCAO and shall contain contractual obligations substantially the same as those set forth in this Section. Airline shall notify City's Purchasing Department when it enters into such a Subcontract and shall certify to the Purchasing Department that it has notified the Subcontractor of the obligations under the HCAO and has imposed the requirements of the HCAO on Subcontractor through the Subcontract. Airline shall be responsible for its Subcontractors' compliance with this Chapter. If a Subcontractor fails to comply, the City may pursue the remedies set forth in this Section against Airline based on the

Subcontractor's failure to comply, provided that City has first provided Airline with notice and an opportunity to obtain a cure of the violation.

F. Airline shall not discharge, reduce in compensation, or otherwise discriminate against any employee for notifying City with regard to Airline's compliance or anticipated compliance with the requirements of the HCAO, for opposing any practice proscribed by the HCAO, for participating in proceedings related to the HCAO, or for seeking to assert or enforce any rights under the HCAO by any lawful means.

G. Airline represents and warrants that it is not an entity that was set up, or is being used, for the purpose of evading the intent of the HCAO.

H. Airline shall maintain employee and payroll records in compliance with California Labor Code and Industrial Welfare Commission orders.

I. Airline shall keep itself informed of the current requirements of the HCAO.

J. Airline shall provide reports to the City in accordance with any reporting standards promulgated by the City under the HCAO, including reports on Subcontractors and Subtenants, as applicable.

K. Airline shall provide City with access to records pertaining to compliance with HCAO after receiving a written request from City to do so and being provided at least ten (10) business days to respond.

L. Airline shall allow City to inspect Airline's Demised Premises and to have access to Airline's employees in order to monitor and determine compliance with HCAO.

M. City may conduct random audits of Airline to ascertain its compliance with HCAO. Airline agrees to cooperate with City when it conducts such audits.

N. If Airline is exempt from the HCAO when this Agreement is executed because its amount is less than twenty-five thousand dollars (\$25,000), but Airline later enters into an agreement or agreements that cause Airline's aggregate amount of all agreements with City to reach seventy-five thousand dollars (\$75,000), all the agreements shall be thereafter subject to the HCAO. This obligation arises on the effective date of the agreement that causes the cumulative amount of agreements between Airline and the Contracting Department to be equal to or greater than seventy-five thousand dollars (\$75,000) in the Fiscal Year.

**Section 20.14** Requiring Minimum Compensation for Covered Employees.

A. Airline agrees to comply fully with and be bound by all of the provisions of the Minimum Compensation Ordinance (MCO), as set forth in San Francisco Administrative Code Chapter 12P (Chapter 12P), including the remedies provided, and implementing guidelines and rules. The provisions of Chapter 12P are incorporated herein by reference and made a part of this Agreement as though fully set forth. The text of the MCO is available on the web at



www.sfgov.org/olse/mco. A partial listing of some of Airline's obligations under the MCO is set forth in this Section. Airline is required to comply with all the provisions of the MCO, irrespective of the listing of obligations in this Section.

B. The MCO requires Airline to pay Airline's employees a minimum hourly gross compensation wage rate and to provide minimum compensated and uncompensated time off. The minimum wage rate may change from year to year and Airline is obligated to keep informed of the then-current requirements. Any sublease entered into by Airline shall require the subtenant to comply with the requirements of the MCO and shall contain contractual obligations substantially the same as those set forth in this Section. It is Airline's obligation to ensure that any subtenants of any tier under this Agreement comply with the requirements of the MCO. If any subtenant under this Agreement fails to comply, City may pursue any of the remedies set forth in this Section against Airline.

C. Airline shall not take adverse action or otherwise discriminate against an employee or other person for the exercise or attempted exercise of rights under the MCO. Such actions, if taken within ninety (90) days of the exercise or attempted exercise of such rights, will be rebuttably presumed to be retaliation prohibited by the MCO.

D. Airline shall maintain employee and payroll records as required by the MCO. If Airline fails to do so, it shall be presumed that the Airline paid no more than the minimum wage required under State law.

E. The City is authorized to inspect Airline's job sites and conduct interviews with employees and conduct audits of Airline.

F. Airline's commitment to provide the Minimum Compensation is a material element of the City's consideration for this Agreement. The City in its sole discretion shall determine whether such a breach has occurred. The City and the public will suffer actual damage that will be impractical or extremely difficult to determine if the Airline fails to comply with these requirements. Airline agrees that the sums set forth in Section 12P.6.1 of the MCO as liquidated damages are not a penalty but are reasonable estimates of the loss that the City and the public will incur for Airline's noncompliance. The procedures governing the assessment of liquidated damages shall be those set forth in Section 12P.6.2 of Chapter 12P.

G. Airline understands and agrees that if it fails to comply with the requirements of the MCO, the City shall have the right to pursue any rights or remedies available under Chapter 12P (including liquidated damages), under the terms of the contract, and under applicable law. If, within 30 days after receiving written notice of a breach of this Agreement for violating the MCO, Airline fails to cure such breach or, if such breach cannot reasonably be cured within such period of 30 days, Airline fails to commence efforts to cure within such period, or thereafter fails diligently to pursue such cure to completion, the City shall have the right to pursue any rights or remedies available under applicable law, including those set forth in Section 12P.6(c) of Chapter 12P. Each of these remedies shall be exercisable individually or in combination with any other rights or remedies available to the City.

H. Airline represents and warrants that it is not an entity that was set up, or is being used, for the purpose of evading the intent of the MCO.

I. If Airline is exempt from the MCO when this Agreement is executed because the cumulative amount of agreements with this department for the Fiscal Year is less than \$25,000, but Airline later enters into an agreement or agreements that cause contractor to exceed that amount in a Fiscal Year, Airline shall thereafter be required to comply with the MCO under this Agreement. This obligation arises on the effective date of the agreement that causes the cumulative amount of agreements between Airline and Commission to exceed \$25,000 in the Fiscal Year.

**Section 20.15** Notification of Limitations on Contributions. By executing this Agreement, Airline acknowledges its obligations under Section 1.126 of the City's Campaign and Governmental Conduct Code, which prohibits any person who contracts with, or is seeking a contract with, any department of the City for the rendition of personal services, for the furnishing of any material, supplies or equipment, for the sale or lease of any land or building, for a grant, loan or loan guarantee, or for a development agreement, from making any campaign contribution to (i) a City elected official if the contract must be approved by that official, a board on which that official serves, or the board of a state agency on which an appointee of that official serves, (ii) a candidate for that City elective office, or (iii) a committee controlled by such elected official or a candidate for that office, at any time from the submission of a proposal for the contract until the later of either the termination of negotiations for such contract or twelve months after the date the City approves the contract. The prohibition on contributions applies to each prospective party to the contract; each member of Airline's board of directors; Airline's chairperson, chief executive officer, chief financial officer and chief operating officer; any person with an ownership interest of more than 10% in Airline; any subcontractor listed in the bid or contract; and any committee that is sponsored or controlled by Airline. Airline certifies that it has informed each such person of the limitation on contributions imposed by Section 1.126 by the time it submitted a proposal for the contract and has provided the names of the persons required to be informed to the City department with whom it is contracting.

**Section 20.16** Compliance with Laws. Airline shall keep itself fully informed of the City Charter, codes, ordinances and regulations of the City and of all State, and federal laws in any manner applicable to the performance of this Agreement and must at all times comply with such applicable local codes, ordinances, and regulations and all applicable laws as they may be amended from time to time.

**Section 20.17** Airport Intellectual Property. Pursuant to Resolution No. 01-0118, adopted by the Airport Commission on April 18, 2001, the Commission affirmed that it will not tolerate the unauthorized use of its intellectual property, including the SFO logo, CADD designs, and copyrighted publications. All proposers, bidders, contractors, tenants, permittees, and others doing business with or at the Airport (including subcontractors and subtenants) may not use the Airport intellectual property, or any intellectual property confusingly similar to the Airport intellectual property, without the Director's prior written consent. For the avoidance of doubt, all Airport intellectual property under such Commission resolution shall constitute Airport Proprietary Content for purposes of Section 24.2.

**Section 20.18** Food Service Waste Reduction. If and to the extent applicable, the Airline agrees to comply fully with and be bound by all of the applicable provisions of the Food Service Waste Reduction Ordinance, as set forth in the San Francisco Environment Code, Chapter 16, including the remedies provided therein, and implementing guidelines and rules. The provisions of Chapter 16 are incorporated herein by reference and made a part of this Agreement as though fully set forth herein. Accordingly, Airline acknowledges that City contractors and lessees may not use Disposable Food Service Ware that contains Polystyrene Foam in City Facilities and while performing under a City contract or lease and shall instead use suitable Biodegradable/Compostable or Recyclable Disposable Food Service Ware. This provision is a material term of this Agreement. By entering into this agreement, Airline agrees that if it breaches this provision, City will suffer actual damages that will be impractical or extremely difficult to determine; further, Airline agrees that the sum of one hundred dollars (\$100.00) liquidated damages for the first breach, two hundred dollars (\$200.00) liquidated damages for the second breach in the same year, and five hundred dollars (\$500.00) liquidated damages for subsequent breaches in the same year is a reasonable estimate of the damage that City will incur based on the violation, established in light of the circumstances existing at the time this agreement was made. Such amounts shall not be considered a penalty, but rather agreed monetary damages sustained by City because of Airline's failure to comply with this provision.

**Section 20.19** Labor Disputes. Airline agrees to use commercially reasonable efforts to avoid disruption to City, other Air Carriers, Airport tenants, or members of the public arising from labor disputes involving Airline, and in the event of a strike, picketing, demonstration or other labor difficulty involving Airline, to use commercially reasonable efforts, including the utilization of available legal remedies, to minimize or eliminate any disruption to City, other Air Carriers, Airport tenants, or members of the public, arising from such strike, picketing, demonstration or other labor difficulty.

**Section 20.20** Preservative-Treated Wood Containing Arsenic. As of July 1, 2003, Airline may not purchase preservative-treated wood products containing arsenic in the performance of this Agreement unless an exemption from the requirements of Environment Code Chapter 13 is obtained from the Department of Environment under Section 1304 of the Environment Code. The term "preservative-treated wood containing arsenic" shall mean wood treated with a preservative that contains arsenic, elemental arsenic, or an arsenic copper combination, including, but not limited to, chromated copper arsenate preservative, ammoniac copper zinc arsenate preservative, or ammoniacal copper arsenate preservative. Airline may purchase preservative-treated wood products on the list of environmentally preferable alternatives prepared and adopted by the Department of Environment. This provision does not preclude Airline from purchasing preservative-treated wood containing arsenic for saltwater immersion. The term "saltwater immersion" shall mean a pressure-treated wood that is used for construction purposes or facilities that are partially or totally immersed in saltwater.

**Section 20.21** Vending Machines; Nutritional Standards and Calorie Labeling Requirements. Airline may not install or permit any vending machine on the Demised Premises without the prior written consent of the Director. Any permitted vending machine will comply with applicable food and beverage nutritional standards and calorie labeling requirements set forth in San Francisco Administrative Code Section 4.9-1(c), as may be amended from time to

time (the “**Nutritional Standards Requirements**”). Airline will incorporate the Nutritional Standards Requirements into any contract for the installation of a vending machine on the Demised Premises or for the supply of food and beverages to that vending machine. Failure to comply with the Nutritional Standards Requirements or to otherwise comply with this Section 20.21 will be a material breach of this Agreement. Without limiting City’s other rights and remedies under this Agreement, City will have the right to require the immediate removal of any vending machine on the Demised Premises that is not permitted or that violates the Nutritional Standards Requirements.

**Section 20.22** Reserved.

**Section 20.23** Resource-Efficient City Buildings. Airline acknowledges that City has enacted San Francisco Environment Code Chapter 7 relating to green building requirements. Airline hereby agrees that it shall comply with all provisions of such code applicable to construction work performed by or on behalf of Airline in the Demised Premises, including but not limited to LEED certification.

**Section 20.24** All-Gender Toilet Facilities. If applicable, Airline will comply with San Francisco Administrative Code Section 4.1-3 requiring at least one all-gender toilet facility on each floor of the Demised Premises in any building where extensive renovations are made by Airline. An “all-gender toilet facility” means a toilet that is not restricted to use by persons of a specific sex or gender identity by means of signage, design, or the installation of fixtures, and “extensive renovations” means any renovation where the construction cost exceeds 50% of the cost of providing the toilet facilities required by Administrative Code Section 4.1-3. If Airline has any question about applicability or compliance, Airline should contact BICE for guidance.

**Section 20.25** Reservation of Rights. On November 20, 2020, by Ordinance No. 235-20, the City enacted certain amendments to the HCAO set forth in San Francisco Administrative Code Chapter 12Q, known as the “Healthy Airport Ordinance” (as amended, the “**HAO**”). Neither the execution of this Agreement by Airline or City, nor the performance by either party under this Agreement, shall in any way prejudice or constitute a waiver of: (a) Airline’s right to challenge the HAO or the validity or enforcement thereof, or (b) the rights of either party to fully prosecute or defend, as applicable, any lawsuit by the Airline against the City challenging the HAO, including the validity and enforceability thereof. Each party reserves any and all rights it may have with respect to the HAO

## **ARTICLE 21. MISCELLANEOUS PROVISIONS**

**Section 21.1** No Individual Liability. No Commissioner, director, officer, agent or employee of either party shall be charged personally or held contractually liable by or to the other party under any term or provision of this Agreement or because of any breach thereof or because of its or their execution or attempted execution.

**Section 21.2** Agreements with Governments. This Agreement is subject and subordinate to the terms and conditions of any existing or future agreement entered into between the City and the United States of America for the improvement or operation and maintenance of the Airport, the execution of which has been or may be required as a condition precedent to the

transfer of federal rights or property to City for Airport purposes, or the expenditure of federal funds for the improvements or development of Airport; this Agreement will be subject to any ordinances, rules or regulations which have been, or may hereafter be adopted pertaining to Airport. Airline shall reasonably abide by the requirements of agreements entered into between City and the United States and shall consent to amendments and modifications of this Agreement if required by such agreements or if required as a condition of the City's entry into such agreements.

**Section 21.3** Governing Law; Venue. This Agreement shall be deemed to have been made in, and be construed in accordance with, the laws of the State and the City Charter. Venue for all litigation relative to the formation, interpretation and performance of this Agreement shall be in San Francisco, California.

**Section 21.4** Notices. Any notice given under this Agreement shall be effective only if in writing and given by delivering the notice in person or by sending it first-class mail or certified mail with a return receipt requested or by overnight courier, return receipt requested, with postage prepaid, to: (a) Airline, (i) at Airline's address set forth in the Airline's Address Notice, or (ii) at any place where Airline or any agent of Airline may be found if sent subsequent to Airline's vacating, abandoning or surrendering the Demised Premises; or (b) City, at City's address set forth in the City's Notice Address; or (c) to such other address as either City or Airline may designate as its new address for such purpose by notice given to the other in accordance with the provisions of this Section, and shall provide notice of any such changes no later than ten (10) days prior to the effective date of such change. Any notice hereunder shall be deemed to have been given two (2) days after the date when it is mailed if sent by first class or certified mail, one day after the date it is made if sent by overnight courier, or upon the date personal delivery is made. For convenience of the parties, copies of notices may also be given by email to the address set forth in the City's Notice Address and the Airline's Notice Address or such other email address as may be provided from time to time; however, neither party may give official or binding notice solely by email. Airline shall promptly provide City with copies of any and all notices received regarding any alleged violation of laws or insurance requirements or any alleged unsafe condition or practice related to Airline's use of, or its operations at, the Airport. Any provision herein that one party shall notify the other of some matter is to be construed as a requirement that notice is to be given in accordance with the provisions of this Section.

**Section 21.5** No Implied Waiver. No failure by City to insist upon the strict performance of any obligation of Airline under this Agreement or to exercise any right, power or remedy arising out of a breach thereof, irrespective of the length of time for which such failure continues, prior to the expiration of the Term by any City, shall constitute a waiver of such breach or of City's right to demand strict compliance with such term, covenant or condition or operate as a surrender of this Agreement. No express written waiver of any default or the performance of any provision hereof shall affect any other default or performance, or cover any other period of time, other than the default, performance or period of time specified in such express waiver. One or more written waivers of a default or the performance of any provision hereof shall not be deemed to be a waiver of a subsequent default or performance. Any consent by City hereunder shall not relieve Airline of any obligation to secure the consent of City in any other or future instance under the terms of this Agreement.

**Section 21.6** Federal Grant Agreement Covenants. Airline acknowledges that City is subject to Federal Grant Agreement obligations as a condition precedent to granting of funds for improvement of the Airport, and, accordingly, agrees to be bound by the following covenants provided by the FAA, as they may apply to Airline.

A. Airline for himself/herself, his/her heirs, personal representatives, successors in interest, and assigns, as part of the consideration hereof, does hereby covenant and agree as a covenant running with the land that in the event facilities are constructed, maintained, or otherwise operated on the property described in this Agreement for a purpose for which a U.S. Department of Transportation activity, facility, or program is extended or for another purpose involving the provision of similar services or benefits, Airline will maintain and operate such facilities and services in compliance with all requirements imposed by Title VI of the Civil Rights Act of 1964 (42 U.S.C. §2000d et seq., 78 stat. 252); 49 C.F.R. Part 21; and 28 C.F.R. section 50.3 (collectively, as they may be amended, the “**Acts and Regulations**”) such that no person on the ground of race, color or national origin, will be excluded from participation in, denied the benefits of, or be otherwise subjected to discrimination in the use of said facilities.

B. Airline for himself/herself, his/her heirs, personal representatives, successors in interest, and assigns, as part of the consideration hereof, does hereby covenant and agree as a covenant running with the land that (1) no person on the ground of race, color, or national origin, will be excluded from participation in, denied the benefits of, or be otherwise subjected to discrimination in the use of said facilities, (2) that in the construction of any improvements on, over, or under such land, and the furnishings of services thereon, no person on the ground of race, color or national origin, will be excluded from participation in, denied the benefits of, or otherwise be subjected to discrimination, (3) that Airline will use the premises in compliance with all other requirements imposed by or pursuant to the Acts and Regulations, as amended, set forth in this Assurance.

C. With respect to this Agreement, in the event of breach of any of the non-discrimination covenants, City will have the right to terminate this Agreement and to enter, re-enter, and repossess said lands and facilities thereon, and hold the same as if this Agreement had never been made or issued. This provision shall not become effective until the procedures of 49 CFR Part 21 are followed and completed including expiration of appeal rights.

D. Airline shall furnish its accommodations and/or services on a fair, equal and not unjustly discriminatory basis to all users thereof and it shall charge fair, reasonable and not unjustly discriminatory prices for each unit or service; provided, that Airline may be allowed to make reasonable and nondiscriminatory discounts, rebates or other similar types of price reductions to volume purchasers.

E. Non-compliance with Subsection (D) above shall constitute a material breach of this Agreement and in the event of such non-compliance City shall have the right to terminate this Agreement and any estate hereby created without liability therefor or, at the election of City or the United States, either or both said governments shall have the right to judicially enforce Subsections (A), (B), (C), and (D) of this Section.

F. Airline agrees that it shall insert or incorporate by reference the provisions in Subsections (A)-(E) of this Section in any agreement by which Airline grants a right or privilege to any person, firm or corporation to render accommodations and/or services to the public at the Airport.

G. Airline assures that it will comply with pertinent statutes, executive orders and such rules as are promulgated to assure that no person shall, on the grounds of race, creed, color, national origin, sex, age, or handicap, be excluded from participating in any activity conducted with or benefiting from federal assistance. This paragraph obligates Airline or its transferee for the period during which federal assistance is extended to the airport program, except where federal assistance is to provide, or is in the form of, personal property or real property or interests therein or structures or improvements thereon. In these cases, this paragraph obligates the party or any transferee for the longer of the following periods: (i) the period during which the property is used by the sponsor or any transferee for a purpose for which federal assistance is extended, or for another purpose involving the provision of similar services or benefits; or (ii) the period during which the airport sponsor or any transferee retains ownership or possession of the property. In the case of contractors, this paragraph binds the contractors from the bid solicitation period through the completion of the contract.

H. Notwithstanding anything set forth herein to the contrary, to the extent required: (a) under the Master Bond Documents; or (b) by the FAA, the DOT, the TSA or a similar governmental authority, other than City, having jurisdiction over the Airport, City reserves the right to further develop or improve the landing area of the Airport as required, regardless of the desires or views of Airline and without interference or hindrance.

I. This Agreement shall be subordinate to the provisions and requirements of any existing or future agreement between City and the United States relative to the development, operation or maintenance of the Airport.

J. Airline agrees to comply with the notification and review requirements covered in Part 77 of the Federal Aviation Regulations in the event any future structure or building is planned for the Airport premises or in the event of any planned modification or alteration of any present or future building or structure situated on the permitted premises.

K. Airline, by accepting this Agreement, agrees for itself and its successors and assigns that it will not make use of the Airport premises in any manner which might interfere with the landing and taking off of aircraft from the Airport or otherwise constitute a hazard. In the event the aforesaid covenant is breached, City reserves the right to enter upon the Airport premises and cause the abatement of such interference at the expense of Airline.

L. Airline, by accepting this Agreement, expressly agrees for itself and its successors and assigns that it will not erect nor permit the erection of any structure or object, nor permit the growth of any tree on the Airport premises, above the main sea level elevation that would exceed FAR Part 77 standards or elevations affecting the Airport navigable airspace. In the event the aforesaid covenants are breached, City reserves the right to enter upon the permitted premises and to remove the offending structure or object and cut the offending tree, all of which shall be at the expense of Airline.

M. All provisions of this Agreement shall be subordinate to the rights of the United States of America to operate the Airport or any part thereof during time of war or national emergency. Such rights shall supersede any provisions of this Agreement inconsistent with the operations of the Airport by the United States of America.

**Section 21.7 Contracting on More Favorable Terms.**

A. City covenants and agrees that in the event it enters into any lease, contract or any other agreement with any other Air Carrier containing more favorable terms than this Agreement, or grants to any Air Carrier rights, privileges, or concessions at the Airport which are not accorded Airline hereunder, it shall advise Airline of such action and this Agreement shall, at Airline's option, be amended to incorporate such rights, terms, privileges and concessions, or any of them, as part of this Agreement; provided, however, that this covenant shall not extend to any intrastate Air Carrier operating only aircraft of less than 30,000 pounds maximum gross weight nor shall it require City to permit international flights from any Domestic Terminal.

B. In the event that any Air Carrier shall undertake any operations at the Airport for the carriage of passengers, cargo or mail by air, City shall require, to the extent legally permissible, such Air Carrier to execute and deliver an agreement, lease, permit or contract with City providing for:

(i) the payment of Landing Fees at rates not less than those rates then in effect for the Signatory Airlines, and on such other terms and conditions that are not more favorable than those terms and conditions then in effect for the Signatory Airlines; and

(ii) the payment of (a) rentals, for any space leased from City in the Terminal Area at rates not less than those rates then payable by the Signatory Airlines for similar space; provided, however, that if space has been constructed by City for such Air Carrier and the rental rates then payable by the Signatory Airlines for similar space would not fairly compensate City for the cost of providing, maintaining, operating and administering such space over the term of its agreement with such Air Carrier, then at rental rates that will fairly compensate City; or (b) terminal operations charges, if such Air Carrier does not lease, sublease or hold space pursuant to a permit in the Terminal Area, which charge shall be payable for each aircraft arrival in the Terminal Area in an amount that will fairly compensate City; and

(iii) the payment of fees (including those described in Section 405) for use by such Air Carrier of Common Use and/or Joint Use areas, including operating costs of all baggage handling, public address, porter service or other passenger service systems, calculated and billed to such Air Carrier as in the case of the Signatory Airlines.

**Section 21.8 Force Majeure.** Neither City nor Airline shall be deemed in violation of this Agreement to the extent it is prevented from performing any of its obligations hereunder by reason of strikes, boycotts, labor disputes, embargoes, shortages of material, acts of terrorism, riots, rebellion, sabotage, epidemic or pandemic, or any other casualty which is not within its control; provided, however, that these provisions shall not excuse Airline from payment of the



Terminal Area Rentals and Landing Fees specified in Articles 4 and 5 hereinabove, the maintenance of the Deposit pursuant to Article 15, and other fees, rates, and charges specified in this Agreement.

**Section 21.9** Invalid Provisions and Severability. In the event any covenant, condition or provision herein contained is held to be invalid or unenforceable by a court of competent jurisdiction, the invalidity or unenforceability of any such covenant, condition or provision shall in no way affect any other covenant, condition or provision herein contained, provided the invalidity or unenforceability of any such covenant, condition or provision does not materially prejudice either City or Airline in their respective rights and obligations contained in the valid covenants, conditions and provisions of this Agreement.

**Section 21.10** Headings. The headings of the several Sections of this Agreement are inserted only as a matter of convenience and for reference and in no way define, limit or describe the scope or intent of any provisions of this Agreement, and shall not be construed to affect in any manner the term and provisions hereof or the interpretation or construction thereof.

**Section 21.11** Exclusiveness of Airline's Rights. Nothing herein contained shall be deemed to grant to Airline any exclusive right or privilege within the meaning of 49 U.S.C. Section 40103(e) or 49 U.S.C. Section 47107(a)(4) for activity on the Airport, except that, subject to the terms and provisions hereof, Airline shall have the right to exclusive possession of the Exclusive Use Space leased to Airline under the provisions of this Agreement.

**Section 21.12** Withholding Required Approvals. Whenever the approval of the Director, Commission, City or Airline is required herein, unless otherwise stated in this Agreement, no such approval shall be unreasonably refused, withheld or delayed.

**Section 21.13** Majority-in-Interest Decisions. Whenever decisions of a Majority-in-Interest are required hereunder, such decisions may be evidenced by a letter mailed pursuant to the provisions of Section 21.4 [Notices] from the then-current Chairman of the SFAAAC to Director.

**Section 21.14** Declaration Regarding Airport Private Roads. Airline hereby acknowledges and agrees that all roads existing at the date of execution hereof within the boundaries of the Airport, as shown on Exhibits A and B, attached hereto, are the private property and private roads of City, with the exception of that portion of the Old Bayshore Highway which runs through the southern limits of the City of South San Francisco and through the northern portion of the Airport to the intersection with the North Airport Road (also known as North Access Road), and with the exception of that portion of the North Airport Road which runs from the off- and on-ramps of the State Bayshore Freeway to the intersection with said Old Bayshore Highway (also known as South Airport Boulevard). It further acknowledges that any and all roads hereafter constructed or opened by City within the Airport boundaries will be the private property and roads of City, unless otherwise designated by appropriate action.

**Section 21.15** Subordination of Agreement.

A. Subject to the provisions of Section 17.10, this Agreement and all rights of Airline and City hereunder are expressly subject to the lien of any pledge, transfer, hypothecation, or assignment made at any time by City to secure Airport Revenue Bonds and to the terms and conditions of the Master Bond Documents. Airline acknowledges that any failure by Airline to make payments under this Agreement as and when such payments are due may result in a default by City on such Airport Revenue Bonds and related agreements.

B. With respect to property leased by City to Airline hereunder which was or is to be acquired by City with proceeds of Airport Revenue Bonds, the interest on which is, or is intended to be, excludable from the gross income of the holders of such Airport Revenue Bonds for federal income tax purposes, the parties hereby covenant not to take or fail to take any action that would impair the tax-exempt status of such Airport Revenue Bonds. In particular, Airline shall make an irrevocable election not to claim depreciation or an investment credit with respect to any property leased to Airline hereunder.

C. Airline agrees to execute all instruments, certificates, or other documents reasonably requested by City to assist City and bond counsel in determining and assuring that Airport Revenue Bonds are issued in compliance with applicable rules and regulations of the Internal Revenue Service and the Securities and Exchange Commission, and Airline shall provide whatever additional relevant information is reasonably requested by City initially or on an ongoing basis in connection with complying with any of those rules and regulations.

**Section 21.16** Inspection of Records. Airline and City, each at its own expense and upon reasonable notice, shall have the right to inspect the books, records and other data of the other party relating to the provisions and requirements hereof, provided such inspection is made during regular business hours. City agrees to provide Airline with a copy of the report of the annual audit covering the Airport.

**Section 21.17** Successors and Assigns. All of the terms, provisions, covenants, stipulations, conditions and considerations in this Agreement shall extend to and bind the legal representatives, successors, sublessees (except as to the rentals, fees and other charges with respect to sublessees only) and assigns of the respective parties hereto.

**Section 21.18** Taxes, Assessments and Liens.

A. Airline shall pay all taxes, assessments and charges of a like nature, if any (including any possessory interest tax), which at any time during the term of this Agreement may be levied against Airline or become a lien by virtue of any levy, assessment or charge against Airline by the federal government, the State, San Mateo County or any governmental successor in authority to the foregoing, or any other tax- or assessment-levying bodies, in whole or in part, upon or in respect to (a) the Demised Premises or such facilities of the Airport as are made available for use by Airline hereunder or (b) any personal property belonging to Airline situated on or in the Demised Premises. The property interest of Airline, if any, created by this Agreement may be subject to property taxation, and Airline may be subject to the payment of property tax levied on such interest. Payment of such additional charges for all such taxes,

assessments and charges, when and if levied or assessed, shall be made by Airline directly to the taxing or assessing authority charged with collection thereof, in which event Airline shall be responsible for obtaining bills for all of said taxes, assessments and charges and promptly providing City with evidence of payment therefor.

B. Airline may, at its expense, contest the amount or validity of any tax or assessment or the inclusion of the Demised Premises as taxable or assessable property directly against the taxing or assessing authority. Airline shall indemnify City from all taxes, penalties, costs, expenses, and attorneys' fees incurred by City resulting directly or indirectly from all such tax contests other than contests of City-imposed taxes.

C. Upon any termination of this Agreement, all lawful taxes then levied or a lien upon any of such property or taxable interest therein shall be paid in full by Airline forthwith or as soon as a statement thereof has been issued by the tax collector if termination occurs during the interval between the attachment of the lien and the issuance of the statement.

**Section 21.19** Appendices, Exhibits and Schedules. All exhibits referred to herein and all exhibits and schedules referred to in any appendices, and any appendices, exhibits or schedules which may, from time to time, be referred to in any duly executed amendment hereto are (and including future amendments, shall be) by such reference incorporated herein and shall be deemed a part of this Agreement as fully as if set forth herein. In the event of any inconsistency between an exhibit or schedule and any provision of this Agreement, such provision of this Agreement shall prevail.

**Section 21.20** Entire Agreement. The parties intend that this Agreement (including all of the attached exhibits, which are made a part of this Agreement) shall be the final expression of their agreement concerning the subject matter hereof and may not be contradicted by evidence of any prior or contemporaneous written or oral agreements or understandings. The parties further intend that this Agreement shall constitute the complete and exclusive statement of its terms and that no extrinsic evidence whatsoever (including prior drafts hereof and changes therefrom) may be introduced in any judicial, administrative or other legal proceeding involving this Agreement. Airline hereby acknowledges that neither City nor City's agents have made any representations or warranties concerning the Demised Premises or this Agreement except as expressly set forth herein, and no rights, easements or licenses are or shall be acquired by Airline by implication or otherwise unless expressly set forth herein.

**Section 21.21** Approvals. All approvals, consents, waivers, and determinations to be made by City or Commission under this Agreement can be given, withheld, or made by Director except as otherwise provided by Applicable Law, including the Charter. All approvals, consents, waivers, and determinations to be made by Airline can be made by the Airline Corporate Representative, unless otherwise provided or required in this Agreement. Without limiting the generality of the foregoing, if an Air Carrier Consortium of which Airline is a member is representing Airline for certain limited purposes under this Agreement and such representation is consistent with the organizational documents of such Air Carrier Consortium, City may rely on an approval, consent, waiver, or determination of such corporation or committee for such purposes. In no event shall an Air Carrier Consortium be authorized to amend or modify this Agreement on behalf of Airline.

**Section 21.22** Amendments. Neither this Agreement nor any terms or provisions hereof may be changed, waived, discharged or terminated, except by a written instrument signed by City and Airline. Any amendments or modifications to this Agreement, including, without limitation, amendments to or modifications to the exhibits to this Agreement, shall be subject to the mutual written agreement of City and Airline, and City's agreement may be made upon the sole approval of the Director; provided, however, material amendments or modifications to this Agreement (i) increasing the Term, (ii) changing the general use of the Demised Premises from the uses authorized in Section 2.2, and (iii) any other amendment or modification which materially increases the City's liabilities or financial obligations under this Agreement shall additionally require the approval of the Commission and the Board.

Notwithstanding anything to the contrary:

A. To the extent Airline's Demised Premises in any Terminal are recaptured, adjusted, or relocated pursuant to any term in this Agreement, such change shall be memorialized by City's issuance of a Space Change Summary Notice and shall not require or constitute a formal amendment to this Agreement; and

B. To the extent the Preferential Use Gates assigned to Airline are changed in accordance with Article 3, such annual reallocation shall be memorialized by City's issuance of the annual Preferential Use Gate allocation notice which shall be deemed to form a part of this Agreement and shall not require or constitute a formal amendment to this Agreement.

**Section 21.23** No Presumption Against Drafting Party. This Agreement has been negotiated at arm's length and between persons sophisticated and knowledgeable in the matters dealt with herein and shall be interpreted to achieve the intents and purposes of the parties, without any presumption against the party responsible for drafting any part of this Agreement.

**Section 21.24** Duty Free Merchandise and International Travel Merchandise. Airline shall not sell, take orders, deliver, or transport duty free merchandise and/or international travel merchandise ("ITM") as such terms are defined by the United States Department of the Treasury/U.S. Customs Service, and its applicable regulations and directives, on any flight into or out of the Airport under a program in which Airline solicits or accepts orders for purchase by passengers of, or delivers, ITM at any time prior to the departure of Airline's aircraft on the outbound flight from the Airport. The foregoing restriction shall apply to Airline and its Affiliate Airlines, and their respective officers, employees, affiliates, agents, and assigns. In the event City grants any other Air Carrier permission to conduct such activity, City shall offer no less favorable rights to Airline relating to ITM.

**Section 21.25** No Third-Party Beneficiaries. Except as expressly stated herein, there are no third-party beneficiaries to this Agreement.

**Section 21.26** No Joint Venture. It is expressly agreed that City is not, in any way or for any purpose, a partner of Airline in the conduct of Airline business or a member of a joint enterprise with Airline, and does not assume any responsibility for Airline's conduct or performance of this Agreement.

**Section 21.27** Nature of Agreement. Under no circumstances will City be expected or required to make any payment of any kind for Airline's use or occupancy of the Demised Premises, except as may be otherwise expressly set forth herein. Except as otherwise expressly provided herein, this Agreement shall continue in full force and effect, and the obligations of Airline hereunder shall not be released, discharged or otherwise affected, by reason of: (a) any bankruptcy, insolvency, reorganization, composition, adjustment, dissolution, liquidation or other proceeding relating to City, Airline or any constituent partner of Airline or any sublessee, licensee or concessionaire or any action taken under this Agreement by a trustee or receiver, or by any court, in any proceeding; (b) any claim that Airline or any other person has or might have against City; (c) any failure on the part of City to perform or comply with any of the terms hereof or of any other agreement with Airline or any other person; (d) any failure on the part of any sublessee, licensee, concessionaire, or other person to perform or comply with any of the terms of any sublease or other agreement between Airline and any such person; (e) any termination of any sublease, license or concession, whether voluntary or by operation of law; or (f) any other occurrence whatsoever, whether similar or dissimilar to the foregoing in each case whether or not Airline shall have notice or knowledge of any of the foregoing. The obligations of Airline hereunder shall be separate and independent covenants and agreements. Except as otherwise provided for in this Agreement, Airline hereby waives to the full extent permitted by Applicable Laws, all rights now or hereafter conferred by statute, including without limitation the provisions of Civil Code Sections 1932 and 1933, to quit, terminate or surrender this Agreement or the Demised Premises or any part thereof, or to any abatement, suspension, deferment, diminution or reduction of any rent hereunder.

**Section 21.28** Required Approvals. NOTWITHSTANDING ANYTHING TO THE CONTRARY CONTAINED IN THIS AGREEMENT, AIRLINE ACKNOWLEDGES AND AGREES THAT NO OFFICER OR EMPLOYEE OF CITY HAS AUTHORITY TO COMMIT CITY TO THIS AGREEMENT UNLESS AND UNTIL CITY'S BOARD OF SUPERVISORS SHALL HAVE DULY ADOPTED A RESOLUTION APPROVING THIS AGREEMENT AND AUTHORIZING THE TRANSACTIONS CONTEMPLATED HEREBY AND THE MAYOR SIGNS THE RELATED RESOLUTION. THEREFORE, ANY OBLIGATIONS OR LIABILITIES OF CITY HEREUNDER ARE CONTINGENT UPON ADOPTION OF SUCH A RESOLUTION, AND THIS AGREEMENT SHALL BE NULL AND VOID IF CITY'S MAYOR AND THE BOARD OF SUPERVISORS DO NOT APPROVE THIS AGREEMENT, EACH ACTING IN THEIR RESPECTIVE SOLE DISCRETION. APPROVAL OF THIS AGREEMENT BY THE AIRPORT OR THE AIRPORT COMMISSION OR AGENCY OF CITY SHALL NOT BE DEEMED TO IMPLY THAT SUCH RESOLUTION WILL BE ENACTED, NOR WILL ANY SUCH APPROVAL CREATE ANY BINDING OBLIGATIONS ON CITY.

**Section 21.29** Airline Operations Information and Planning. For planning purposes, Airline shall upon request by Director cooperate to the greatest extent possible to furnish to City any and all pertinent information regarding Airline's current and future operations (including forecasts) at Airport. City will not disclose such information unless required to by law without first having Airline's consent, unless disclosure of such information is, in the Director's sole discretion, required for the sale of bonds or other indebtedness. Notwithstanding the foregoing,

City shall be entitled, from time to time, to release consolidated statistics for all Air Carriers operating at the Airport.

**Section 21.30** Waiver of Visual Artists Rights. Airline shall not install any object in the Demised Premises that constitutes a work of visual art under the Visual Artists Rights Act of 1990 (“VARA”) unless and until Airline has (a) obtained the prior written approval of the Director and (b) provided City with a written waiver from the author of such work of visual art, in form and substance reasonably satisfactory to City, which waiver shall identify specifically the work of visual art and the uses of that work to which the waiver applies in accordance with 17 U.S.C. § 106A(e)(1). Airline shall also provide City with a similar written waiver that is effective to bar any claim by an artist for a work of fine art under the California Art Preservation Act, Cal. Civ. Code §§ 987-989.

**Section 21.31** Airport Functions. All Airport-related functions provided as of July 1, 2009, by City employees assigned to the Commission and working under the direct authority and control of the Director, including but not limited to Airport operations, custodial cleaning and facilities maintenance, planning, development, construction, financial management and accounting, information technology and telephony, parking management and operations, human resources, marketing, public relations and other administrative and governmental functions, shall continue to be provided by employees assigned to the Commission and may only be transferred to other City departments in accordance with the following procedure:

A. City shall give Signatory Airlines sixty (60) days’ notice of any proposed transfer of functions from Commission employees to other City departments.

B. Signatory Airlines shall forward any comments, questions or objections to the proposed transfer of functions in writing to the Director within sixty (60) days of receipt of such notice.

C. City shall consider and respond to such comments, questions, or objections within forty-five (45) days of receipt thereof, following which the City may implement the proposed transfer.

D. Any City department head whose department receives work relating to the Airport in such transfer of functions shall coordinate and consult with the Director at least annually to ensure that the work is performed in a manner that is efficient, meets the needs of the Airport and conforms to sound business and airport management principles. Furthermore, such work (including work orders and billings) and any payments therefor shall be properly documented to comply with interdepartmental memoranda of understanding and billing procedures established from time to time by the Commission, and FAA rules and regulations.

**Section 21.32** List of Pertinent Nondiscrimination Acts and Authorities During the performance of this Agreement, Airline, for itself, its assignees, and successors-in-interest (hereinafter referred to as the “contractor” in this Section 21.32) agrees to comply with the following non-discrimination statutes and authorities, including but not limited to:

- Title VI of the Civil Rights Act of 1964 (42 USC §2000d et seq., 78 stat. 252), (prohibits discrimination on the basis of race, color, national origin);
- 49 CFR part 21 (Non-discrimination In Federally-Assisted Programs of The Department of Transportation-Effectuation of Title VI of The Civil Rights Act of 1964);
- The Uniform Relocation Assistance and Real Property Acquisition Policies Act of 1970 (42 USC §4601) (prohibits unfair treatment of persons displaced or whose property has been acquired because of Federal or Federal-aid programs and projects);
- Section 504 of the Rehabilitation Act of 1973, (29 USC. §794 et seq.), as amended (prohibits discrimination on the basis of disability); and 49 CFR §27;
- The Age Discrimination Act of 1975, as amended (42 USC §6101 et seq.), (prohibits discrimination on the basis of age);
- Airport and Airway Improvement Act of 1982, (49 USC §471, Section 47123), as amended (prohibits discrimination based on race, creed, color, national origin, or sex);
- The Civil Rights Restoration Act of 1987, (PL 100-209), (Broadened the scope, coverage and applicability of Title VI of the Civil Rights Act of 1964, The Age Discrimination Act of 1975 and Section 504 of the Rehabilitation Act of 1973, by expanding the definition of the terms “programs or activities” to include all of the programs or activities of the Federal-aid recipients, sub-recipients and contractors, whether such programs or activities are Federally funded or not);
- Titles II and III of the Americans with Disabilities Act of 1990, which prohibit discrimination on the basis of disability in the operation of public entities, public and private transportation systems, places of public accommodation, and certain testing entities (42 USC §12131 - 12189) as implemented by Department of Transportation regulations at 49 CFR §37 and 38 and the Department of Justice regulations at 28 CFR, parts 35 and 36;
- The Federal Aviation Administration’s Non-discrimination statute (49 USC §47123) (prohibits discrimination on the basis of race, color, national origin, and sex);
- Executive Order 12898, Federal Actions to Address Environmental Justice in Minority Populations and Low-Income Populations, which ensures non-discrimination against minority populations by discouraging programs, policies, and activities with disproportionately high and adverse human health or environmental effects on minority and low-income populations;
- Executive Order 13166, Improving Access to Services for Persons with Limited English Proficiency, and resulting agency guidance, national origin discrimination includes discrimination because of limited English proficiency (LEP). To ensure compliance with Title VI, you must take reasonable steps to ensure that LEP persons have meaningful access to your programs (70 CFR at 74087 to 74100); and

- Title IX of the Education Amendments of 1972, as amended, which prohibits you from discriminating because of sex in education programs or activities (20 USC §1681 et seq.).

**Section 21.33** **Federal Fair Labor Standards Act.** This Agreement incorporates by reference the provisions of 29 USC §201, the Federal Fair Labor Standards Act (**FLSA**), with the same force and effect as if given in full text. The FLSA sets minimum wage, overtime pay, recordkeeping, and child labor standards for full and part time workers. Airline has full responsibility to monitor compliance to the referenced statute or regulation. Airline must address any claims or disputes that arise from this requirement directly with the U.S. Department of Labor – Wage and Hour Division.

**Section 21.34** **OSHA.** This Agreement incorporates by reference the requirements of 29 CFR §1910 with the same force and effect as if given in full text. Airline must provide a work environment that is free from recognized hazards that may cause death or serious physical harm to the employee. Airline retains full responsibility to monitor its compliance and their contractor's and subcontractor's compliance with the applicable requirements of the Occupational Safety and Health Act of 1970 (29 CFR §1910). Airline must address any claims or disputes that pertain to a referenced requirement directly with the U.S. Department of Labor – Occupational Safety and Health Administration.

**Section 21.35** **Electronic Signatures.** Airline and City consent to the use of Digital Signatures, affixed using the City's DocuSign platform (if available in the country of origin of Airline), to execute this Agreement and all subsequent modifications and related agreements between the parties.

## **ARTICLE 22. HAZARDOUS MATERIALS**

**Section 22.1** **Airline's Covenants.** Airline covenants the following:

A. Airline and any Airline Entity shall at all times and in all respects comply with all applicable Environmental Laws. The Release of Hazardous Materials is strictly prohibited, except as allowed by and in compliance with Environmental Laws.

B. Neither Airline nor any Airline Entity shall cause any Hazardous Material to be brought upon, kept, used, stored, generated, treated, managed, or disposed of in, on or about the Airport, or transported to, from, or within the Airport, except to the extent that such Hazardous Material, in kind and quantity, is normally necessary to Airline's conduct of the Permitted Uses under Section 2.2 and will be used, kept, and stored in compliance with all applicable Environmental Laws, the Airport Rules, and all other Applicable Laws. If Airline is required to decontaminate or conduct remediation upon the Demised Premises or dispose of Hazardous Materials under this Agreement or applicable Environmental Laws, Airline shall ensure and certify that such decontamination, remediation, or disposal complies with applicable Environmental Laws, or alternatively, such decontamination, remediation, or disposal is approved by the Bay Area Regional Water Control Board, the United States Environmental Protection Agency, or the State Department of Toxic Substances Control, or any successor agencies thereto. Any relocation and reuse of soil known to contain Hazardous Materials by



Airline at the Airport that are not naturally occurring shall be subject to the prior written consent of Director, in the sole and absolute discretion of Director.

C. Airline, at Airline's sole cost and expense, shall promptly investigate, in accordance with requirements of all applicable Environmental Laws, any Release upon the Demised Premises and shall report such Release to City within three (3) days of discovery (or such shorter time as required by Environmental Laws). Airline, at Airline's sole cost and expense, shall remediate, in accordance with requirements of all applicable Environmental Laws, any Release, including but not limited to, a Release which was caused by or results in whole or in part from the activities of Airline or any Airline Entity, but excluding: (a) the disposal of Hazardous Materials through the Airport's sewage system, so long as such disposal complies with Environmental Laws and any pre-discharge treatment requirements issued by the Airport or (b) the portions of said Release that the Airline demonstrates, to the reasonable satisfaction of the City, were caused exclusively by the City or City Entity or other third party not under the authority or control of Airline or an Airline Entity or (c) any Release expressly allowed by a valid permit issued under applicable Environmental Laws.

In addition to any remedy provided in this Agreement, City, in its discretion, may after reasonable advance written notice to Airline (except that notice is not required for any Release that poses an imminent risk of harm to health, property, or the environment or other emergency situation), pay to have such Release investigated and remediated as required by applicable Environmental Laws, and Airline shall reimburse City for Airline's share of the documented costs within thirty (30) days of City's demand for payment if: (a) Airline does not promptly commence investigation of any such Release; or (b) Airline does not diligently pursue appropriate remedial activities required by applicable Environmental Laws; or (c) City determines that its performance of the investigation and/or remediation is needed to achieve the City's operational needs or construction objectives. The failure of Airline to commence investigation and provide City with a preliminary schedule for diligent pursuit of any required remediation within thirty (30) business days after (a) Airline's discovery of such Release (or such shorter time as required by applicable Environmental Laws) or (b) notice of such Release shall constitute prima facie evidence of failure to promptly commence investigation and remediation.

D. Airline shall provide Director with a copy of any application for a permit, if required, for use or storage of Hazardous Materials on the Airport from any regulatory agency responsible for enforcement of applicable Environmental Laws and shall also provide a copy of any such permit received from such agency.

**Section 22.2** Access for Environmental Inspection. City shall have reasonable access to the Demised Premises to inspect the same in order to confirm that Airline is using the Demised Premises in compliance with Environmental Laws. Unless an emergency condition arises that makes advance notice impracticable, City will, where practical, give Airline reasonable advance written notice of the inspection and the opportunity to have an Airline representative present during the inspection. Airline shall cooperate fully with any such inspections provided that such inspections shall not unreasonably interfere with Airline's operations.

**Section 22.3** **Liability.** In addition to any remedy provided in this Agreement, Airline shall be solely and fully responsible and liable for costs, including without limitation costs of investigation, clean-up or other remedial activities, fines or penalties assessed directly against the Airport, attributable to (a) storage, use, or disposal of Hazardous Materials on the Airport by Airline or any Airline Entity or (b) a Release caused by, contributed to, or resulting from the activities of Airline or any Airline Entity.

**Section 22.4** **Environmental Indemnity.** Airline shall indemnify, defend, and hold harmless City from and against any and all claims, causes of action, regulatory demands, liabilities, fines, penalties, losses, and expenses, including without limitation clean-up or other remedial costs and attorneys' fees, resulting or arising from: (a) a breach by Airline of any obligations contained in this Article 22; (b) any Release caused by the act or omission of Airline or any Airline Entity or otherwise arising from Airline's operations hereunder; or (c) the existence of any Hazardous Materials on the Demised Premises, except to the extent Airline can demonstrate to the reasonable satisfaction of City that (i) such Hazardous Materials constitute a Pre-Existing Condition and Airline or Airline Entity did not exacerbate such Pre-Existing Condition so as to require additional remedial action under applicable Environmental Laws or (ii) such Hazardous Material was exclusively contributed to the Demised Premises by City or a City Entity or a third party not under authority or control of Airline Entity or an Airline Entity. Nothing herein shall constitute a release of Airline for any losses arising out of any Pre-Existing Conditions to the extent Airline is responsible therefore pursuant to any other agreement or law.

**Section 22.5** **Environmental Audit.** Upon reasonable advance written notice, Director shall have the right but not the obligation to conduct or cause to be conducted by a firm acceptable to Director, an environmental audit of the Demised Premises and Airline's operations, equipment, and fixtures thereon for the purpose of assessing Airline's compliance with this Article 22 and applicable Environmental Laws. City will give Airline an opportunity to have an Airline representative present during the audit. If the audit identifies a Release for which Airline is liable under this Article 22, Airline shall pay all reasonable costs associated with the audit, provided City's actions are consistent with Section 22.1(C). Airline shall have the opportunity to review and comment on the report of the audit results prior to finalization, which comments the City shall reasonably consider for incorporation into the final audit report. Airline will promptly correct any deficiencies recommended by the auditor in the final audit report.

**Section 22.6** **Notice by Airline.** Airline shall give City verbal and written notice of any unauthorized Release known to Airline, except for Releases considered to be de minimis under applicable Environmental Laws. Such notice shall conform with Section 22.1(C) and the any applicable procedures established in the Airport Rules. In addition, to the extent known to Airline, Airline shall notify City in writing of Airline's knowledge of: (a) Pre-Existing Condition other than those previously disclosed to the Airline by City; (b) enforcement, investigation, clean-up, remediation or other government or regulatory action instituted, completed or threatened against Airline or the Airport pursuant to applicable Environmental Laws; (c) claim made or threatened by any person against Airline or the Airport relating to a Release or Hazardous Materials on or about the Demised Premises or property adjoining or in the vicinity of the Airport; and (d) reports made by Airline to any environmental agency arising

out of or in connection with a Release or Hazardous Materials on or about the Demised Premises or property adjoining or in the vicinity of the Airport, or pursuant to any applicable Environmental Laws. Airline shall also supply to City as promptly as possible, and in any event within ten (10) business days after Airline first receives, or sends copies of all claims, reports, complaints, notices, warnings, and any other communications asserting violations of Environmental Laws by Airline relating in any way to the Demised Premises or Airline's use thereof.

**Section 22.7** Stormwater. Notwithstanding any other provisions or terms of this Agreement, Airline acknowledges that certain properties within the Airport are subject to applicable Environmental Laws relating to stormwater. Airline agrees to observe and abide by such applicable Environmental Laws relating to stormwater that apply to City's property and Airline's use thereof.

A. City and Airline both acknowledge that cooperation is necessary to ensure compliance with stormwater discharge permit terms and conditions, to ensure safety, and to minimize costs of compliance. Airline acknowledges further that it must implement and maintain best management practices to minimize the exposure of stormwater to contaminants generated, stored, handled, or otherwise used by Airline.

B. City will from time to time provide Airline with written notice of City's stormwater discharge permit requirements applicable to those areas of the Demised Premises in which Airline conducts activities that are regulated under City's stormwater discharge permit and with which Airline must comply, including, but not limited to: certifying of non-stormwater discharges; collecting stormwater samples preparing stormwater pollution prevention or similar plans; implementing best management practices; and maintaining records. Such written notice shall provide reasonable advance notice of applicable deadlines. Airline agrees that within thirty (30) days of receipt of such written notice it shall notify City in writing if it disputes any of the stormwater permit requirements it is directed to undertake. If Airline does not provide such timely notice, Airline will be deemed to assent to undertake such stormwater permit requirements applicable to Airline's operations. In that event, Airline agrees to undertake, at its sole expense, unless otherwise agreed in writing between City and Airline, those stormwater permit requirements applicable to Airline's operations for which it has received written notice from City, and Airline agrees that it will hold harmless and indemnify City for any violations or non-compliance with any such permit requirements. Additionally, City will notify Airline of new or revised stormwater permit conditions that directly affect the Airline.

**Section 22.8** Airline Obligations Upon Termination. Prior to vacating the Demised Premises, and in addition to all other requirements under this Agreement and without limiting Airline's indemnification obligations herein, Airline shall:

A. Remove any Hazardous Materials used, stored or Released by Airline on the Demised Premises except (i) to the extent Airline demonstrates to the reasonable satisfaction of City that the Hazardous Material constitutes a Pre-Existing Condition and Airline or Airline Entity did not exacerbate the Pre-Existing Contamination; (ii) to the extent the Airline can demonstrate to the reasonable satisfaction of City that the Hazardous Material was exclusively contributed to the Demised Premises by City or City Entity or a third party not under the

authority or control of Airline or an Airline Entity; or (iii) said Hazardous Material is addressed pursuant to Section 22.8(B). Moreover, Airline shall demonstrate to City's reasonable satisfaction that such removal complies with all applicable Environmental Laws, including without limitation conducting any environmental audits and/or site investigations as may be reasonably required by City to demonstrate such removal has been completed according to the terms of this Agreement. This removal and demonstration shall be a condition precedent to City's return of the Deposit, if any, to Airline upon termination or expiration of this Agreement.

B. With respect to any Hazardous Materials on the Demised Premises not removed pursuant to Section 22.8(A) above and not subject to any exceptions, Airline shall promptly investigate and remediate the Hazardous Materials in accordance with the requirements of all applicable Environmental Laws ("**Airline's Remediation**"). If Airline's Remediation will leave Hazardous Materials at the Airport (including but not limited to in the soil or groundwater), prior to completion of the remediation, the Airline shall: (i) obtain the City's written determination that the Hazardous Materials will not interfere with any reuse of the Demised Premises reasonably contemplated or anticipated by the City; (ii) provide the City with a plan for long-term monitoring and /or remediation of the Hazardous Materials that is approved by the appropriate regulatory agencies; and (iii) provide the City with a written acknowledgement of responsibility for the remediation and indemnification for any and all losses or disruption associated with Airline's failure to remove the Hazardous Materials. The Airline's full compliance with this Section 22.8 shall be a condition precedent to the City's return of the Deposit, if any, to Airline upon termination or expiration of this Agreement.

**Section 22.9** Cumulative Remedies. All remedies of the City regarding Hazardous Materials or any actual or threatened violations of Environmental Laws are cumulative in nature and shall supplement, and not replace, any other right City may have under this Agreement or Applicable Laws. The City's right to indemnification provided in this Article 22 shall survive the expiration or early termination of this Agreement with respect to occurrences during the Term of this Agreement.

**Section 22.10** Prior Agreements. Notwithstanding any provisions in this Agreement, nothing herein shall affect the terms and conditions of any prior settlement agreements reached between City and Airline relating to Hazardous Materials, including the settlement agreement addressing the claims asserted in the civil action captioned City and County of San Francisco v. Atlantic Richfield, et al. (N.D. Cal. Case No. C97-2965), and nothing herein shall be construed in any way to limit the releases granted by the parties in those prior settlement agreements.

## **ARTICLE 23. ENVIRONMENTAL SUSTAINABILITY**

**Section 23.1** General Sustainability Measures. From time to time, City may adopt certain environmental sustainability measures to minimize the environmental footprint of Airport operations. Air Carriers operating at the Airport may also pursue various sustainability measures. City encourages such initiatives and from time to time may call upon Airline to cooperate with City in implementing sustainability measures that impact Airline operations such as completing tenant improvements to Leadership in Energy and Environmental Design (**LEED**) Gold or better standards, energy and water conservation, solid waste reduction and recycling measures, electrification of ground services equipment, maximizing the use of preconditioned air, or single

engine taxiing, provided that such sustainability measures comply with Applicable Laws. Airline agrees to implement sustainability measures as required to meet Applicable Laws. In addition, Airline agrees to comply with mandatory standards and policies applicable to Airline and its use and operations at the Airport relating to energy efficiency as contained in any State of California energy conservation plan issued in compliance with the Energy Policy and Conservation Act (42 USC 6201 *et seq.*).

**Section 23.2 Sustainable Aviation Fuel Working Group.** In addition to the foregoing, City and Airline agree that increased uptake of SAF by Airline is a shared priority, and Airline agrees to make commercially reasonable efforts to pursue that goal during the term of the Agreement. Upon the request of City, Airline will participate in a working group, chaired by the Director, and include appropriate representatives from Airline to identify areas where the parties can cooperate to increase the uptake of SAF by Air Carriers, which may include, without limitation, development of policies, improvements at the Airport to address means of delivery and distribution, and the implementation of financial incentive programs at the Airport to encourage use of SAF by Air Carriers or other sustainable products or technologies that would help reduce greenhouse gas emissions at the Airport and by Air Carriers serving the Airport, to the extent permitted by Applicable Laws (the “**SAF Working Group**”). Airline may appoint a single representative to the SAF Working Group, or together with one or more Airlines, collectively appoint a representative to the SAF Working Group, provided such representative is sufficiently informed and qualified to represent each Airline’s interest at meetings of the group.

**Section 23.3 Ground Service Equipment Electrification.** City and Airline agree that each party will work together towards a mutual goal of converting all ground service equipment in use at the Airport to operate using 100% electricity as a power source, or such other more sustainable fuel than gasoline in use as of the Effective Date. In connection with any such electrification, City shall use all commercially reasonable efforts to install the required electrical infrastructure for such ground service equipment, and any Capital Improvements of City necessary to implement such infrastructure shall not be subject to the provisions of Section 6.2(B) and (C).

## **ARTICLE 24. DIGITAL INFORMATION WORKING GROUP; AIRPORT DIGITAL ASSETS**

**Section 24.1 Digital Information Working Group.** In furtherance of enhancing the efficiency of Airport operations and the guest experience at the Airport, upon the request of City, Airline shall participate in a digital information working group, chaired by Director and include appropriate technology representatives from Airline, that will identify information on Airport infrastructure and Airline operations that, consistent with considerations of confidentiality, competition, security, privacy and Applicable Laws, could be exchanged in real-time between City and Airlines (the “**Digital Information Working Group**”). The Digital Information Working Group will further identify the potential means, methods, and terms of sharing such information, including, without limitation, information systems compatibility, feasibility and costs of systems integration, responsibility for information security, and ownership and commercial use of such information. In addition to the foregoing, to the extent Airline offers a

passenger-facing mobile application tailored to Airport, Airline agrees to coordinate with City on the feasibility of offering information on concessions, services, and amenities at the Airport.

**Section 24.2 Commercialization of Airport Digital Assets.**

A. City will have the sole and exclusive right to control, manage and exploit for commercial and non-commercial purposes all Airport Proprietary Content. Airline acknowledges and agrees that, to the extent it wishes to exploit or use Airport Proprietary Content for any purpose (including, without limitation, providing any Airport Proprietary Content to its customers through digital means such as mobile applications, virtual reality, augmented reality, or other non-physical means or methods), it will disclose the intended use and context for such use and seek prior written consent of City, as appropriate, which such consent may be granted or withheld in the sole and absolute discretion of City, and for which compensation may be required as a condition of such use.

B. For purposes of this Agreement, “**Airport Proprietary Content**” means all content and assets generated, owned, controlled or exclusively possessed by City (virtual or real world, including data) as it relates to its ownership of the Airport, including any derivative products therefrom, which such content may or may not be evidenced by an intellectual property ownership interest, including, without limitation, trademark, patent or copyright. Airport Proprietary Content does not fail to be proprietary as it relates to City due to City’s status as a governmental entity or that it may be required to be produced under applicable public records laws. For illustration purposes only, Airport Proprietary Content includes, without limitation, the following content and assets: (i) the SFO logo; (ii) interior plans, drawings, photos or videos of the Airport premises generated by City or its contractors (including artificial generation); (iii) flysfo.com and all associated web addresses; (iv) Airport marketing and promotional programs and materials; (v) informational surveys of customers and tenants; (vi) software and other technology programs generated by City or its contractors; (vii) nonpublic information, written, electronic, or oral, relating to Airport infrastructure, technology, computer, or data systems, processes, or procedures, including but not limited to Private Information as defined under San Francisco Administrative Code Chapter 12M, and Sensitive Security Information as defined under 49 CFR Part 1520 (SSI) generated by City or its contractors. City reserves the right from time to time to designate additional specific assets or types of assets generated, owned, controlled or exclusively possessed by City (virtual or real word, including data) as it relates to its ownership of the Airport and consistent with the illustrative examples listed above as Airport Proprietary Content by written notice of the same to Airline.

[END OF AGREEMENT]

IN WITNESS WHEREOF, the parties hereto have executed this Agreement in duplicate by their duly authorized officers the day and year first hereinabove written.

AIRLINE: Japan Airlines Co., Ltd.,  
a company formed under the laws of Japan

DocuSigned by:  
Taiki Ozawa  
6A7BB18A30244DC... Taiki Ozawa  
Vice President, Western Region

DocuSigned by:  
C.H.  
EF2BD79333C249E... Chikahiro Honda  
Director, Administration

CITY: CITY AND COUNTY OF SAN FRANCISCO  
a municipal corporation,  
acting by and through its Airport Commission

\_\_\_\_\_  
Ivar C. Satero  
Airport Director

AUTHORIZED BY AIRPORT COMMISSION

Resolution No.: 23-0035

Adopted: February 7, 2023

Attest: \_\_\_\_\_  
Secretary  
Airport Commission

APPROVED AS TO FORM:  
DAVID CHIU, City Attorney

By: \_\_\_\_\_  
Christopher W. Stuart  
Deputy City Attorney

12.30.2022  
Y:\AVMGT\PROJECTS\Lease & Use Agreement 2023\Final Leases\Japan Airlines 2023 L&U.docx

## **List of Exhibits**

- Exhibit A: Map of Airport
- Exhibit B: [Reserved]
- Exhibit C: Maintenance and Operations Responsibilities
- Exhibit D: Description of Demised Premises and Space Drawings
- Exhibit E-1: Joint Use Formula for International Operations
- Exhibit E-2: Joint Use Formula for Domestic Operations
- Exhibit F: Calculation of Common Use Gate Domestic Operations Fee
- Exhibit G: Management Protocols for Joint Use, Common Use and Shared Use Equipment
- Exhibit H: Gate Management Protocols
- Exhibit I: [Reserved]
- Exhibit J: Illustration of Domestic Terminals Preferential Use Gate Assignment Formula
- Exhibit K: Rents for Airline's Demised Premises (FY 2022/23)
- Exhibit L: Form of Space Change Summary Notice
- Exhibit M: List of Baseline Environmental Reports
- Exhibit N: Airport Measurement Specifications
- Exhibit O: Calculation of Rates and Charges
- Exhibit P: Form of Activity Report
- Exhibit Q: Form of Capital Project Review Form
- Exhibit R: Example of Calculation of Annual ORCIF Deposit and Allocation to Cost Centers



# EXHIBIT A MAP OF AIRPORT

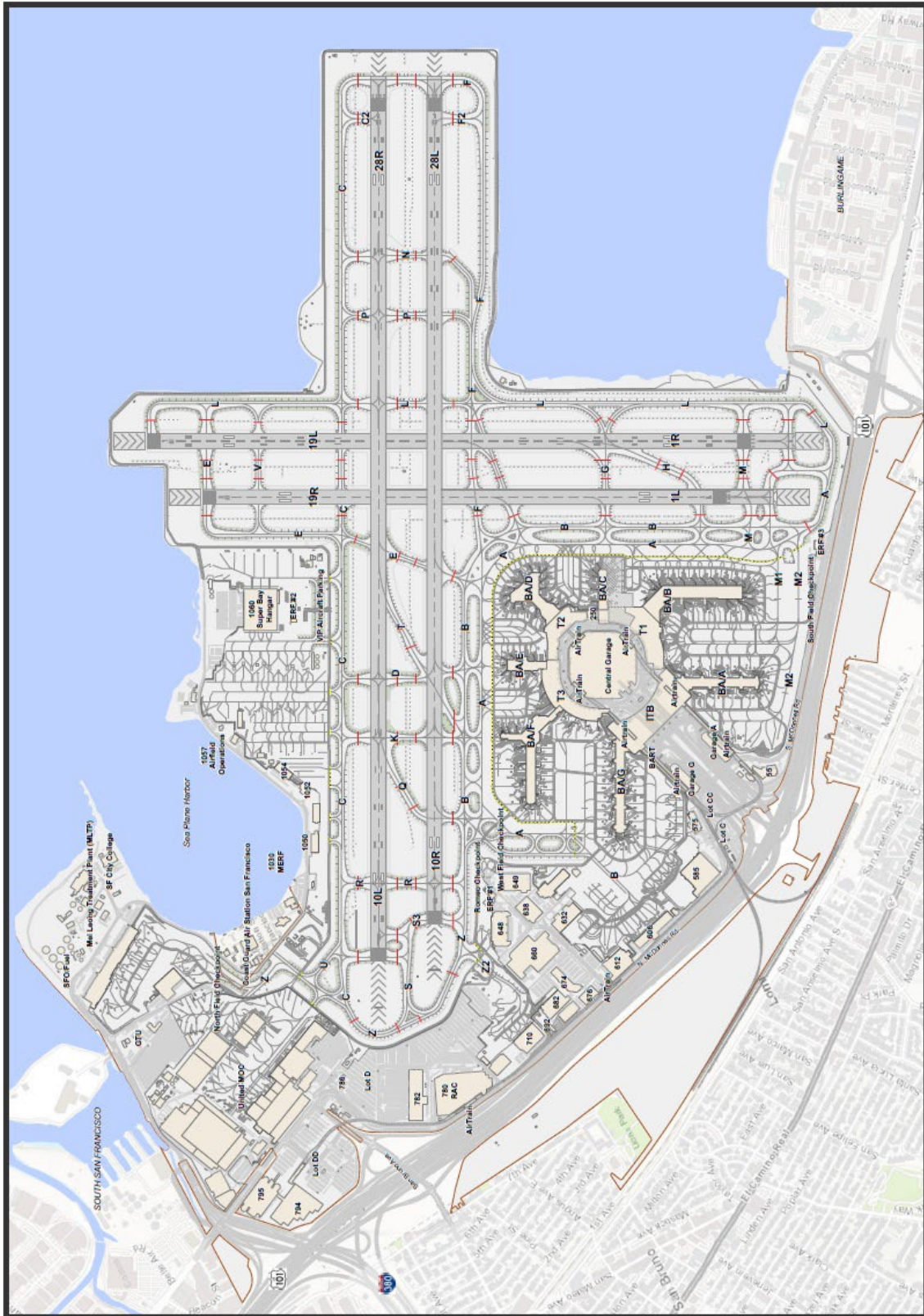



**EXHIBIT B  
RESERVED**

## EXHIBIT C MAINTENANCE AND OPERATIONS RESPONSIBILITIES

	TERMINAL BUILDINGS						AIR OPERATIONS AREA			
	Leased Space - Full Public Exposure <sup>1</sup>	Leased Space Unexposed <sup>2</sup>	Airline Leasable Vacant	Common Use & Joint Use Space	FIS Space	Public Space	Runways	Taxiways	Parking Ramps <sup>3</sup>	Cart Roads
HVAC -- Central Heating and Cooling to Premises	C	C	C	C	C	C	---	---	---	---
-- Heating of Premises	C	A	C	C	C	C	---	---	---	---
-- Cooling of Premises	C	A	C	C	C	C	---	---	---	---
Water and Sewerage	---	A <sup>4</sup>	C	C	C	C	---	---	---	---
Power Supply to Premises <sup>5</sup>	C	C	C	---	C	C	C	C	C	C
Lighting <sup>6</sup>	C	A	C	C	C	C	C	C	C	C
Cleaning <sup>7</sup>	C	A	C	C	C	C	C	C	A	C
Trash Removal	C	A	C	C	C	C	C	C	A	C
Window Washing - Interior	C	A	C	C	C	C	---	---	---	---
- Exterior	C	C	C	C	C	C	---	---	---	---
Decorative/Maintenance/Replacement/Repair: Walls, Doors, Furniture, Fixture, Windows, Ceilings, Carpets, Floors, Floor Mats, Baggage Scales	C	A	C	C	C	C	---	---	---	---
Plumbing and Fixtures	---	A	C	C	C	C	---	---	---	---
Building: - Structural	C	C	C	C	C	C	---	---	---	---
- Interior	C	A	C	C	C	C	---	---	---	---
- Exterior	C	C	C	C	C	C	---	---	---	---
Paving - Repair and Replacement	C	C	C	C	C	C	C	C	C	C
Baggage: - Claim Devices	O	O	---	C	A	C	---	---	---	---

<sup>1</sup> Includes Check-In Counters, Holdrooms, Podiums, Baggage Claim Areas. City's responsibility at Check-In counter starts on the passenger facing side (where passengers stand). Behind check-in counter the airline is responsible for clean-up/trash removal.

<sup>2</sup> Includes Offices, VIP Clubs/Lounges, Baggage Operations, Storage/Equipment Rooms.

<sup>3</sup> Includes aircraft envelope and immediate surroundings including GSE staging areas, including trash receptacles and triturators.

<sup>4</sup> Airport will inspect and maintain potable water backflow devices. Usage shall be estimated or measured by meter.

<sup>5</sup> Usage of all power shall be estimated or measured by meter. Meters to be installed at Airline's expense.

<sup>6</sup> Lighting shall mean general illumination and shall include relamping and replacement of the Airport's standard starters, ballasts, switches and outlets but shall not include special airline installations or requirements.

<sup>7</sup> Excludes Check-In Counters and passenger loading bridge interiors. Physical cleanup of Check-in Counters and trash removal.

Key: A-Airline/ C-City/ T-Non-Airline  
 Tenant, O-Owner of Equipment

	TERMINAL BUILDINGS						AIR OPERATIONS AREA			
	Leased Space - Full Public <u>Exposure</u> <sup>1</sup>	Leased Space <u>Unexposed</u> <sup>2</sup>	Airline Leasable <u>Vacant</u>	Common Use & Joint Use <u>Space</u>	FIS <u>Space</u>	Public <u>Space</u>	<u>Runways</u>	<u>Taxiways</u>	<u>Parking Ramps</u> <sup>3</sup>	<u>Cart Roads</u>
- Conveyors & Makeups	O	O	---	C	A	C	---	---	---	A
Passenger Loading Bridges Maint <sup>8</sup> .	O	O	---	C	---	---	---	---	---	---
PBB Ground Power & PreConditioned Air <sup>9</sup>	O	O	---	C	---	---	---	---	---	---
Keys and Locks	A	A	C	C	T	C	---	---	---	---
Security Doors	C	C	C	C	C	C	---	---	---	---
Fuel Lines	---	---	---	---	---	---	---	A	A	A
Electric Vehicle Charging Ports <sup>10</sup>	O	O	--	C	--	---	---	---	O	---
Pest Control	A	A	A	C	C	C	---	---	---	---

<sup>8</sup> Airlines responsible for all janitorial (trash removal and cleaning) for passenger loading bridges.

<sup>9</sup> Airlines responsible for cable and hoses from passenger loading bridges to aircraft.

<sup>10</sup> Airlines responsible for cables and connectors.

**EXHIBIT D**  
**DESCRIPTION OF DEMISED PREMISES AND SPACE DRAWINGS**

The Demised Premises consist of the following:

**EXCLUSIVE USE SPACE**, as more particularly described on Airport Drawings Numbers specified on the List of Drawings attached hereto.

Type	Terminal	Category	Square Feet
Check-In Counters & Kiosks	-	I	-
Other Category I	-	I	-
Airline Ticket Office (ATO)	IT	II	309
VIP Clubs and Lounges	-	II	-
Other Enclosed Space Departure Level and above	IT	II	1,455
Baggage Claim Lobbies	-	II	-
Baggage Service Offices	-	II	-
Curbside Check-in	-	II	-
Other Enclosed Space, Arrivals Level and below	IT	III	430
Inbound/Outbound Baggage Handling Areas and Baggage Transfer Areas	-	IV	-
Equipment Rooms	-	IV	-
Unenclosed or Covered Area - Ramp Level	-	V	-

**INTERNATIONAL JOINT USE SPACE**, as more particularly described on Airport Drawings Numbers specified on the List of Drawings attached hereto. Airport Director may update the following table of International Joint Use Space from time to time by written notice to the affected Air Carriers without any requirement for a modification or amendment of this Lease.

Type	Terminal	Category* (J/U type)	Square Feet
Check-In Counter & Kiosks	IT	I (e)	24,064
Holdroom	IT	I (e)	See below
Other Category I	IT	I (e)	-
Baggage Claim/FIS	IT	II (d)	215,775
Other Category II	IT	II (t)	544
Other Enclosed Common Use, Arrivals Level and below	IT	III (t)	3,410
Inbound Baggage Makeup	IT	IV (d)	121,348
Outbound Baggage Makeup	IT	IV (e)	140,601

<b>Type</b>	<b>Terminal</b>	<b>Category* (J/U type)</b>	<b>Square Feet</b>
Other Unenclosed Space	IT	V (t)	1,888

\* The Category references are utilized in the Joint Use Formulas, as follows: (e): enplaned / (d): deplaned / (t): total.

## **INTERNATIONAL JOINT USE SPACE ADJUSTMENT FOR SWING CONTACT GATE HOLDROOMS**

The following method shall be used to calculate the proportion of the total square footage of all Swing Contact Gate holdrooms to be included as demised Joint Use Space for purposes of rate setting only, and not for establishing the boundaries of the demised premises of any Joint Use Space. Holdrooms associated exclusively with Remote Swing Gates, if any, are not subject to adjustment described in this Exhibit and are included in Joint Use Space on an actual square footage basis.

1. The City shall calculate the total square footage of all holdrooms associated with Swing Contact Gates.
2. The City shall calculate the number of holdrooms required by dividing its annual international enplanements forecast, excluding enplanements to Canadian airports with U.S. Customs and Border Protection preclearance facilities, by the number of days in the year, and divide that result by eight hundred thirty-five (835).
3. The result of the calculation in step [2] will be rounded to the nearest whole number.
  - a. If the result of the calculation in step [3] is less than sixteen (16), it will be increased to sixteen (16). If for any reason the total number of Swing Contact Gates in service is less than sixteen (16), then this clause shall not apply.
  - b. If the result of the calculation in step [3] is greater than the total number of Swing Contact Gates, then it will be set as equal to the total number of Swing Contact Gates.
4. The adjustment factor shall be the ratio of adjusted holdrooms calculated in step [3] to the total number of swing contact gates in service.
5. The square footage to be assigned as Joint Use Space for purposes of rate-setting shall be the total square footage calculated in step [1] multiplied by the adjustment factor calculated in step [4].

Square footage excluded from Joint Use Space as provided in this section shall be considered Public Space for purposes of rate setting.

**PREFERENTIAL USE GATES.** Preferential Use Gates are allocated annually in accordance Article 3.



**LIST OF DRAWINGS**

<b><u>EXCLUSIVE USE SPACE</u></b>	<b><u>Drawing No.</u></b>	<b><u>Dated</u></b>
International Terminal, 1 <sup>st</sup> Floor	JLBAA1E	July 1, 2023
International Terminal, 2 <sup>nd</sup> Floor	JLBAA2E	July 1, 2023
International Terminal, 3 <sup>rd</sup> Floor	JLBGAA3E	July 1, 2023
International Terminal, 5 <sup>th</sup> Floor	JLBAA5E	July 1, 2023

<b><u>INTERNATIONAL JOINT USE SPACE</u></b>	<b><u>Drawing No.</u></b>	<b><u>Dated</u></b>
International Terminal, 1 <sup>st</sup> Floor	IT1JT	July 1, 2023
International Terminal, 2 <sup>nd</sup> Floor	IT2JT	July 1, 2023
International Terminal, 3 <sup>rd</sup> Floor	IT3JT	July 1, 2023
Boarding Area A, 1 <sup>st</sup> Floor	BAA1JT	July 1, 2023
Boarding Area A, 1 <sup>st</sup> Floor Mezzanine	BAA1MJT	July 1, 2023
Boarding Area A, 2 <sup>nd</sup> Floor	BAA2JT	July 1, 2023
Boarding Area A, 3 <sup>rd</sup> Floor	BAA3JT	July 1, 2023
Boarding Area G, 1 <sup>st</sup> Floor	BAG1JT	July 1, 2023
Boarding Area G, 2 <sup>nd</sup> Floor	BAG2JT	July 1, 2023
Boarding Area G, 3 <sup>rd</sup> Floor	BAG3JT	July 1, 2023
Boarding Area B, 2 <sup>nd</sup> Floor	T12HOLDROOMS – IT	July 1, 2023

**PREFERENTIAL USE GATES**

Not applicable

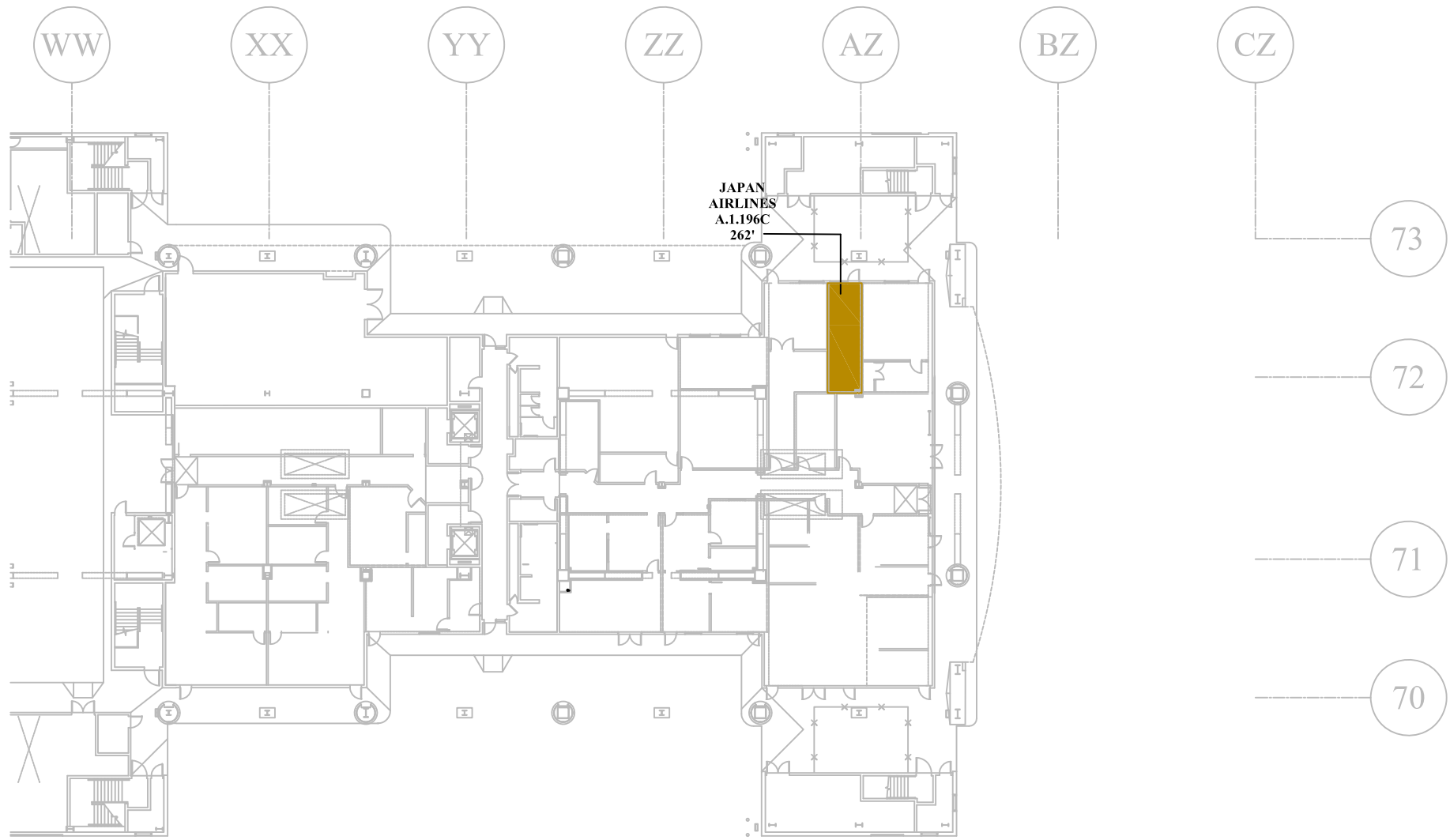

J:\AutoCAD\LEASE\AIRLINE\JAPAN AIRLINES\JLBAA1E.dwg, 12/22/2022, 3:20:13 PM, Adobe PDF

# LEASE DRAWING

LOCATION: INTERNATIONAL TERMINAL, BOARDING AREA 1, LEVEL 1  
 TENANT: JAPAN AIRLINES  
 AIRPORTS COMMISSION  
 CITY & COUNTY OF SAN FRANCISCO  
 SAN FRANCISCO INTERNATIONAL AIRPORT

DWG: JLBAA1E  
 DATE: 07/01/2023

ROOM NUMBER	AREA	CAT	CONTRACT	EFF. DATE
A.1.196C	262'	III		

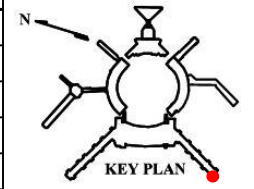

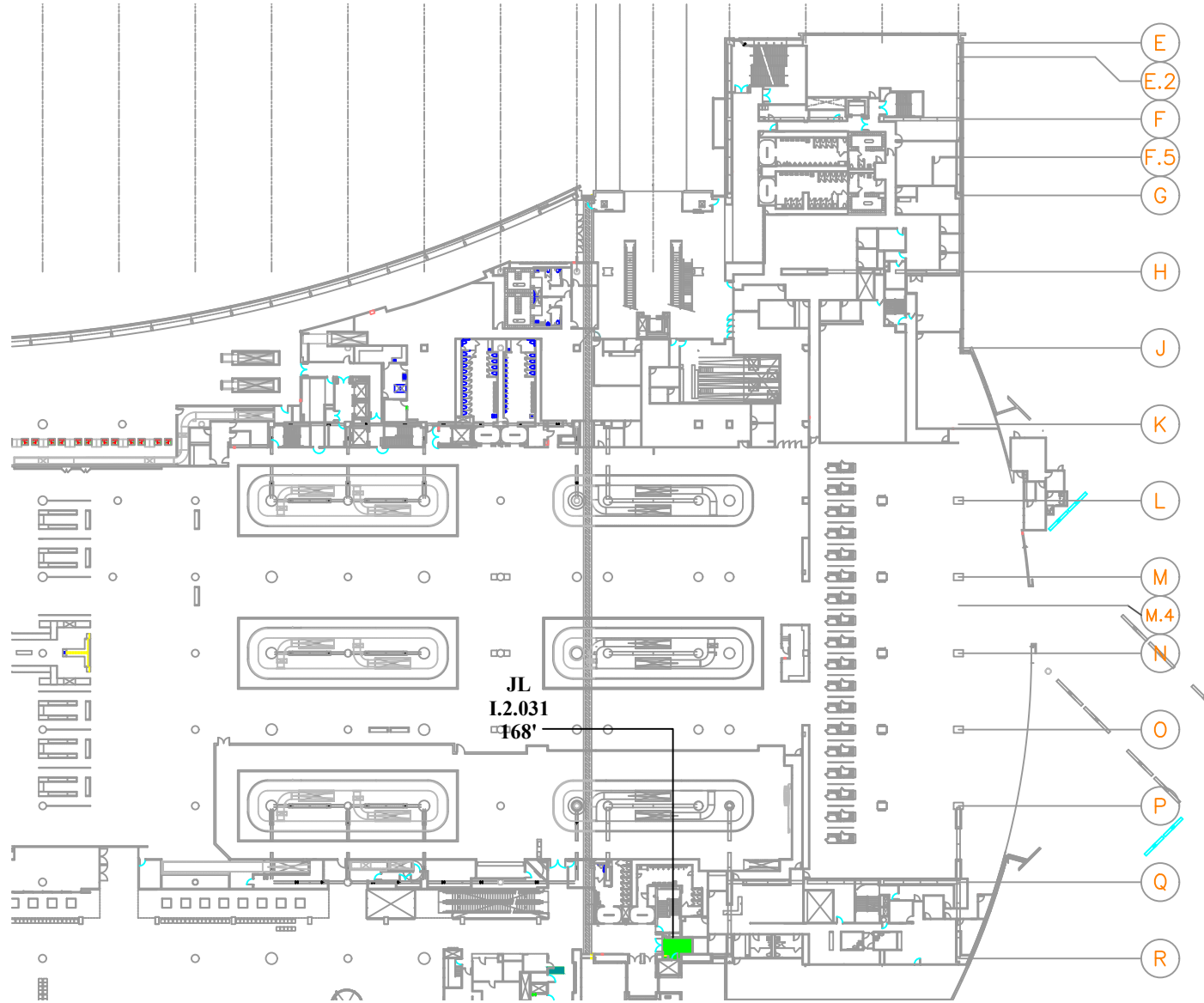

# LEASE DRAWING

LOCATION: INTERNATIONAL TERMINAL - 2ND FLOOR

TENANT: JAPAN AIRLINES

AIRPORTS COMMISSION

DWG: JLBA2E

CITY & COUNTY OF SAN FRANCISCO

DATE: 07/01/2023

SAN FRANCISCO INTERNATIONAL AIRPORT

SCALE: NTS

ROOM NUMBER	AREA	CAT	CONTRACT	EFF. DATE
I.2.031	168'	III		

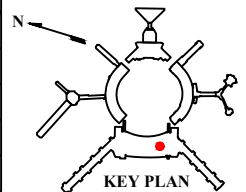

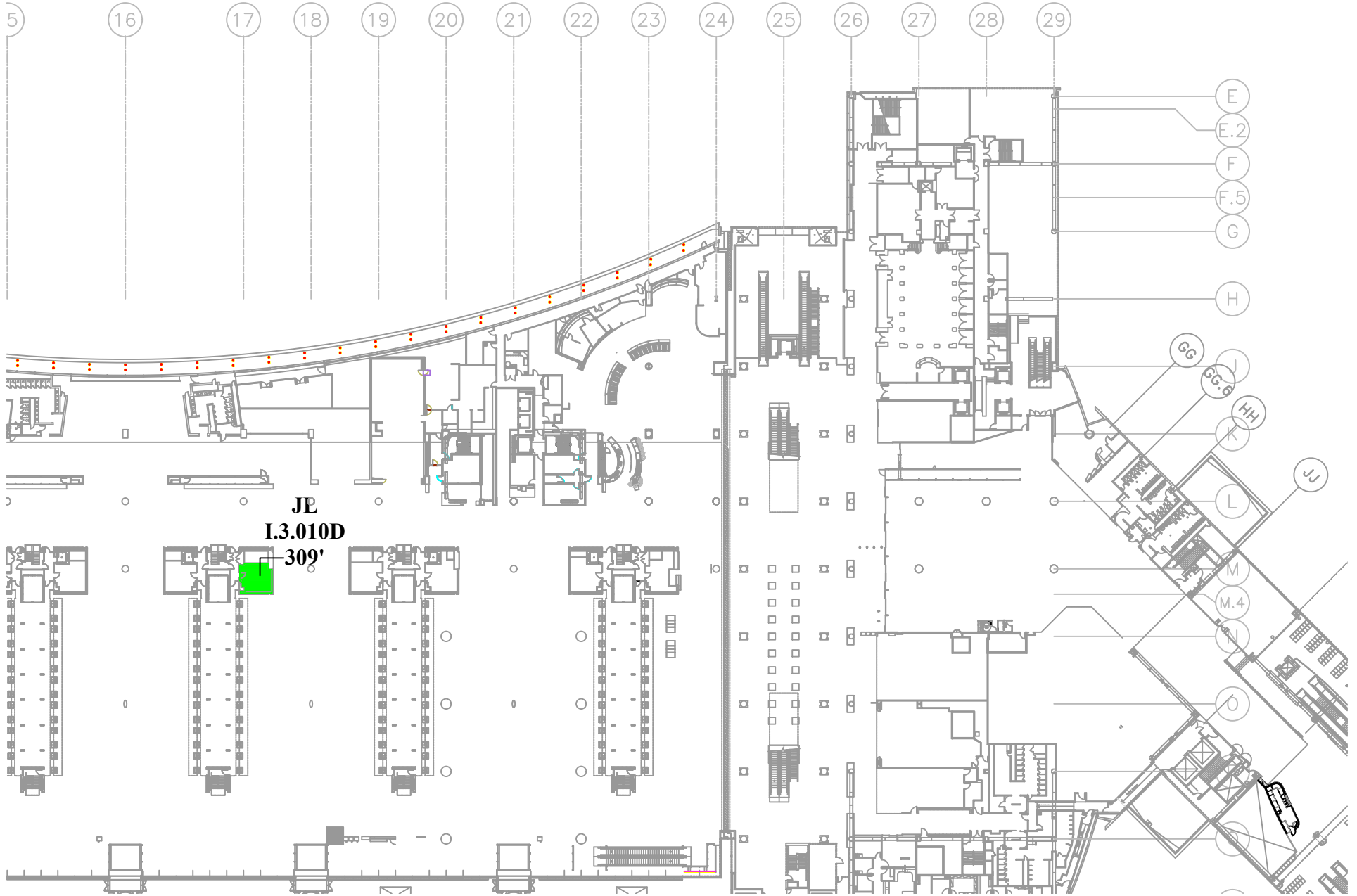

# LEASE DRAWING

**LOCATION:** INTERNATIONAL TERMINAL LEVEL 3

**TENANT:** JAPAN AIRLINES

**AIRPORT COMMISSION**

**CITY & COUNTY OF SAN FRANCISCO**

**SAN FRANCISCO INTERNATIONAL AIRPORT**

**DWG:** JLBAA3E

**DATE:** 07/01/2023

**SCALE:** NTS

ROOM NUMBER	AREA	CAT	CONTRACT	EFF. DATE
I.3.010D	309'	II		

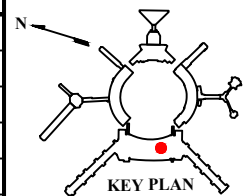

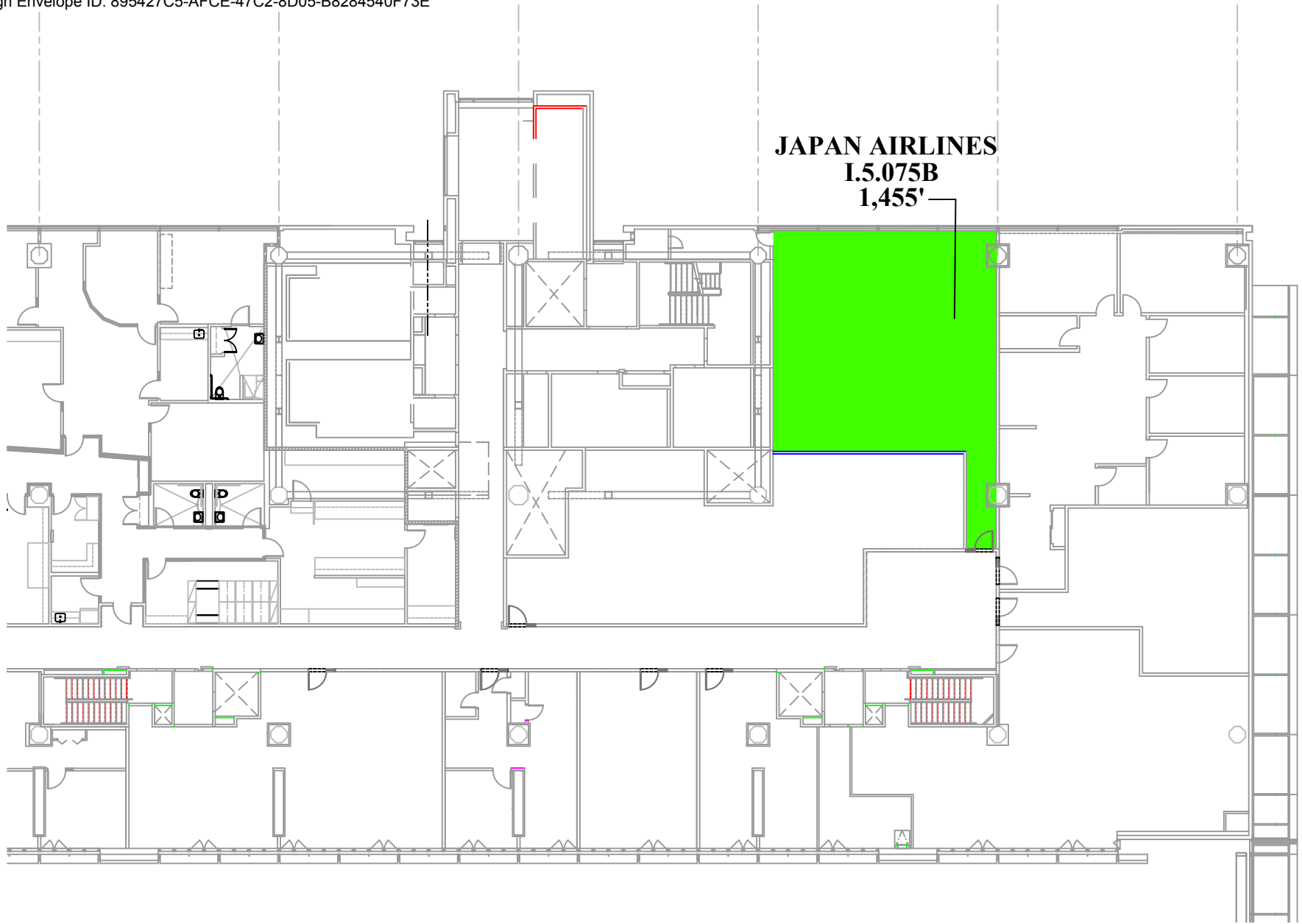

# LEASE DRAWING

**LOCATION: INTERNATIONAL TERMINAL - LEVEL 5**

**TENANT: JAPAN AIRLINES**

**AIRPORTS COMMISSION**

**DWG: JLBA05E**

**CITY & COUNTY OF SAN FRANCISCO**

**DATE: 07/01/2023**

**SAN FRANCISCO INTERNATIONAL AIRPORT**

**SCALE: NTS**

ROOM NUMBER	AREA	CAT	CONTRACT	EFF. DATE
I.5.075B	1,455'	II		

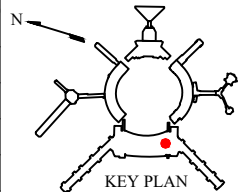

I:\AutoCad\LEASE\newitb\aviation\joint\IT1JT.dwg

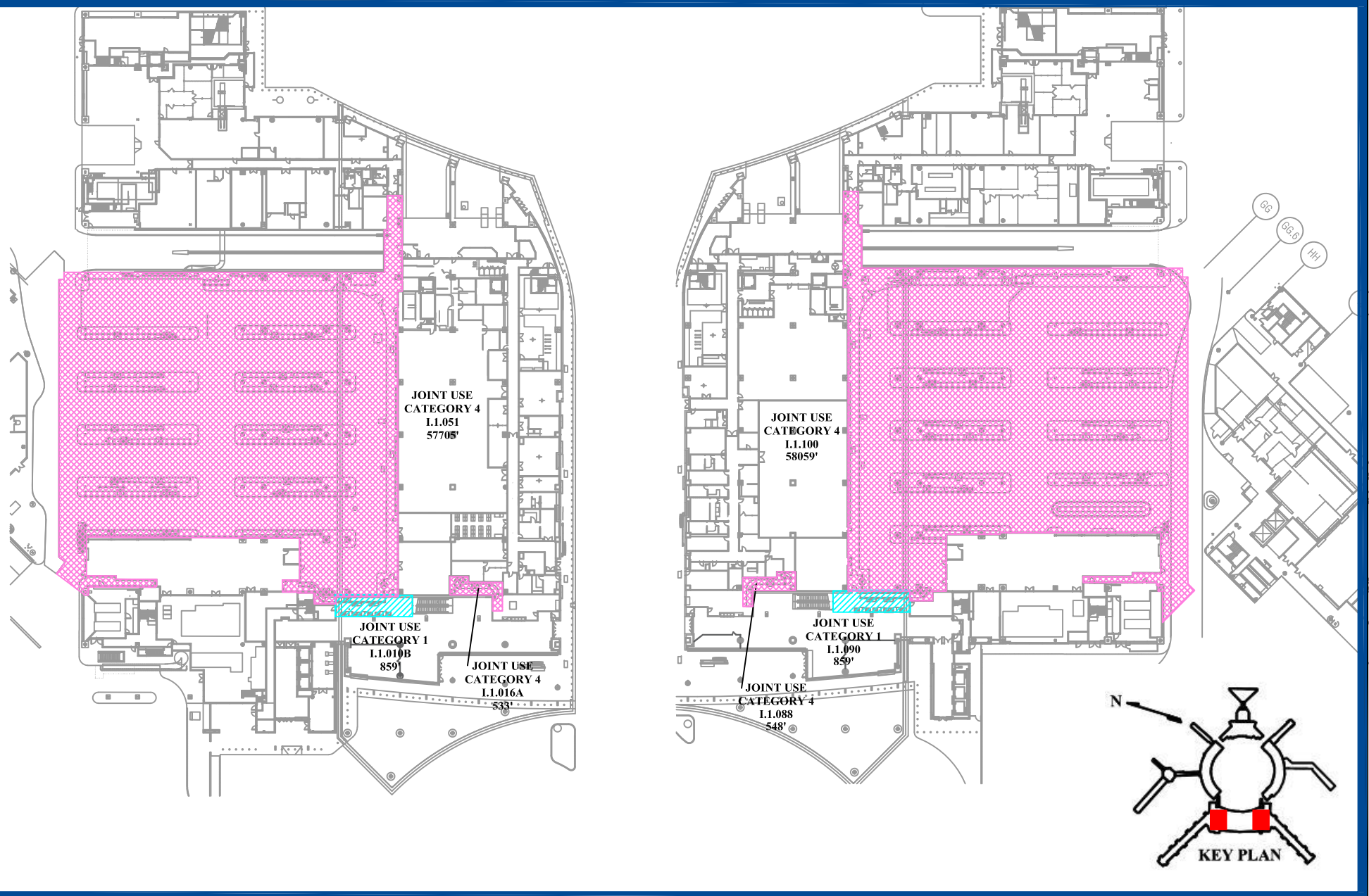

TENANT LOCATION LEASE DRAWING		LOCATION	TENANT	CAT	AREA	CONTRACT	EFF DATE
LOCATION: INTERNATIONAL TERMINAL, 1ST FLOOR			JOINT USE	1	1718'		
JOINT USE			JOINT USE	4	116845'		
CITY & COUNTY OF SAN FRANCISCO	DWG: IT1JT						
AIRPORTS COMMISSION	SCALE: 1"=10'-0"						
SAN FRANCISCO INTERNATIONAL AIRPORT	DATE: 07/01/2023						

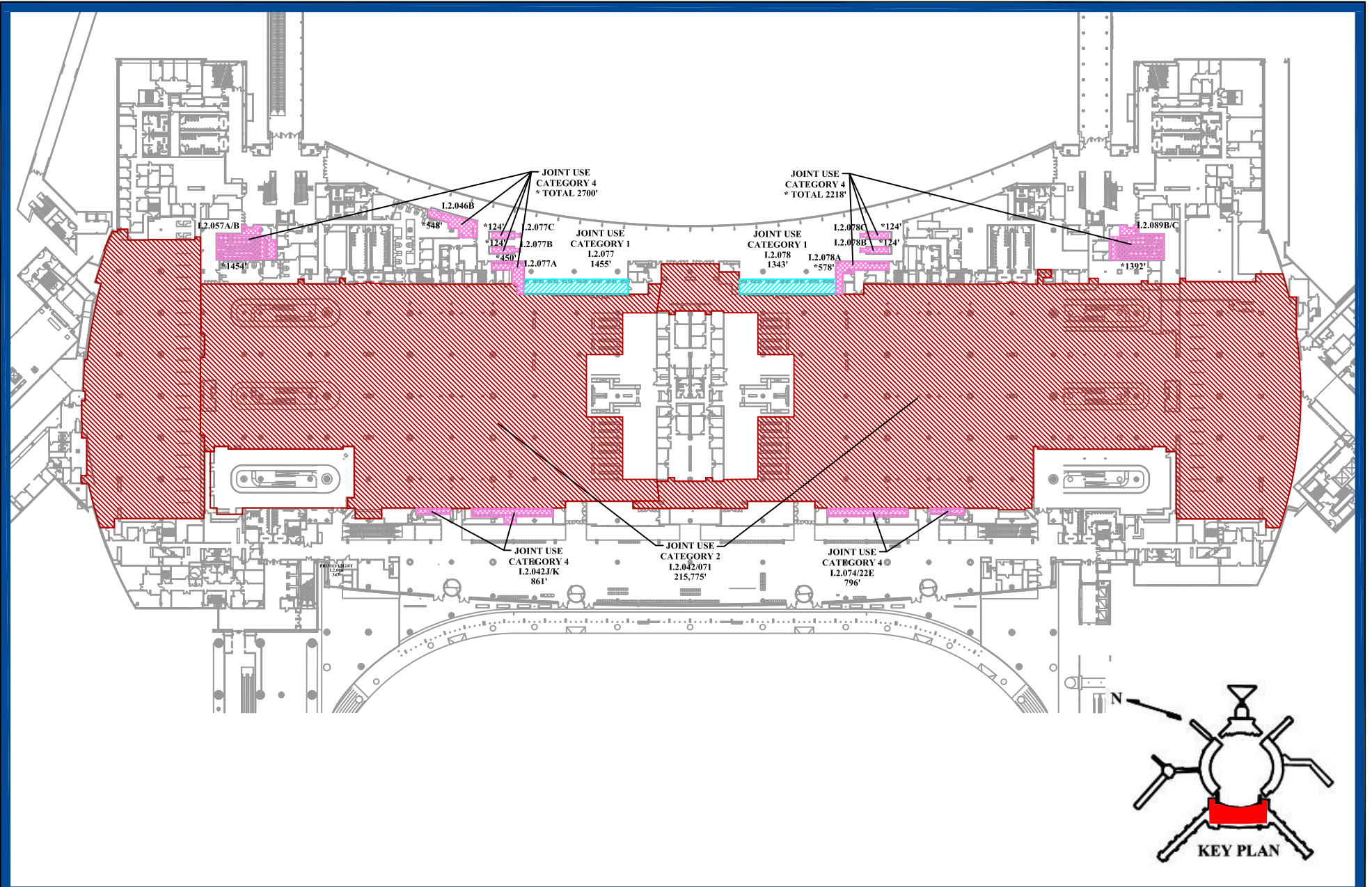

**TENANT LOCATION LEASE DRAWING**

	LOCATION	TENANT	CAT	AREA	CONTRACT	EFF DATE
LOCATION: INTERNATIONAL TERMINAL, 2ND FLOOR, CENTER		JOINT USE	1	2798'		
JOINT USE		JOINT USE	2	215775'		
CITY & COUNTY OF SAN FRANCISCO	DWG: IT2JT	JOINT USE	4	6575'		
AIRPORTS COMMISSION	SCALE: 1"=100.8"					
SAN FRANCISCO INTERNATIONAL AIRPORT	DATE: 07/01/2023					



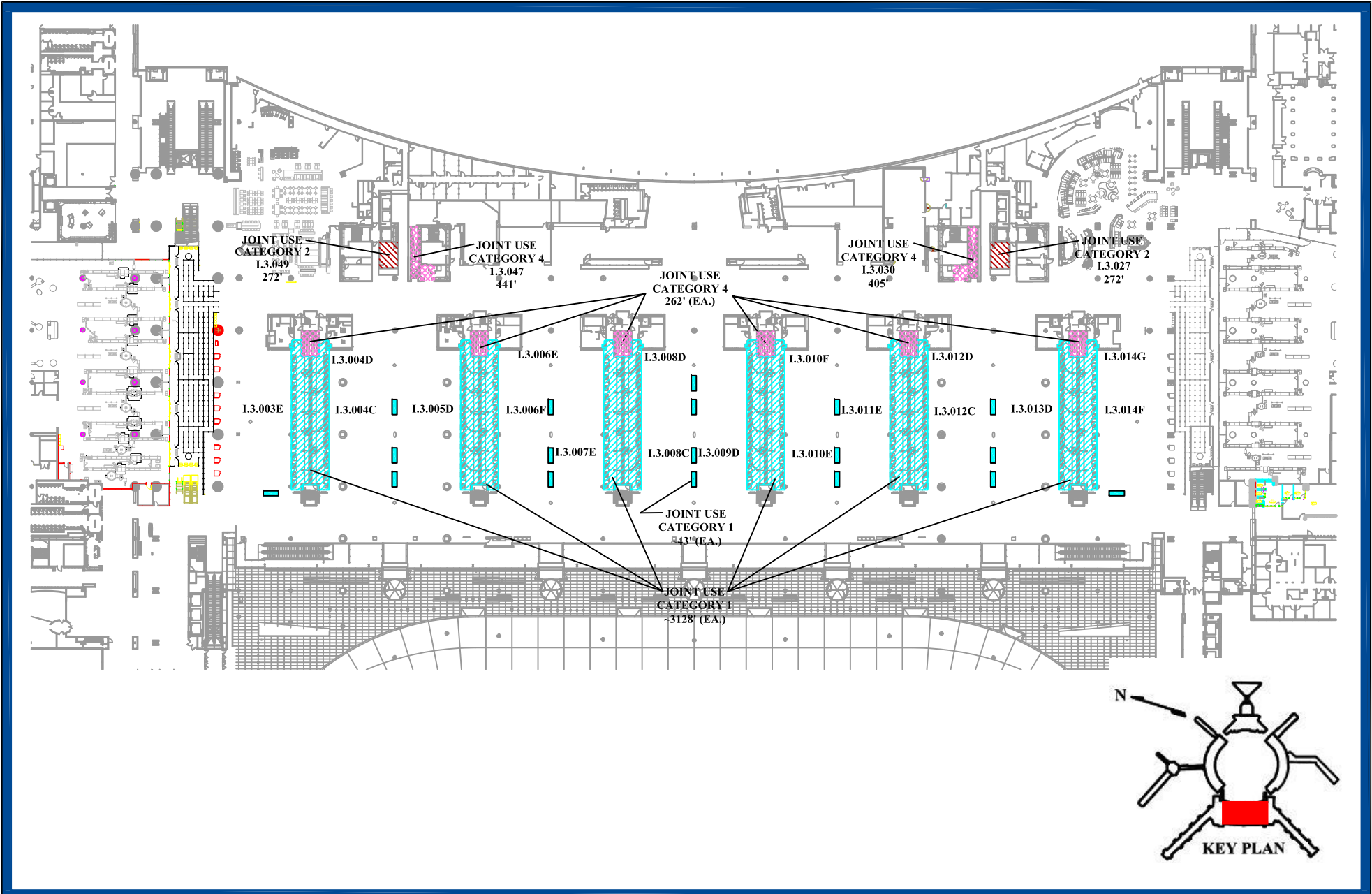

**TENANT LOCATION LEASE DRAWING**

	LOCATION	TENANT	CAT	AREA	CONTRACT	EFF DATE
LOCATION: INTERNATIONAL TERMINAL, 3RD FLOOR CENTER		JOINT USE	1	779'		
JOINT USE		JOINT USE	1	18769'		
CITY & COUNTY OF SAN FRANCISCO	DWG: IT3JT	JOINT USE	2	544'		
AIRPORTS COMMISSION	SCALE: 1/8"=1'-0"	JOINT USE	4	2418'		
SAN FRANCISCO INTERNATIONAL AIRPORT	DATE: 07/01/2023					



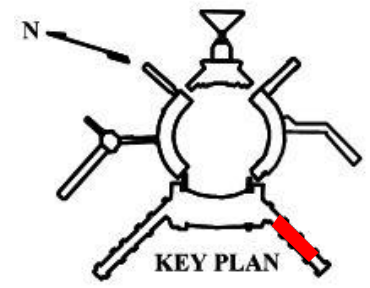
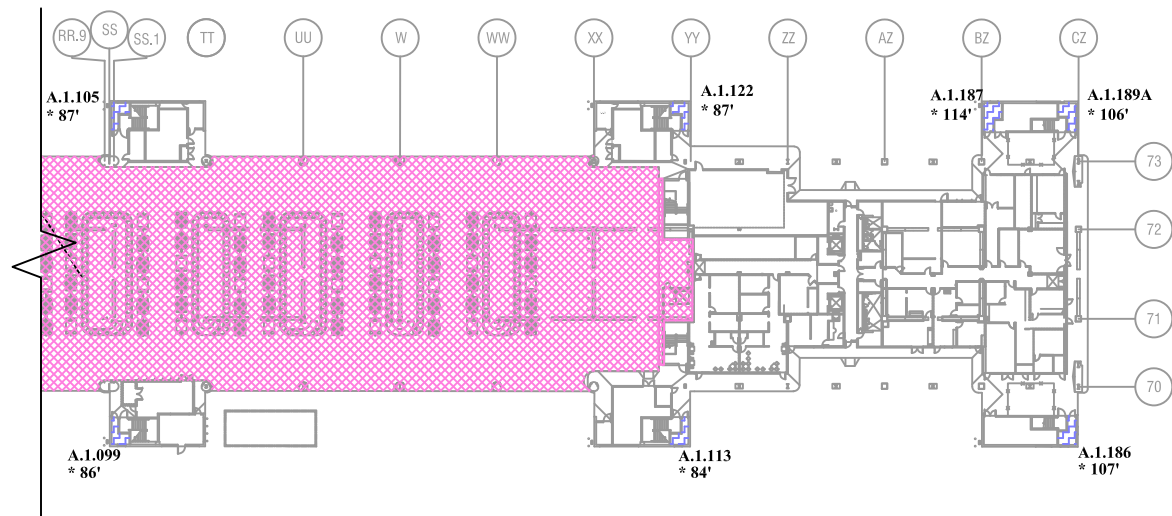
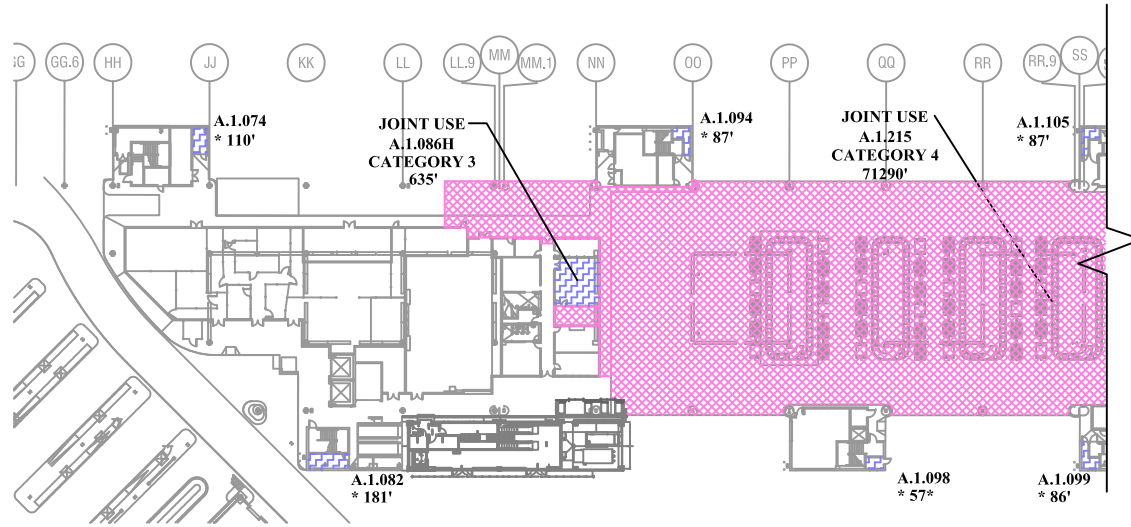

**TENANT LOCATION LEASE DRAWING**

	LOCATION	TENANT	CAT	AREA	CONTRACT	EFF DATE
LOCATION: BOARDING AREA A, 1ST FLOOR		JOINT USE	3	635'		
JOINT USE		JT GATEHSE	3	1106'		
CITY & COUNTY OF SAN FRANCISCO	DWG: BAA1JT	JOINT USE	4	71290'		
AIRPORTS COMMISSION	SCALE: 1"=10'-0"					
SAN FRANCISCO INTERNATIONAL AIRPORT	DATE: 07/01/2023					

I:\AutoCad\LEASE\newitb\aviation\joint\BAA1JT.dwg

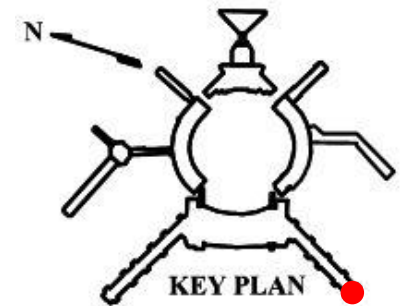
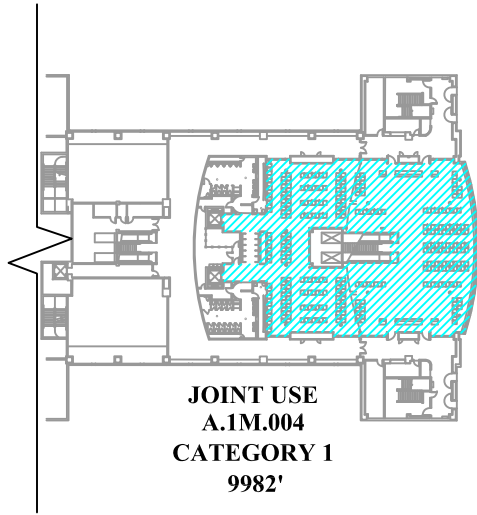
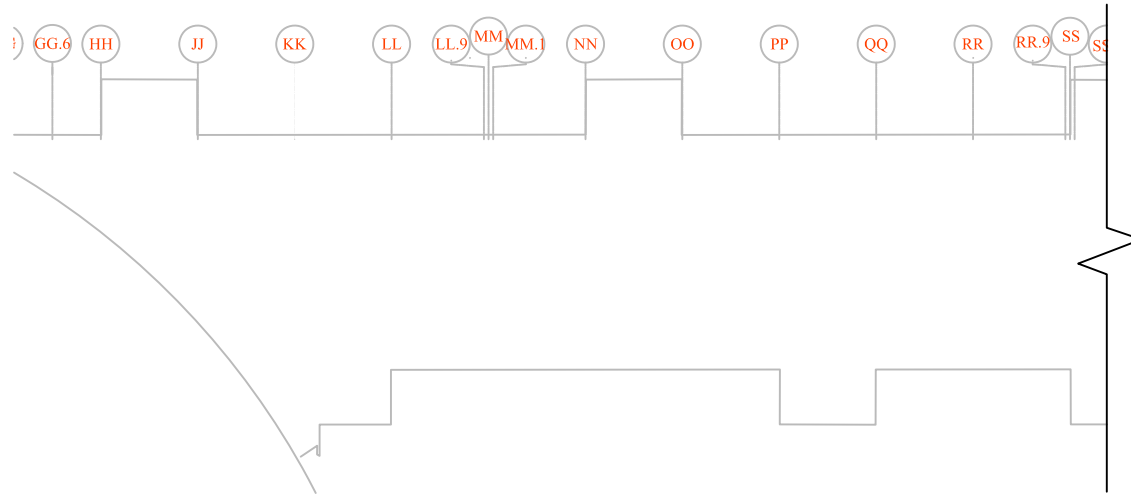

TENANT LOCATION LEASE DRAWING		LOCATION	TENANT	CAT	AREA	CONTRACT	EFF DATE
LOCATION: BOARDING AREA A, 2ND FLOOR MEZZANINE		A.1M.004	JOINT USE	1	9982'		
JOINT USE							
CITY & COUNTY OF SAN FRANCISCO	DWG: BAA1MJT						
AIRPORTS COMMISSION	SCALE: 1"=10'-0"						
SAN FRANCISCO INTERNATIONAL AIRPORT	DATE: 07/01/2023						

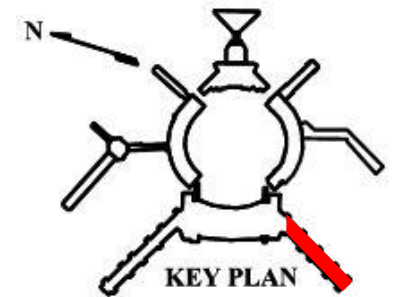
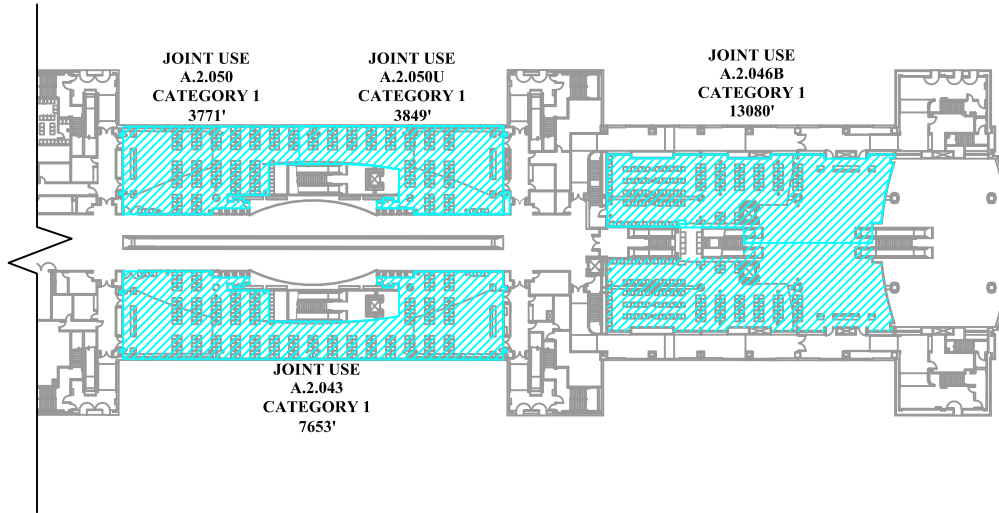
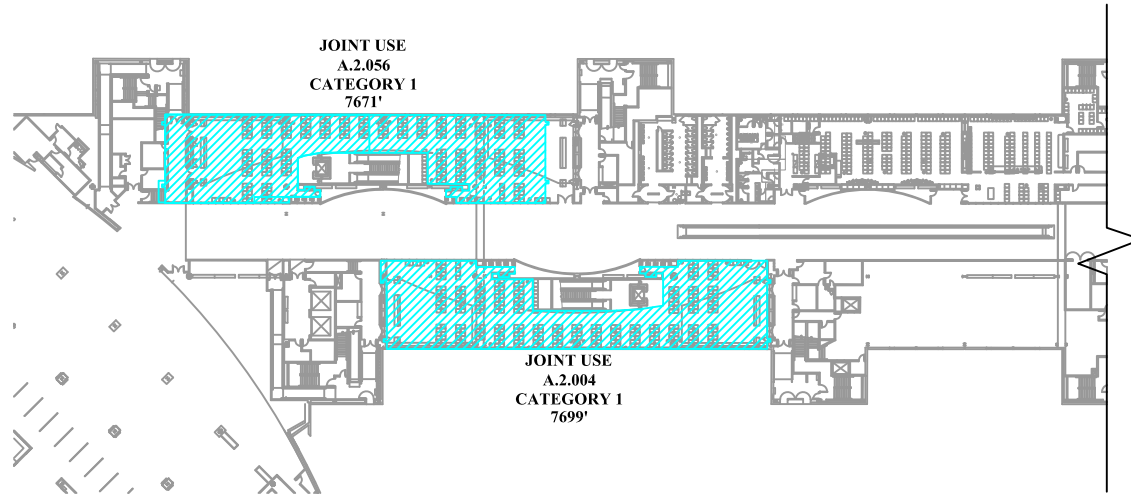

**TENANT LOCATION LEASE DRAWING**

	LOCATION	TENANT	CAT	AREA	CONTRACT	EFF DATE
LOCATION: BOARDING AREA A, 2ND FLOOR		JOINT USE	1	43723'		
JOINT USE						
CITY & COUNTY OF SAN FRANCISCO	DWG: BAA2JT					
AIRPORTS COMMISSION	SCALE: 1/16"=1'-0"					
SAN FRANCISCO INTERNATIONAL AIRPORT	DATE: 07/01/2023					

I:\AutoCad\LEASE\newitb\aviation\joint\BAA2JT.dwg

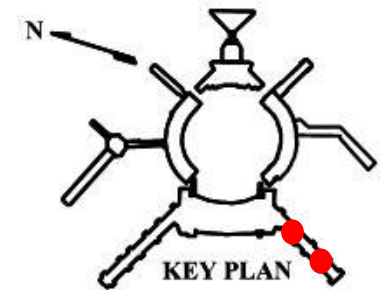
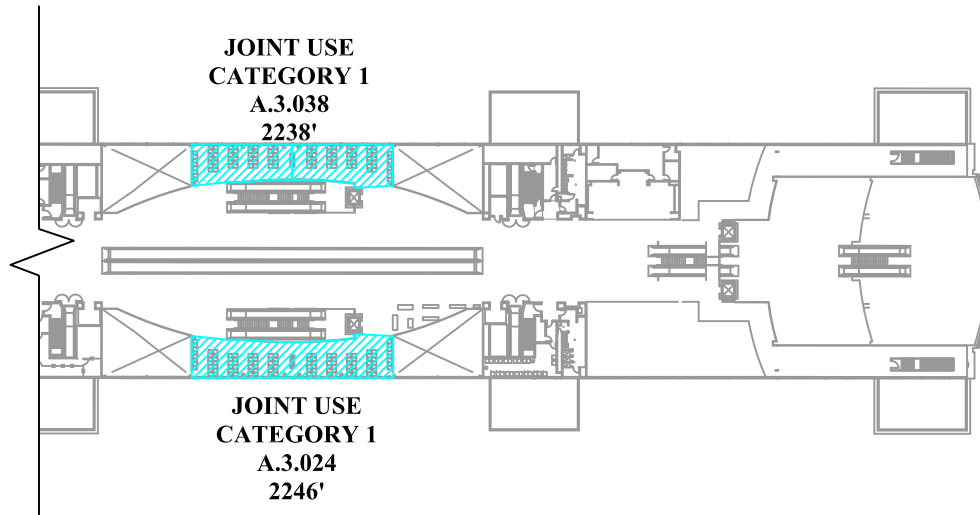
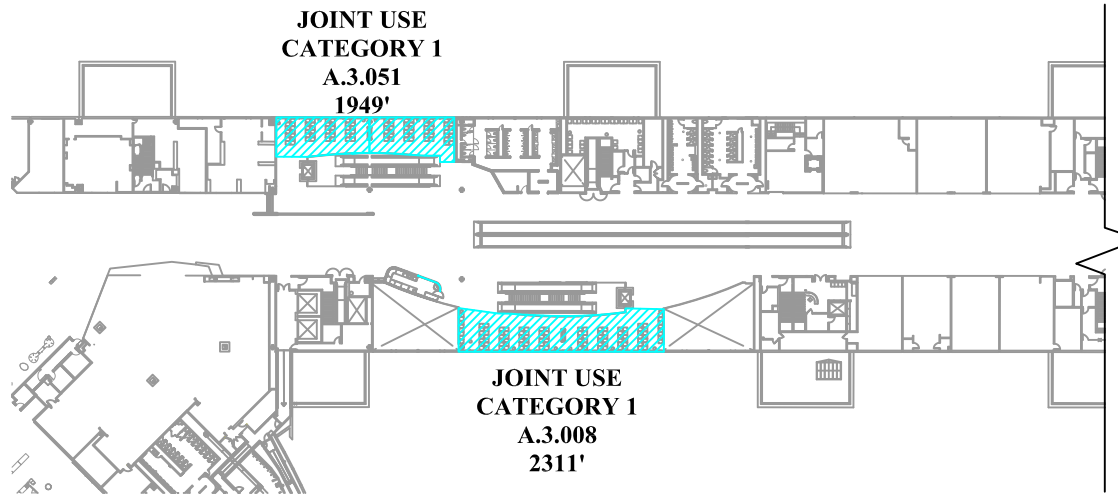

**TENANT LOCATION LEASE DRAWING**

	LOCATION	TENANT	CAT	AREA	CONTRACT	EFF DATE
LOCATION: BOARDING AREA A, 3RD FLOOR		JOINT USE	1	8744'		
JOINT USE						
CITY & COUNTY OF SAN FRANCISCO	DWG: BAA3JT					
AIRPORTS COMMISSION	SCALE: 1/8"=1'-0"					
SAN FRANCISCO INTERNATIONAL AIRPORT	DATE: 07/01/2023					

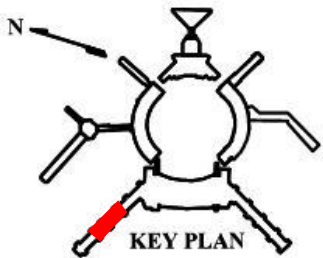
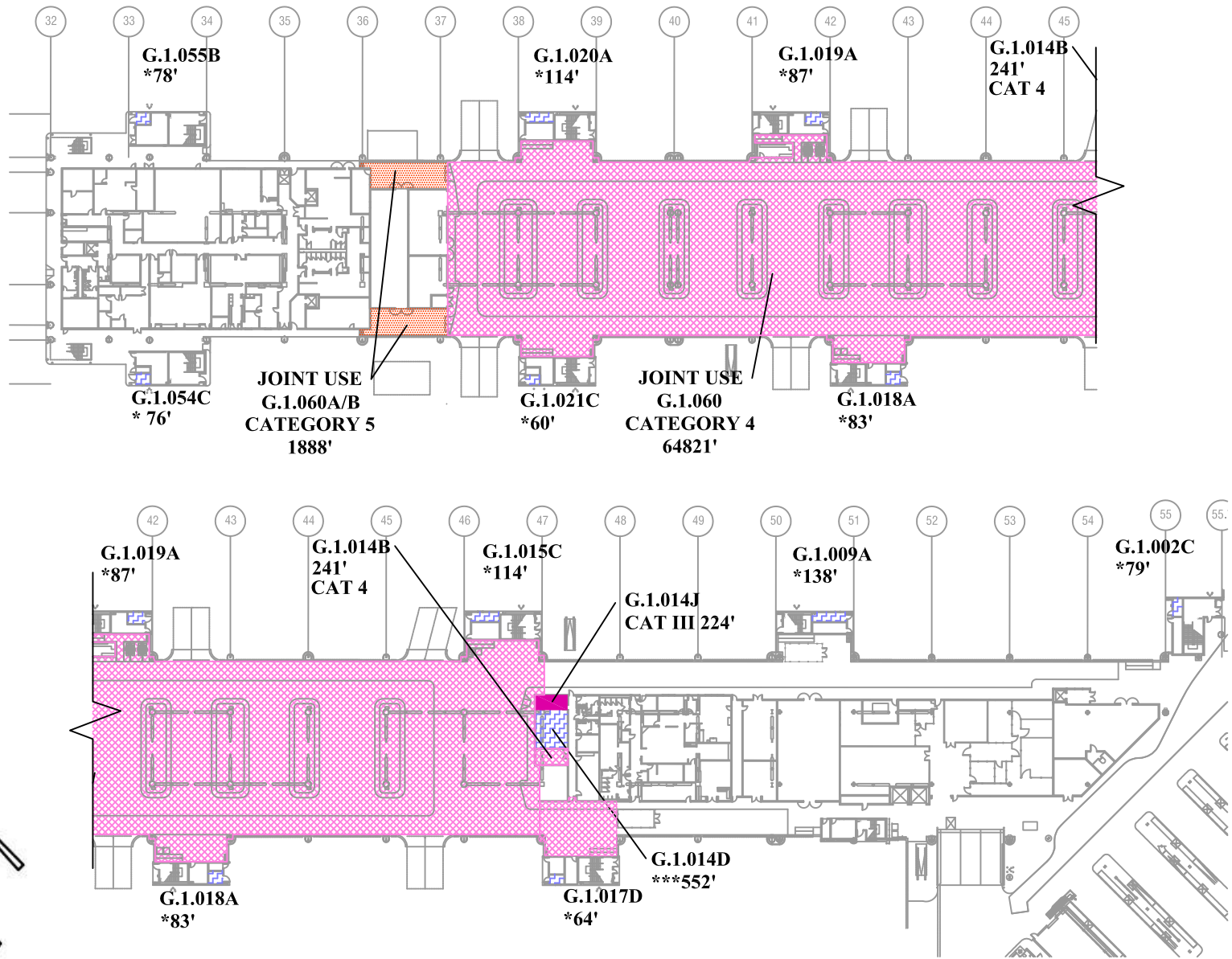

TENANT LOCATION LEASE DRAWING		LOCATION	TENANT	CAT	AREA	CONTRACT	EFF DATE
			JT GATEHOUSE	3	893'		
LOCATION: BOARDING AREA G, 1ST FLOOR			OFFICE	3	776'		
JOINT USE			JOINT USE	4	64821'		
CITY & COUNTY OF SAN FRANCISCO	DWG: BAG1JT		JOINT USE	5	1888'		
AIRPORTS COMMISSION	SCALE: 1"=10'-0"						
SAN FRANCISCO INTERNATIONAL AIRPORT	DATE: 07/01/2023						

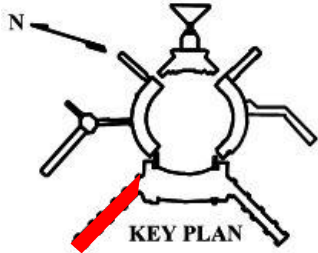
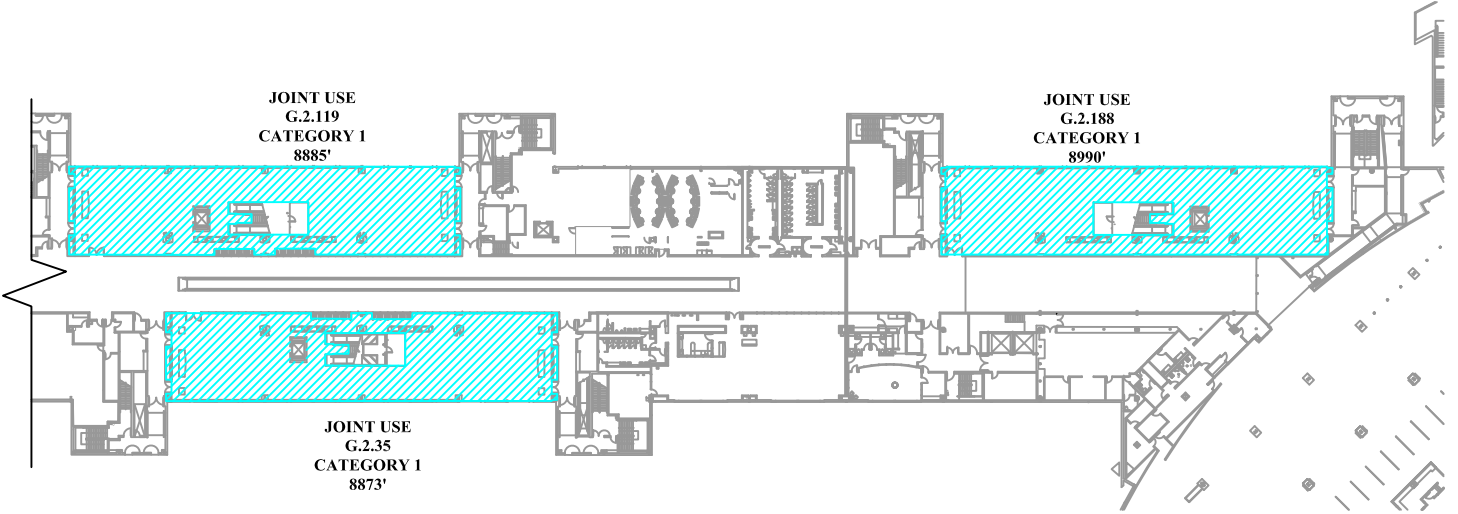
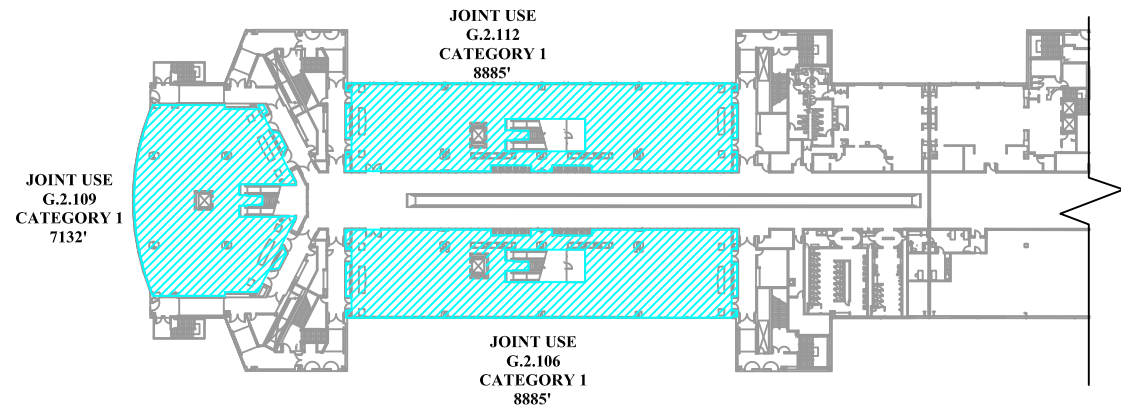

TENANT LOCATION LEASE DRAWING		LOCATION	TENANT	CAT	AREA	CONTRACT	EFF DATE
			JOINT USE	1	51650'		
LOCATION: BOARDING AREA G, 2ND FLOOR							
JOINT USE							
CITY & COUNTY OF SAN FRANCISCO	DWG: BAG2JT						
AIRPORTS COMMISSION	SCALE: 1 <del>NTS</del> "/0"						
SAN FRANCISCO INTERNATIONAL AIRPORT	DATE: 07/01/2023						



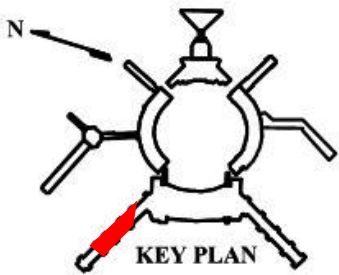
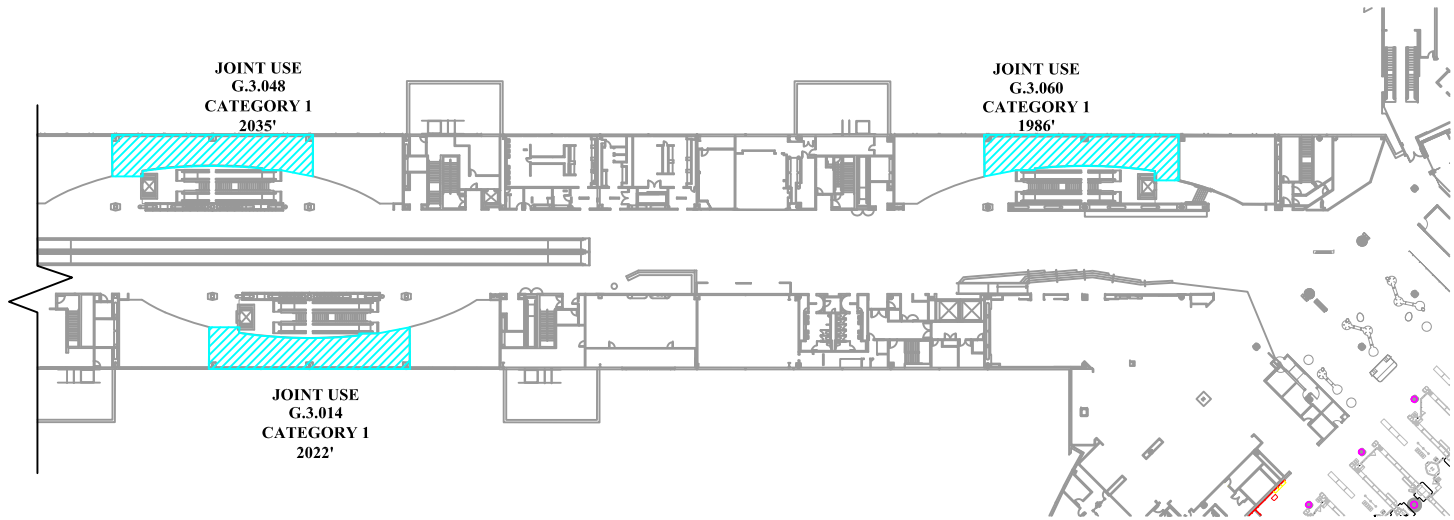
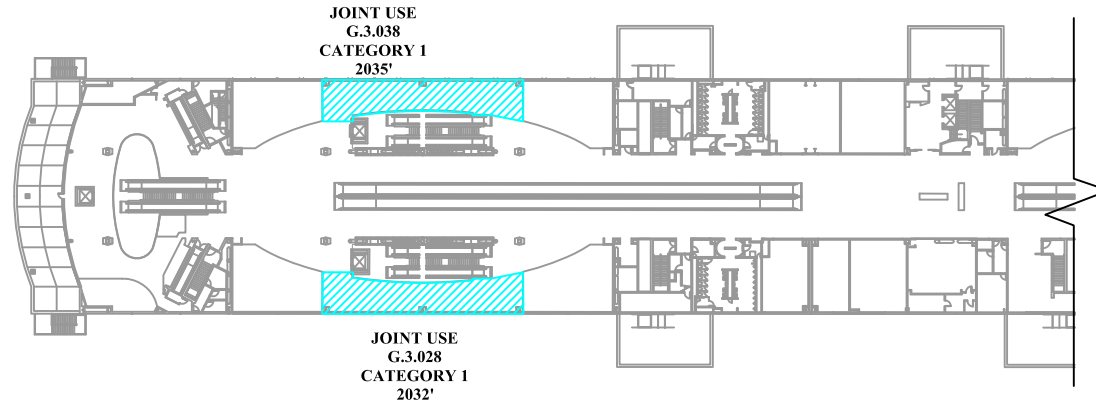

TENANT LOCATION LEASE DRAWING		LOCATION	TENANT	CAT	AREA	CONTRACT	EFF DATE
LOCATION: BOARDING AREA G, 3RD FLOOR			JOINT USE	1	10110'		
JOINT USE							
CITY & COUNTY OF SAN FRANCISCO	DWG: BAG3JT						
AIRPORTS COMMISSION	SCALE: 1 <del>NTS</del> 8'-0"						
SAN FRANCISCO INTERNATIONAL AIRPORT	DATE: 07/01/2023						

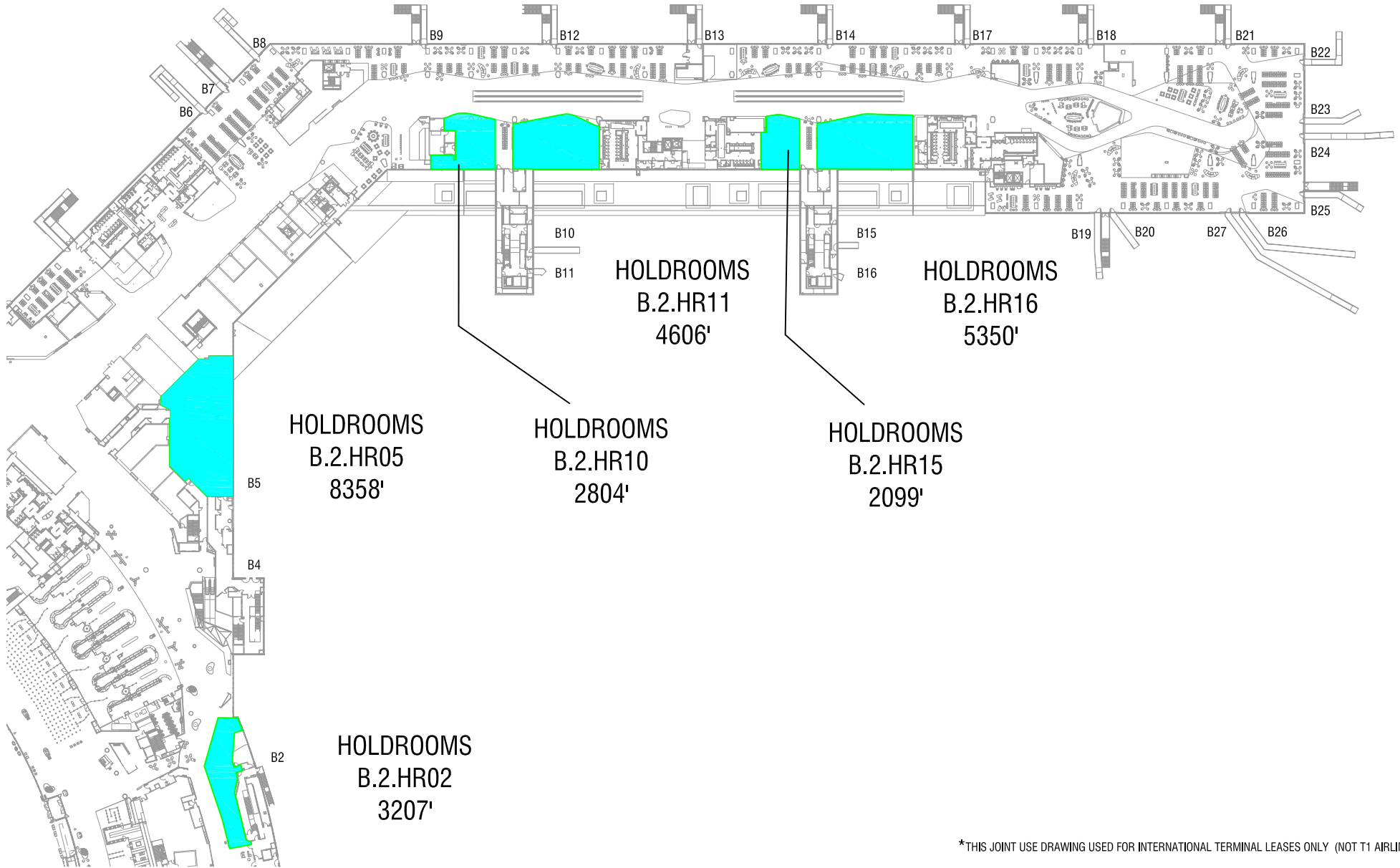

\*THIS JOINT USE DRAWING USED FOR INTERNATIONAL TERMINAL LEASES ONLY (NOT T1 AIRLINES)

# LEASE DRAWING

LOCATION: TERMINAL 1 BOARDING AREA B LEVEL 2

TENANT: JOINT USE

AIRPORT COMMISSION

DWG: T12HOLDROOMS - IT

CITY & COUNTY OF SAN FRANCISCO

DATE: 07/01/2023

SAN FRANCISCO INTERNATIONAL AIRPORT

SCALE: NTS

ROOM NUMBER	AREA	CAT	CONTRACT	EFF. DATE
HOLDROOMS	26424'	I		

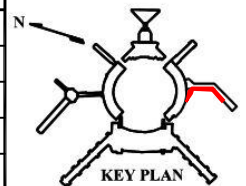

I:\AutoCAD\LEASE\AIR\NET\COMMON\USE\T1\_2\_HOLDROOMS - IT.dwg\_12/14/2022 5:11:40 PM, Adobe PDF



**EXHIBIT E-1**  
**JOINT USE FORMULAS FOR INTERNATIONAL OPERATIONS**

The Joint Use Formulas for International Operations are used to calculate the appropriate charges to be levied on each of the Air Carriers using Joint Use Space for International Operations, which may take place at any Gate in the International Terminal or Swing Gates in the Domestic Terminals. If City authorizes an Air Carrier to operate an International departure from a Domestic Common Use Gate, then these charges will also apply in lieu of any Domestic Operations Fee. For any Air Carriers using Joint Use Space for International Operations which are seasonal (not scheduled year-round), City has the right to exclude such Air Carrier from the Joint Use Formula for International Operations and charge applicable activity-based fees (i.e. per passenger).

For interline turnarounds (e.g., International arrival to Domestic departure), only the International Operation will be charged using the calculations of this Exhibit.

The total charges for each area comprising Joint Use Space (as described in Exhibit D) shall be divided among the Air Carriers using such space and the services related to such use as follows:

- Twenty percent (20%) shall be divided equally among all Air Carriers (excluding Affiliate Airlines) using each such Joint Use Space.
- Eighty percent (80%) shall be divided so that each Air Carrier using the Joint Use Space pays that proportion of said eighty percent (80%) which the number of its passengers enplaning and/or deplaning (as specified below for each category and J/U Type of space) at the IT or any Swing Gates (including its Affiliate Airlines) bears to the total number of enplaning and/or deplaning passengers of those Air Carriers (including their respective Affiliate Airlines) using the Joint Use Space or the related services at the IT or any Swing Gate during the prior Fiscal Year. If for any reason the passengers enplaning or deplaning in the prior Fiscal Year for any of the Air Carriers using the Joint Use Space constitute an inappropriate basis for forecasting that Air Carrier's passenger volume for the year in which the charges are levied, City may make appropriate adjustments in order to equitably apportion the total costs among all of the Air Carriers using such Joint Use Space.
- Subject to the provisions above, the eighty percent (80%) shares for each Space Category and Joint Use type shall be allocated as follows:

<b>Space Category/Joint Use Type</b>	<b>Allocation Basis</b>
I Holdroom/Check-In Counter & Kiosk	International enplaned passengers
II Bag Claim	International deplaned passengers
II FIS	International deplaned passengers requiring use of the FIS
II Other 3 <sup>rd</sup> floor and above, and 1 <sup>st</sup> floor passenger access	International total enplaned and deplaned passengers

<b>Space Category/Joint Use Type</b>	<b>Allocation Basis</b>
III Other Enclosed, 2 <sup>nd</sup> floor and below	International total enplaned and deplaned passengers
IV Inbound Baggage Makeup	International deplaned passengers
IV Outbound Baggage Makeup	International enplaned passengers
V Other Unenclosed	International total enplaned and deplaned passengers

**EXHIBIT E-2**  
**JOINT USE FORMULA FOR DOMESTIC OPERATIONS**

The Joint Use Formulas for Domestic Operations are used to calculate the appropriate charges to be levied on each of the Signatory Airlines leasing Joint Use Space for Domestic Operations, which may take place at any Gate. These formulas exclude the Common Use Domestic Fees which are detailed in Exhibit F and levied on Domestic Operations at any Gate which is not part of the Signatory Airline's allocation of Preferential use Gate or for use of Common Use check-in counters and other resources.

The total charges for each area comprising Joint Use Space (as described in Exhibit D) shall be divided among the Signatory Airlines using such space and the services related to such use as follows:

- Twenty percent (20%) shall be divided equally among all Signatory Airlines (excluding Affiliate Airlines) using such Joint Use Space.
- Eighty percent (80%) shall be divided so that each Signatory Airline using the Joint Use Space pays that proportion of said eighty percent (80%) which the number of its passengers enplaning and/or deplaning (as specified below for each category and J/U Type of space) at the Domestic Terminals (including its Affiliate Airlines) at bears to the total number of enplaning and/or deplaning passengers of those Signatory Airlines (including their respective Affiliate Airlines) using the Joint Use Space or the related services at the Domestic Terminals during the prior Fiscal Year. If for any reason the passengers enplaning or deplaning in the prior Fiscal Year for any of the Signatory Airlines using the Joint Use Space constitute an inappropriate basis for forecasting that Signatory Airline's passenger volume for the year in which the charges are levied, City may make appropriate adjustments in order to equitably apportion the total costs among all of the Signatory Airlines using such Joint Use Space.
- Subject to the provisions above, the eighty percent (80%) shares for each Space Category and Joint Use type shall be allocated as follows:

<b>Space Category/Joint Use Type</b>	<b>Allocation Basis</b>
I Check-In Counter & Kiosk	Domestic enplaned passengers
II Bag Claim	Domestic deplaned passengers
II Other Departures Level and above	Domestic total enplaned and deplaned passengers
III Other Enclosed, Arrivals and below	Domestic total enplaned and deplaned passengers
IV Inbound Baggage Makeup	Domestic deplaned passengers
IV Outbound Baggage Makeup	Domestic enplaned passengers
V Other Unenclosed	Domestic total enplaned and deplaned passengers

**EXHIBIT F**  
**CALCULATION OF COMMON USE DOMESTIC OPERATIONS FEE**

Fees for use of Common Use Gates and facilities for Domestic Operations are currently calculated as set forth below. City reserves the right to modify the calculation methodology and/or add new fees as necessary to accommodate changing circumstances.

For purposes of these calculations, Common Use spaces include all spaces designated as Common Use and any Domestic Joint Use Spaces excluded from the Joint Use Formulas for Domestic Operations as provided in Exhibit D.

These fees exclude extended parking fees which may be levied as provided in the Agreement for parking in excess of the Periods of Use defined for each Operation.

**COMMON USE OPERATIONS**

These fees shall be applied to any Domestic Operations not using a Signatory Airline’s assigned Preferential Use Gates. This shall include all Domestic Operations on Swing Gates, Common Use Gates in the Domestic Terminals, or accommodations of an Air Carrier at another Airline’s Preferential Use Gate.

These fees are calculated on a per Operation basis. Turnarounds will be charged as separate arrival and departure operations. For interline turnarounds (e.g., International arrival to Domestic departure), only the Domestic Operation will be charged using this fee and the International Operation will be charged according to Exhibit E-1.

[A]	Category I square footage rate x Square footage of Common Use hold rooms
[B]	AO&M Expenses – for Common Use loading bridges, ramp area, and hold rooms
[C]	Amortization of the net cost of necessary equipment and finishes, if applicable
The total of [A+B+C] is divided by the average number of Operations. A per departure Operation fee is assessed to the user.	

**COMMON USE BAGGAGE CLAIM FEE**

These fees shall be applied to any Domestic arrivals not using an Airline’s leased Exclusive Use or Joint Use baggage claim system and for any International arrivals not requiring use of the FIS.

[A]	Category II square footage rate x Square footage of Common Use baggage claim area
[B]	50% of AO&M Expenses – for Common Use baggage handling systems
The total of [A+B] is divided by the average number of arrivals. A per arrival fee is assessed to the user.	

## COMMON USE CHECK-IN COUNTERS

These fees shall be applied to any Domestic departures not using an Airline's leased Exclusive Use or Joint Use Check-In Counters

### *Use Charge for Check-In Counter*

- [A] Category I square footage rate  
x Square footage of Common Use Check-In Counters
- [B] AO&M Expenses – for Common Use Check-In Counters and equipment
- [C] Amortization of the net cost of necessary equipment and finishes, if applicable
- [D] Category III square footage rate  
x Square footage of common baggage makeup area
- [E] 50% of AO&M Expenses – for Common Use baggage handling systems.

The total of [A+B+C+D+E] is divided by the average\* number of departures. A check-in counter usage charge is assessed to the user.

**EXHIBIT G**  
**MANAGEMENT PROTOCOLS FOR JOINT USE, COMMON USE,**  
**AND SHARED USE EQUIPMENT**

(1) Purpose

- (a) The Management Protocols for Joint Use, Common Use, and Shared Use Equipment (“Management Protocols” or “Protocols”) provide the framework for the efficient, systematic, and equitable management of the check-in counters and other Joint Use, Common Use and Shared Use Equipment in the Terminals at the Airport, including, but not limited to, the inbound and outbound baggage equipment and systems, the pre-conditioned air and ground power systems, and the passenger loading bridges. These Protocols are developed by the Airport Director in accordance with the Lease and Use Agreement effective on and after July 1, 2023 (the “Agreement”) between the Airport Commission of the City and County of San Francisco and the Signatory Airlines. These Protocols are subject to change by the Director from time to time. All capitalized terms used but not defined in these Protocols have the meanings provided in the Agreement.
- (b) The Protocols deal with the allocation and management of the resources only. Standards, rules, regulations and requirements concerning the use and operation of the equipment and facilities are found in Airport Rules and Regulations, Operations Bulletins and other publications the Airport may issue and revise from time to time.

(2) Scope

- (a) An Air Carrier Consortium may be granted responsibility for managing and allocating day-to-day use of some or all of the check-in counters and other Joint Use, Common Use, and Share Use resources based upon these Protocols. City or any so authorized Air Carrier Consortium may, as it deems necessary, develop, and apply additional policies and procedures to facilitate the proper and effective management of the resources. The protocols should be focused on the assurance of staffing and maintenance to ensure efficient operation of the Terminals and service to the traveling public. Such policies and procedures shall be subject to approval by the Airport Director.

(3) Resource Assignment Responsibilities

- (a) Exclusive Use Resources
  - (i) The Signatory Airlines leasing the resources manages their assignment.
  - (ii) The Signatory Airline may also manage the assignment and use of their lease resources on behalf of others as provided in the Agreement (e.g., handled Air Carriers, Affiliates Airlines, approved sublessees).
- (b) Joint Use, Common Use, and Shared Use Equipment.
  - (i) Certain Check-In Counters and/or other resources may be designated by the Airport Director for Joint Use, Common Use or Shared Use pursuant to the terms of this Agreement.

- (ii) Joint Use, Common Use, and Shared Use Check-In Counters and other resources are established through specific provisions of this Agreement and are not subject to annual allocation.
- (iii) Fees for use of Joint Use, Common Use and Shared Use Equipment are established and assessed by City.
- (iv) City may from time to time establish and adjust minimum quantities in terms of time and/or numbers of Joint Use, Common Use, or Shared Use Check-In Counters or Support Facilities that may be requested.
- (v) Responsibility for management and allocation of Check-In Counters and/or other resources that are designated for Joint Use, Common Use, or Shared Use are managed by City. City may designate certain resources for management by an Air Carrier Consortium on behalf of City.

(4) Management of Non-Exclusive Check-In Counters and Other Resources

(a) Equipment and Facilities Provided.

- (i) Assignment of a Check-In Counter includes the use of the following facilities and equipment associated with that Check-In Counter.
  - (1) Counter or equivalent millwork.
  - (2) Baggage scale.
  - (3) Passenger processing electronics.
    - (a) Equipment sufficient to conduct passenger processing to the current industry standard, as may change with technology available and industry trends.
    - (b) The Air Carrier must provide necessary connectivity to their host system and accomplish any necessary integration of their applications with the platform provided.
    - (c) Should the Airport provide access to a local boarding application (LBA), City may, at its sole discretion, assess an additional fee for Air Carrier's use of this resource.
  - (4) Sign(s) identifying the Air Carrier using the counter and the function being performed at the counter.
  - (5) Baggage handling system (outbound).
  - (6) In-line explosive detection system.
  - (7) Baggage make-up area, including lateral or carousel type make up device(s) serviced by the assigned counter(s).
  - (8) Odd-size baggage capability
    - (a) Capability to transport odd-sized baggage from the counter area to an area accessible to screening and loading processes.
    - (b) No porter service or equipment is provided.

- (ii) SFO may not fully equip each Airport-controlled Common Use Check-In Counter, or group of Common Use Check-In Counters due to forecast demand or other considerations.
    - (1) The association of outbound baggage handling systems and check-in counters may also cause similar conditions to exist at fully equipped counters (e.g., a check-in counter is available, but the associated baggage system is in use by others).
    - (2) Upon the request or agreement of the Air Carrier, these counters may be assigned in their “as is” condition.
    - (3) Some Common Use Check-In Counters may not have a direct connection to the baggage handling system. These Counters will be prioritized for assignment for purposes which do not require baggage acceptance (e.g., irregular operations rebooking, customer service)
  - (iii) Inbound baggage claim devices and associated feed belts may be requested on a per flight or Period of Use basis.
    - (1) Assignment includes right-of-way to all associated feed belts and use of odd-size baggage claim facilities.
    - (2) Porter service is not provided.
  - (iv) Airline must provide data and baggage service messaging (BSM) for BHS.
- (b) Requesting and Allocation of Joint Use, Common Use, and Shared Use Check-In Counters and Other Resources.
- (i) **International Operations**
    - (1) Check-In Counters and other resources requested for processing International Operations are assigned contingent upon requesting Air Carrier being granted operating (Gate) permission through the IATA scheduling process or other processes as may be specified by the Airport Director.
      - (a) If authorized, an Air Carrier Consortium may administer the Gate and subsequent check-in counter and other resources allocation processes on City’s behalf. Related policies and procedures developed by such Air Carrier Consortium or other designated entity to facilitate these processes (with the exception of the IATA Scheduling Guidelines) are subject to approval by City.
    - (2) Approval of a schedule request assumes use of all facilities and equipment necessary to operate a flight unless specific exceptions are agreed to by any Air Carrier Consortium, requesting Air Carrier, and City.
  - (ii) **Domestic Operations**
    - (1) Check-in counters and other resources for processing Domestic Operations are assigned and managed by City.
      - (a) If authorized, an Air Carrier Consortium may administer the check-in counter and other resources allocation processes on City’s behalf. Related



policies and procedures developed by such Air Carrier Consortium or other designated entity to facilitate these processes are subject to approval by City.

- (2) Check-in counters and other resources for processing Domestic Operations are requested and assigned either in conjunction with the use of a Common Use Gate or independent of Gate use.
- (a) When requested in conjunction with a Gate request, either on a recurring or ad hoc basis, the allocations of Common Use Gates, Common Use Check-In Counters, and Common Use Support Facilities is combined, and use of the full complement of Gates and Common Use resources required to handle a flight (turn, originating or terminating) is considered. The Air Carrier indicates on the Gate request form which resources will be required.
- (3) Fees for the use of Common Use Check-In Counters and Common Use Support Facilities will be assessed according to the fees described in Exhibit F.
- (4) Air Carriers may request use of Common Use Check-In Counters and Common Use Support Facilities without requesting use of a Common Use Gate. Priority will be given to requests associated with Gate use.

(iii) **SFO Airport Operations.** SFO Airport Operations may request ad-hoc use of Joint Use, Common Use, or Shared Use Equipment for operations of an emergency nature, VIP or other Airport-involved operations.

(c) Periods of Use.

- (i) In order to maximize utilization of the Check-In Counters and other resources, the following maximum Periods of Use will be applied. Requests for deviation may be granted dependent upon conditions at the time of operation and do not confer a right or expectation that these deviations may be granted on future occasions.

<b>Type of Operation</b>	<b>International Wide body</b>	<b>Domestic Wide body</b>	<b>Narrow Body</b>	<b>Regional/Commuter</b>
Ticket Counter	-4 Hours to +.5 Hours	-3 Hours to +.5 Hours	-2 Hours to +.25 Hours	-1.5 Hours to +.25 Hours
Baggage Make-up	-4.5 Hours to 0:00	-3.5 Hours to 0:00	-2.5 Hours to 0:00	-2.0 Hours to 0:00

<b>Type of Operation</b>	<b>International Wide body</b>	<b>Domestic Wide body</b>	<b>Narrow Body</b>	<b>Regional/Commuter</b>
Baggage Claim	Actual Time of Flight Arrival +60 minutes	Actual Time of Flight Arrival + 60 minutes	Actual Time of Flight Arrival +40 minutes	Actual Time of Flight Arrival +30 minutes

Wide body = Seats  $\geq$  225 and/or ADG IV, V or VI

Narrow body = Seats  $\geq$  100 and  $<$ 225 and/or ADG III

Regional/Commuter Seats  $<$ 100

“-” (minus) refers to prior to scheduled time of departure or arrival

“0:00” refers to scheduled time of departure or arrival

“+” (plus) refers to after scheduled time of departure or arrival

- (ii) City will establish minimum and/or maximum Periods of Use when Check-In Counters and other resources are not used in conjunction with Gate use.
    - (1) City may grant deviations from minimum and/or maximum Periods of Use based upon operational conditions.
  - (iii) Usage will be assigned and measured in 15-minute increments.
  - (iv) Air Carriers must adhere to the established Periods of Use. Failure to do so may result in a fine pursuant to Section 17.7 of the Agreement.
  - (v) Air Carriers are required to advise City, any Air Carrier Consortium or other designated entity of any cancellations or other deviations from scheduled or last-updated Estimated Time of Arrival (ETA) and/or Estimated Time of Departure (ETD) or other factors that may result in changes to their needs, or their ability to adhere to their assigned period of use in a timely manner. Failure to do so may result in a fine pursuant to Section 17.7 of the Agreement.
- (d) Conditions of Use.
- (i) In order to establish and maintain acceptable levels of customer service, City may establish regulations requiring minimum quantities in terms of time of use and/or numbers of Check-In Counters or other resources that must be operated to service a particular flight or group of flights. These quantities will be approved by the Airport Director and may be changed from time to time.
  - (ii) City or any authorized Air Carrier Consortium will be required to provide the required minimum resources for each Air Carrier operation unless specific exceptions are approved by the Airport Director.
  - (iii) To maximize efficient use of resources, City may assign passenger self-service equipment, such as check-in kiosks, to multiple Air Carriers simultaneously.

(e) Resolution of Conflicts.

- (i) Basic priorities to be applied to resolve conflicting requests for use of the Check-In Counters and associated resources are, in descending order:
  - (1) International Operations operating within coordinated flight parameters (time and equipment type) arranged through the IATA scheduling process.
  - (2) International Operations not operating within coordinated flight parameters (time and equipment type) arranged through the IATA scheduling process.
  - (3) Domestic Operations operating within coordinated flight parameters (time and equipment type) arranged through the scheduling process established by City.
  - (4) Domestic Operations not operating within coordinated flight parameters (time and equipment type) arranged through the scheduling process established by City.
- (ii) Levels of priority within the above categories may be established by City or any authorized Air Carrier Consortium, subject to the approval of the Airport Director.
- (iii) Conflicting requests may also be resolved by proportionately modifying the quantity of Check-In Counters and associated resources assigned to all flights if those adjustments do not create an undue burden on other Air Carrier's flight operations, in the opinion of City or the applicable authorized Air Carrier Consortium.

## **EXHIBIT H GATE MANAGEMENT PROTOCOLS**

### **(1) Purpose**

- a. The Gate Management Protocols provide the framework for the efficient, systematic, and equitable management of the Gates and aircraft parking positions at the Airport. These Protocols are developed by the Airport Director in accordance with the Lease and Use Agreement effective on and after July 1, 2023 (the “Agreement”) between the Airport Commission of the City and County of San Francisco and the Signatory Airlines. These Protocols are subject to change by the Director from time to time. All capitalized terms used but not defined in these Protocols have the meanings provided in the Agreement.
- b. The Protocols deal with the allocation and management of the gate resources only. Standards, rules, regulations, and requirements concerning the use and operation of the equipment and facilities are found in Airport Rules and Regulations, Operations Bulletins, and other publications the Airport may issue and revise from time to time.

### **(2) Scope**

- a. SFO Resource Management shall have responsibility for managing and allocating use of all Airport Gates based upon these protocols. SFO Resource Management may, as it deems necessary, develop and apply additional policies and procedures to facilitate the proper and effective management of the Gate resources. The protocols should be focused on the assurance of efficient operation and service to the traveling public. Such policies and procedures shall be subject to approval by the Airport Director.
- b. SFO Resource Management may delegate day-to-day allocation of certain Gates to an authorized Air Carrier Consortium, subject to approval of the Director. In this case, the authorized Air Carrier Consortium shall manage the Gates in accordance with these Gate Management Protocols and any other practices and procedures designated by SFO Resource Management.

### **(3) Gate and Aircraft Parking Assignment Responsibilities**

- a. **Gates**
  - i. **Preferential Use Gates**
    1. The Signatory Airline granted Preferential Use of a Gate (the “Preference Holder”) manages the assignment of flights at that Gate.
    2. Air Carriers with mutual handling agreements and regional or “express/connection” Affiliate Airlines may be considered the

same as the Preference Holder's flights for purposes of managing and assigning Preferential Use Gates.

3. Preferential Use Gates are allocated annually through a process specified in Article 3 of the Agreement. Assignments are effective March 1 of each year.
4. SFO Resource Management may assign Periods of Use at Preferential Use Gates to another Air Carrier for Accommodation if that Air Carrier has requested a Gate from SFO and cannot be accommodated on a Common Use Gate but could be accommodated on the open Preferential Use Gate without impact to the Preference Holder's Periods of Use, through a process specified in Article 3 of the Agreement.

**ii. Common Use Gates**

1. Common Use Gates are assigned and managed by SFO Resource Management.
2. All Swing Gates and all Remote Gates are Common Use.
3. Common Use Domestic Gates are identified by SFO annually as provided by Article 3 of the Agreement. Assignments are effective March 1 of each year.
4. Any Air Carrier may request and use a Common Use Gate.
5. Gates will be assigned based upon times and durations relative to the allocated time and aircraft type as described in Section (4)(b)(i) below.
6. If no Contact Gates are available to service a Common Use request, or upon specific request, then Remote Gates may be allocated.
  - a. Remote Gate assignments must be accepted if no Contact Gates are available to service a Common Use request.
  - b. Transportation resources to and from Remote Gate to the remote aircraft parking position must be available if they are necessary.
  - c. Requesting Airline must provide sufficient staff as well as passenger and aircraft ground equipment to support remote passenger operations, as further set forth in the Airport Rules and Regulations.

**b. Remote Aircraft Parking Positions**

This section applies to all remote aircraft parking positions (i.e., hardstands or Remain Overnight [RON] positions) not subject to long-term leases.

1. All remote aircraft parking positions are assigned and managed by SFO Resource Management.
2. All remote aircraft parking positions are Common Use and are subject to section 3(a)(ii).

#### **(4) Management of Common Use Gates**

##### **a. Equipment and Facilities Provided**

- i. SFO Resource Management will establish and maintain a listing of aircraft types compatible with each Gate.
  1. Aircraft types not listed for a gate shall not be assigned to that gate.
  2. Modifications to, or deviations from, the aircraft/gate compatibility listing must be approved by City.
- ii. Assignment of a Common Use Gate includes the use of the following facilities and equipment associated with that Gate, if installed and functional:
  1. Use of the aircraft parking position approved for the assigned aircraft, as well as surrounding ramp space.
  2. Passenger Loading Bridge(s) for Contact Gates; vertical circulation and shuttle bus transportation (if required) for Remote Gates.
  3. Ground power.
  4. Preconditioned air (PCA).
  5. Potable water servicing capability.
  6. Associated Gate holdroom.
  7. For Common Use turnaround or departure operations, Common Use passenger processing equipment. For Airlines without Preferential Use or Exclusive Use resources, or for Airlines requesting additional processing capacity, this includes Common Use check-in and outbound baggage handling systems.
  8. For Common Use turnaround or arrival operations, by Airlines without Preferential Use or Exclusive Use resources, or for airlines requesting additional processing capacity, Common Use inbound baggage handling systems
  9. Hydrant fueling is available at most Gates, however arrangements must be made directly with the fuel supplier by the Air Carrier/operator.
  10. Automated Visual Docking Guidance System (A-VDGS)
- iii. Common Use Gates may be assigned and used with certain equipment or

facilities unavailable, or equipment may fail during Period(s) of Use.

1. The Air Carrier/operator representative may request assignment to another Gate, if available, at no additional charge. This applies only for Gates where maintenance is provided by the Airport.
  2. The Air Carrier/operator representative may elect to accept/continue use of the Gate with the understanding that obtaining and operating alternative equipment or facilities is their responsibility and at their expense.
- iv. Operators must comply with Airport Rules and Regulations regarding operation of aircraft and aircraft systems on gates.

**b. Periods of Use**

- i. In order to optimize use of Gate resources, the following maximum Periods of Use will be applied:

<b>Customs Type</b>	<b>Type of Operation</b>	<b>Wide body</b>	<b>Narrow body</b>	<b>Regional/ Commuter</b>
<b>International</b>	Arrival	60 minutes	45 minutes	45 minutes
	Departure	75 minutes	60 minutes	45 minutes
	Turnaround	135 minutes	105 minutes	90 minutes
<b>Domestic or Prcleared</b>	Arrival	45 minutes	30 minutes	20 minutes
	Departure*	60 minutes	40 minutes	30 minutes
	Turnaround	80 minutes	50 minutes	40 minutes

Wide body = Seats  $\geq$  225 and/or ADG IV, V or VI

Narrow body = Seats  $\geq$  100 and  $<$  225 and/or ADG III

Regional/Commuter Seats  $<$ 100

\* Domestic or Prcleared departures shall include departures to Canadian airports with U.S. Customs and Border Protection preclearance facilities.

- ii. SFO Resource Management shall apply minimum Gate rest (Gate not occupied by aircraft) periods between consecutive operations at a Gate in order to allow for minor deviations from schedule, aircraft movement off-and on-gate, transition between operators, positioning of equipment, etc. Minimum Gate rest times for Domestic Narrow body or Domestic regional/commuter operations shall be 15 minutes, and the minimum Gate

rest times for all other operations shall be 20 minutes, subject to review and adjustment by SFO Resource Management as needed.

- iii. Air Carriers must adhere to the established Periods of Use. Failure to do so may result in monetary or other penalties as established by SFO Resource Management and approved by the Airport Director.
- iv. Based upon Gate availability and other operational conditions, Periods of Use may be extended solely at the discretion of SFO Resource Management. Depending on duration, deviations from maximum Periods of Use may be subject to the extended parking fees set by the Commission as provided in the Agreement.
- v. Air Carriers are required to advise SFO Resource Management of any cancellations or other deviations from scheduled or last-updated Estimated Time of Arrival (ETA) and/or Estimated Time of Departure (ETD), or other factors that may result in changes to their needs, or their ability to adhere to their assigned period of use in a timely manner. Failure to do so may result in fines under Section 17.7 of the Agreement as established by the SFO Resource Management and approved by the Airport Director.
- vi. Air Carriers will be provided as much advance notice as possible to prepare for moving aircraft on/off Gates but in all cases must adhere to the Periods of Use. Failure to do so may result in a fine or penalty under Section 17.7 of the Agreement.

**c. Conditions of Use**

- i. SFO Resource Management is authorized to manage the Gate resources as necessary to maximize the safety and efficiency of the overall Airport operation and to provide the highest possible level of customer service.
- ii. SFO Resource Management will be responsible for the resolution of conflicting Gate assignments. To the greatest extent possible given operational conditions, Gate assignments will be honored as originally granted.
- iii. Gate requests may include extended parking (remain all-day/remain overnight). Approved extended parking requests are subject to reassignment or cancellation due to Gate availability at time of operation. Extended parking requests may or may not be assigned to the same Gate as the corresponding arrival and/or departure operations. Extended parking fees set by the Commission as provided in the Agreement will apply to extended parking reservations.



## (5) Common Use Reservation Requests

Advance requesting and Gate planning of recurring needs for Common Use Gates allows the Air Carrier(s) to plan their future schedules and operations with assurance that a Gate will be available for them at the time when they need it. It also provides SFO Resource Management with the ability to better pre-plan and optimize Gate utilization to best meet the needs of the traveling public and the Air Carrier(s).

For International operations, Gate requests are based on specific flights in alignment with the IATA schedule coordination process, as may be modified by the FAA and Airport Rules & Regulations. To establish and maintain acceptable levels of customer service, City will, in consultation with an authorized Air Carrier Consortium, if applicable, establish the coordination parameters to be used in the IATA scheduling process used by City to manage Gate reservations for International Operations. City will also designate the IATA Scheduling Coordinator to represent City in the process as defined by IATA's Scheduling Guidelines.

For recurring Domestic reservations, Gate requests are based on specific flights. SFO Resource Management may, in its discretion, accept recurring Domestic requests based on Periods of Use in order to provide operational flexibility for the Air Carrier(s).

For ad hoc reservations, Gate requests are based on specific flights.

### a. Request Types

Common Use reservations are requested and assigned on either a recurring use basis or an ad-hoc flight basis.

- i. **Recurring use** applies to pre-planned use during the same time of day (Period of Use) over a specified period of time (e.g., Mondays, Aug. 4 through Sept. 8, daily Dec. 1 through Jan. 15, etc.). Recurring use reservations are generally requested at least a week, and up to a year, in advance of the operation.
  1. The user may be a Signatory Airline not offered or declining a Preferential Use Gate.
  2. The user may be a seasonal or new entrant Air Carrier at SFO.
  3. The user may be a Signatory Airline with a recurring, pre-planned Gate requirement that cannot be accommodated within the Signatory Airline's Preferential Use Gate(s).
- ii. **Ad hoc use** is a one-time event which may or not be pre-planned and is generally requested with notice ranging from weeks to an immediate need, such as an emergency request. Ad hoc reservations are requested by flight (arrival, departure, turnaround, or extended parking).

1. The user may be a one-time operation, i.e., a charter flight by a resident or itinerant Air Carrier.
2. The user may be a Signatory Airline with an operational necessity due to irregular operations (delays, diversions, etc.) that cannot be accommodated within the Signatory Airline's Preferential Use Gates.
3. SFO Airport Operations may request ad hoc use of a Common Use Gate or remote parking positions for operations of an emergency nature (e.g., medical diversions, etc.), VIP or other Airport-involved operations, or in the event of extreme irregular operations with the potential for significant passenger disservice (e.g., stranded aircraft).

**b. International Requests**

Requests for Gates to serve international flights are assigned contingent upon requesting Air Carrier being granted a runway reservation by FAA, a terminal reservation through the IATA scheduling process, and following other processes as may be specified by the Airport Director.

- i. SFO Resource Management will administer the reservation and subsequent Gate assignment processes. Related policies and procedures developed by the SFO Resource Management to facilitate these processes are subject to approval by the Airport Director and shall generally comport with the IATA Scheduling Guidelines as amended by the FAA.
- ii. Reservation approval assumes use of all facilities and equipment necessary to operate a flight unless specific exceptions are agreed to by City and the requesting Air Carrier.
- iii. After all International Operations are accommodated, including ad hoc operations, Swing Gates not in use for International Operations may be assigned for Domestic requests.

**c. Domestic Requests**

- i. SFO Resource Management will provide the necessary forms and communication channels required to request the use of a Gate. Requestors must use the prescribed forms and communication channels.
- ii. Separate requests must be submitted for each reservation.
- iii. Each request must indicate it is for a use of a Gate and must provide complete information including duration, i.e., start-end dates, day(s) of week required, Period of Use (i.e., start-end times), and aircraft type.

- iv. If the Requesting Air Carrier is assigned Preferential Gates, it must demonstrate a need for recurring reservations by providing a paired flight schedule in SSIM or another format accepted by the Airport and a Gantt chart showing flight operations allocated at Preferential Use Gates.

**d. Interline Requests**

- i. Interline turnarounds (i.e., International arrival to Domestic departure or Domestic arrival to International departure) shall be evaluated as separate operations.
- ii. Subject to availability, SFO Resource Management will attempt to assign interline turnarounds to the same Gate.

**e. Response Times**

- i. SFO Resource Management will respond to requests for a recurring Common Use reservation within the guidelines specified in section (5)(h).
- ii. SFO Resource Management will respond to requests for ad hoc use of a Common Use Gate within twenty-four (24) hours of receipt.
- iii. SFO Resource Management will respond to requests for ad hoc use of a Common Use Gate with immediate need (within one hour) as soon as possible.
- iv. SFO Resource Management will respond to requests for a Common Use reservation with an “approved” or “not approved-reason” notification to the requesting Air Carrier.

**f. Terms of Use**

- i. To manage the Gate resources as necessary to maximize the safety and efficiency of the Airport, approved reservations associated with a single Gate may be required to change to other Common Use Gates. In these cases, SFO Resource Management will communicate the change to the affected Air Carrier(s) as soon as possible and make reasonable efforts to reassign to a nearby Gate.
- ii. Flight operated by Air Carriers with mutual handling agreements and regional or “express/connection” Affiliate Airlines are considered the same as the Reservation holder’s flight.
- iii. Reservations are not transferable between Air Carriers, nor can they be sub-assigned to others.

- iv. Reservations assigned to a single flight are not transferrable to another flight unless:
  - 1. The requesting airline notifies SFO Resource Management; and
  - 2. The new flight will operate during the same Period of Use as the original reservation.
- v. Air Carriers must notify SFO Resource Management as soon as possible if an assigned Gate reservation will not be used. This action vacates the Air Carrier's Period of Use for the day(s) in which the reservations are cancelled, and SFO Resource Management may reassign the affected resources.
- vi. Gate reservations are revocable if not used (i.e., Gate occupied during requested Periods of Use by requested aircraft type/category) a minimum of 80% of the Periods of Use requested during the preceding twenty-eight (28) days. In this case, the reservation will not accrue any historical priority and may be converted to ad hoc status or cancelled.
- vii. Instances where SFO Resource Management determines that Airline's Preferential Use Gate could have been used to operate a flight for its Period of Use shall be considered as non-use of the Gate reservation for purposes of the 80% calculation. Airline may appeal this determination to SFO Resource Management based on grounds of operational necessity (e.g., broken passenger loading bridge).
- viii. Airlines must submit a new request for each ad hoc request.
- ix. Revoked Gate reservations cannot accrue renewal priority. If an Airline wishes to resubmit a request for a revoked reservation, it will be treated as a new request.
- x. Any request may include a specific preferred Gate, range of Gates (e.g., "D15 or D16"), Boarding Area, or no preference. Requests for specific Gates or ranges of Gates will be accommodated only if optimal utilization of Gate resources is not compromised and will not confer to the requesting airline any long-term rights or preferences to operate at specific Gates.
- xi. To optimize use of Gate resources, the maximum Periods of Use defined in section will be applied as defined in section (4)(b). Air Carriers/operators will be notified of planned on/off Gate times as part of the request approval process.

**g. Extended Parking**

Reservation requests may include extended parking time beyond the defined Periods of Use and will be accommodated if Gate availability permits. Extended

parking reservations may also be submitted as separate requests (i.e., “RON-only” requests).

- i. Extended parking requests may be “turnarounds” with extended parking, combinations of live in/out and extended parking, or extended parking only.
- ii. Extended parking requests will be evaluated as separate reservations.
- iii. Approved extended parking requests are subject to reassignment or cancellation due to Gate availability at time of operation.
- iv. For requests associated with arrivals or departures, SFO Resource Management will make a reasonable attempt to maintain the aircraft at the same Gate as either the arrival or departure, or both, if possible. Requests for extended parking may need to be accommodated at other Gates or remote parking positions, if other operations require the use of the Gate.
- v. Extended parking fees set by the Commission as provided in the Agreement will apply to extended parking reservations.

#### **h. Annual Request Process**

Annual reservation requests are valid for one Allocation Year or period thereof or for the duration requested, whichever is shorter. The annual request process is timed to coincide with the Airport-wide reallocation of Preferential Use Gates.

- i. Domestic requests are processed after the annual assignment of Preferential Use Gates is finalized.
- ii. Approximate timeline – actual dates will be established and communicated to the Air Carriers annually.
  1. November 1 – SFO announces preliminary number and location of Common Use Domestic Contact Gates planned for the next year (effective March 1)
  2. December 10 – SFO announcements final number and location of Common Use Domestic Contact Gates (effective March 1)
  3. January 15 – Signatory Airlines deadline to submit notice of rejection of Preferential Use Gates offered.
  4. January 15-February 1 – SFO accepts and processes requests for Common Use reservations (annual request period).
  5. February 1 – SFO announces assignments of Gates and Common Use Gate reservations (annual request period).
  6. March 1 – Annual Gate allocations and annual Gate reservation assignments are effective.

iii. Domestic requests will be considered on-time if they are received by SFO Resource Management on or before 1700 hours local time on the final day of the annual request period. All domestic requests made after 1700 hours will be considered late.

iv. Priority List

SFO Resource Management will use the following priority list when evaluating requests for Common Use Gates:

1. International requests
  2. Domestic and Precleared renewal requests received on-time, if all of the following conditions are met:
    - a. The reservation for which renewal is requested meets the minimum utilization requirements defined in section (5)(f).
    - b. The renewal request is for the same Period of Use (e.g., 1300-1350) +/- fifteen minutes as requested during the preceding year.
    - c. The Gate capability requested (i.e., type(s) of aircraft that can be accommodated) is unchanged from the preceding reservation.
    - d. In the event of a conflict, renewal requests with the longer duration (length of time in years/months/days) of continuous recurring use as defined in section (5)(f) will have priority.
  3. On-time requests by Signatory Airlines not offered Preferential Use Gates.
  4. On-time requests by Signatory Airlines that were offered and accepted Preferential Use Gate(s).
  5. On-time requests by Signatory Airlines that were offered and declined Preferential Use Gate(s).
  6. On-time requests by non-signatory Airlines.
  7. Late requests in order of receipt.
- v. In the event of a conflict, SFO Resource Management, subject to approval by the Airport Director, shall create methods for resolving ties. Factors to be considered may include, but are not limited to:

1. Average seat capacity per operation of the Airline's same-type (e.g., Domestic) operations at SFO
  2. Air Carrier's previous adherence to the Periods of Use and other terms of Gate Reservations
  3. Origin and destination, including but not limited to distance or new market
  4. Operational factors (maintenance, ground time, etc.)
  5. Remaining conflicts will be resolved by a lottery system designed by Airport staff in consultation with the RMAC.
- vi. SFO Resource Management may assign an International departure to a Domestic Gate, subject to Customs & Border Protection approval.

## **(6) Gate Assignments**

### **a. Management of Gate Resources During Daily Operations**

SFO Resource Management shall consider operational and guest service factors in setting daily Gate assignments. These factors include, but are not limited to, consistency with previous assignments, adjacency to Air Carrier's Preferential Use Gates, passenger processing facilities, and operations spaces, adjacency to VIP lounges and other passenger amenities, and operating hours and capacities of security screening checkpoints and the FIS (if applicable).

### **b. Management of Gate Resources During Irregular Operations**

Priorities applied to resolve Gate conflicts which arise due to schedule deviations or irregular operations shall apply in descending order:

- i. Emergency or other priority operation (classified such by the Airport Director or designee).
- ii. International Reservation – within allocated time of use (+/- 15 minutes)
- iii. Ad hoc international flight – on schedule (within +/- 15 minutes).
- iv. International Reservation – outside of allocated Period of Use (> +/- 15 minutes).
- v. Ad hoc international flight – off schedule (> +/- 15 minutes from schedule).
- vi. Recurring Domestic Reservation – within allocated time of use (+/- 15 minutes).

- vii. Ad hoc Domestic flight – on schedule (within +/- 15 minutes).
- viii. Recurring Domestic Reservation – outside of allocated Period of Use (> +/- 15 minutes).
- ix. Ad hoc Domestic flight – off schedule (> +/- 15 minutes from schedule).
- x. Flights on request but no Gate confirmed (unplanned flights).
- xi. Flights or extended parking requests with no passenger impact (not applied to “ferry in-live out” situations where outbound passengers are waiting).



**EXHIBIT I**

**[RESERVED]**

**EXHIBIT J**  
**ILLUSTRATION OF DOMESTIC TERMINALS**  
**PREFERENTIAL USE GATE ASSIGNMENT FORMULA**

Preferential Use Gates will be allocated and offered to each Signatory Airline as provided in Article 3 of the Lease and Use Agreement. Certain rounding conventions apply, which may be found in Article 3.

All Scheduled Seats and departing Scheduled Operations figures include Affiliate Airlines.

An example of the formula worksheet is shown below:

**Eligible Airline Determination**

*Departing Scheduled Operations during Allocation Review Period*

	Oct 2023	Nov 2023	Dec 2023	Jan 2024	Feb 2024	Mar 2024	Apr 2024	May 2024	Jun 2024	Jul 2024	Aug 2024	Sep 2024	Scheduled Departures	Scheduled Departures per Day	Eligible Airline?
Airline A	1,485	Excluded			1,182	1,333	1,259	1,340	1,366	1,383	1,485	1,206	12,039	44	Yes
Airline B	406				340	376	317	403	450	496	496	452	3,736	14	Yes
Airline C	2,467				2,287	2,596	2,504	2,600	2,603	2,739	2,886	2,371	23,053	84	Yes
Airline D	441				406	450	438	453	438	457	455	415	3,953	14	Yes
Airline E	1,358				1,117	1,299	1,285	1,373	1,430	1,539	1,581	1,273	12,255	45	Yes
Airline F	84				62	84	84	117	153	155	162	152	1,053	4	No
Airline G	62				56	62	60	62	60	62	62	59	545	2	No
Airline H	36				16	30	52	61	101	116	117	47	576	2	No
Airline I	8,294				6,974	8,308	8,049	8,216	8,445	8,836	9,707	7,388	74,217	272	Yes
Airline K	1,482				1,068	1,212	1,170	1,194	1,272	1,360	1,380	1,219	11,357	42	Yes
Airline L	54				0	0	6	91	120	120	119	93	603	2	No

**Scheduled Seats Calculation***Scheduled Seats during Allocation Review Period*

	Oct 2023	Nov 2023	Dec 2023	Jan 2024	Feb 2024	Mar 2024	Apr 2024	May 2024	Jun 2024	Jul 2024	Aug 2024	Sep 2024	Scheduled Seats			
Airline A	220,366	Excluded			181,412	205,027	195,081	211,225	215,512	218,223	232,745	202,801	1,882,392			
Airline B	61,830				51,482	57,851	47,539	58,433	69,320	76,722	76,898	66,116	566,191			
Airline C	346,387				316,242	349,233	331,944	346,061	350,963	367,077	396,332	322,871	3,127,110			
Airline D	69,561				64,050	70,992	69,102	71,469	69,102	72,105	71,787	65,700	623,868			
Airline E	218,669				166,628	201,910	204,542	226,846	239,230	259,544	263,845	210,014	1,991,228			
Airline F	Not Eligible				Not Eligible											
Airline G																
Airline H																
Airline I	1,129,440				881,046	1,069,454	1,079,940	1,104,804	1,167,773	1,223,935	1,374,073	127,811	9,158,276			
Airline K	223,734				159,092	183,460	176,078	179,350	191,464	205,072	205,948	183,757	1,707,955			
Airline L	Not Eligible				Not Eligible											
<b>Total</b>																<b>19,057,020</b>

## Gate Allocation Offer Calculation

<b>Preferential Use Gates</b>	66
<b>Common Use Gates</b>	7
<b>Total Allocable Gates</b>	73

	<b>Scheduled Seats Percentage</b>	<b>Unrounded Preferential Use Gate Number</b>	<b>Rounded Preferential Use Gate Number</b>	<b>Fractional</b>	<b>Gates Offered</b>
Airline A	9.9%	6.52	7	0.52 (1)	6
Airline B	3.0%	1.96	2	0.96	2
Airline C	16.4%	10.83	11	0.83	11
Airline D	3.3%	2.16	2	0.16	2
Airline E	10.4%	6.90	7	0.90	7
Airline F	Not Eligible				
Airline G					
Airline H					
Airline I	48.1%	31.72	32	0.72	32
Airline K	9.0%	5.92	6	0.92	6
Airline L	Not Eligible				
<b>Total</b>	<b>100.0%</b>	<b>66.00</b>	<b>67</b>		<b>66</b>

(1) Per Section 3.4(E), Airline A has the lowest fractional without being less than X.5 and is offered one fewer gate.

*This exhibit is intended to illustrate the formula for allocating Preferential Use Gates among Signatory Airlines in accordance with Article 3 of the Agreement. In the event of any conflict between this exhibit and the Agreement, the Agreement shall prevail. The presentation and format of the calculations illustrated on this exhibit is subject to change.*

**EXHIBIT K**  
**RENTS FOR AIRLINE'S DEMISED PREMISES**

<b>Category Rate</b>	<b>Rate Per Square Foot Per Year FY 2022/2023</b>
I	\$327.50
II	\$245.63
III	\$163.75
IV	\$81.88
V	\$32.75

**EXHIBIT L**  
**Form of Space Change Summary Notice**

Statement of change(s) in [IT/T1/T2/T3] Exclusive Use Space leased by \_\_\_\_\_ pursuant to the provisions of Section 21.22 of Lease and Use Agreement No. \_\_\_\_\_  
 Effective Date: \_\_\_\_\_

Type [modify as needed for specific Terminal/space]	CAT	Original Space			Sq. Ft. Change		Space Following Change		
		Exh. D Sheet Nos.	Location	Sq. Footage	Surrendered	Added	Exh. D Sheet Nos.	Location	Sq. Footage
Check-In Counter	I								
Airline Ticket Office (ATO)	II								
Inbound/Outbound Baggage System	II								

**CITY:**  
 CITY AND COUNTY OF SAN FRANCISCO,  
 a municipal corporation,  
 acting by and through its Airport Commission

APPROVED AS TO FORM:  
 DAVID CHIU, City Attorney

**AIRLINE:**

\_\_\_\_\_

a \_\_\_\_\_

\_\_\_\_\_  
 Ivar C. Satero  
 Airport Director

By \_\_\_\_\_  
 Deputy City Attorney

By: \_\_\_\_\_  
 Name: \_\_\_\_\_  
 Title: \_\_\_\_\_

**EXHIBIT M****LIST OF BASELINE ENVIRONMENTAL REPORTS**

<b>REPORT NO.</b>	<b>TITLE</b>	<b>CATEGORY</b>	<b>LOCATION</b>	<b>DATE OF REPORT</b>
10	Task 2 Fuel Hydrant Line Investigation, Boarding Area A, Volume 1	Fuel Line Investigation	Boarding Area A	01-Aug-95
11	Task 2 Fuel Hydrant Line Investigation, Boarding Area A, Volume 2	Fuel Line Investigation	Boarding Area A	01-Aug-95
15	Revised Draft Work Plan and Site Safety Plan for the Phase 1, Task 3 Site Investigations	Site Investigation Work Plan	Boarding Areas A & B	25-Mar-94
16	Summary of Findings Environmental Site Assessment, Boarding Areas A & B	Investigation Report	Boarding Areas A & B	05-May-94
18	Phase 1 Site Assessment Workplan	Site Investigation Work Plan	Boarding Areas A & B	28-Mar-94
20	1996 First Quarter Monitoring Report, Delta Air Lines	Quarterly Monitoring Report	Boarding Areas B & C	10-Apr-96
21	Fuel Hydrant System Investigation: Boarding Area E & Lease Hold Plot 9, Task 2	Fuel Line Investigation	Boarding Area E & Plot 9	15-Jan-96
22	Task 2 North Terminal Fuel Hydrant Line Investigation, Volume 1	Fuel Line Investigation	Boarding Area F North Terminal	01-Oct-95
23	Task 2 North Terminal Fuel Hydrant Line Investigation, Volume 2	Fuel Line Investigation	Boarding Area F North Terminal	01-Oct-95
24	Task 2 North Terminal Fuel Hydrant Line Investigation, Volume 3	Fuel Line Investigation	Boarding Area F North Terminal	01-Oct-95
25	Remedial Concept Plan for the Boarding Area G Site	Site Investigation Work Plan	Boarding Area G	01-Apr-94
26	Boarding Area C to Boarding Area D (Gate 50) Chevron Fuel Hydrant Interconnect Project	Fuel Line Investigation	Boarding Area D, IT	13-Dec-95
81	Task 2 Fuel Transmission Line and Fuel Hydrant Line Investigation, B/A "A" and Plot 1	Fuel Line Investigation	Boarding Area A & Plot 1	01-Oct-95
114	Site Characterization Report- Task 3, Boarding Areas A & B, Volume 1	Investigation Report	Boarding Areas A & B	08-Nov-94
115	Site Characterization Report- Task 3, Boarding Areas A & B, Volume 2	Investigation Report	Boarding Areas A & B	08-Nov-94

REPORT NO.	TITLE	CATEGORY	LOCATION	DATE OF REPORT
266	Soil Vapor Contaminant Assessment Report of Investigation, Gates 68-69, North Terminal, SFIA	Investigation Report	Boarding Area F North Terminal	12-Apr-88
269	Report of Investigation, Soil Vapor Contaminant Assessment, North Terminal, SFIA	Investigation Report	Boarding Area F North Terminal	02-Jun-88
286	Results of the Geophysical Survey of Selected Areas Around Boarding Areas A & B, SFIA (Draft)	Investigation Report	Boarding Areas A & B	17-Mar-94
287	Request for Airport Access Fuel Hydrant Investigation, Delta Airlines, Boarding Area B and C	Fuel Line Investigation	Boarding Areas B & C	01-Jun-95
295	Site Assessment of TWA Gates 26-31	Investigation Report	Boarding Area B, Gates 26-31	01-Apr-94
299	TWA Gate 21 and Cargo/Freight Areas - Quarterly Groundwater Monitoring Program Final Report	Quarterly Monitoring Report	Boarding Area B, TWA Gate 21	01-Sep-92
324	Results of the Geophysical Survey of Selected Areas Around Boarding Areas A & B, SFIA (Final)	Site Investigation Report	Boarding Areas A & B	17-Mar-94
325	1996 Second Quarter Monitoring Report, Delta Airlines, Inc., Boarding Area B and C	Quarterly Monitoring Report	Boarding Areas B & C	18-Jul-96
337	Task 5 - Feasibility Study/Remedial Action Plan, Boarding Areas B and C, SFIA San Francisco, California	Site Investigation Report	Boarding Areas B & C	31-Jan-96
360	Boarding Area "A" Fuel Line Removal and Remediation, Volume 1	Fuel Hydrant Line Investigation	Boarding Area A	01-Dec-96
361	Boarding Area "A" Fuel Line Removal and Remediation, Volume 2	Fuel Hydrant Line Investigation	Boarding Area A	01-Dec-96
362	Boarding Area "A" Fuel Line Removal and Remediation, Volume 3	Fuel Hydrant Line Investigation	Boarding Area A	01-Dec-96
373	1997 First Quarter Monitoring Report, Delta Airlines, Inc., Boarding Area B and C	Quarterly Monitoring Report	Boarding Areas B & C	08-May-97
376	First Quarter 1997, Quarterly Groundwater Monitoring Report, Trans World Airlines, Inc. Boarding Area B	Quarterly Monitoring Report	Boarding Area B	12-Feb-97
399	United Airlines SFIA Boarding Area G, Project Documents & Technical Specifications for Site Remediation Project, Volume 2	Site Investigation Report	Boarding Area G	01-Dec-95



REPORT NO.	TITLE	CATEGORY	LOCATION	DATE OF REPORT
401	Specifications Existing 24" Pipeline Disconnection Boarding Area "A" and "F" and appurtenant work	Project Specifications	Boarding Areas A & F	28-Sep-95
405	Remedial Action Plan for the Boarding Area A site	Remedial Action Plan	Boarding Area A	01-Nov-95
419	Technical Specifications Monitoring Well Drilling, Installation and Development Exhibit 1, Delta Air Lines	Site Investigation Work Plan	Boarding Area B	26-Aug-97
421	Work Plan for Remediation Services-Delta Airlines-Boarding Area B	Site Investigation Work Plan	Boarding Area B	07-Aug-97
434	First Quarter 1995, Groundwater Sampling Results and Four Quarter Summary Boarding Area B-South Terminal	Quarterly Monitoring Report	Boarding Area B	31-May-95
441	Boarding Area "A" Fuel Pipeline Removal Project, Project Documents and Technical Specifications for Pipeline Removal Project	Project Specifications	Boarding Area A	01-Jan-96
443	1996 Fourth Quarter Monitoring Report, Delta Airlines, Inc., Boarding Area B and C	Quarterly Monitoring Report	Boarding Areas B & C	24-Feb-97
447	1996 Third Quarter Monitoring Report, Delta Air Lines, Boarding Areas B and C	Quarterly Monitoring Report	Boarding Areas B & C	04-Nov-96
459	Work Plan for the Site Characterization of United Airlines Gates 58, 84, and 86	Site Investigation Work Plan	Boarding Area F North Terminal	01-Jan-92
464	Second Quarter 1995 Quarterly Groundwater Report for Boarding Area B, South Terminal at SFIA	Quarterly Monitoring Report	Boarding Area B	01-Jun-95
511	1997 Third Quarter Monitoring Report Delta Air Lines, Inc. Boarding Area B SFIA San Mateo County, CA Law Engineering and Environmental. Service., Project	Quarterly Monitoring Report	Boarding Area B	03-Nov-97
547	Boarding Area "A" Hydrant System (AF16) at SFIA	Fuel Hydrant Line Investigation	BAA Hydrant System IT	24-Oct-97
553	Report: Hazardous Materials Survey SFIA, Tunnel 'D'	Site Investigation Report	Boarding Area D	01-Oct-96
565	Third Quarter 1994 Quarterly Groundwater Report for Gates 26-31, South Terminal	Quarterly Monitoring Report	Boarding Area B, Gates 26-31	01-Oct-94
566	Fourth Quarter 1994, Quarterly Groundwater Reports for Gates 26-31 at SFIA	Quarterly Monitoring Report	Boarding Area B, Gates 26-31	01-Jan-95

REPORT NO.	TITLE	CATEGORY	LOCATION	DATE OF REPORT
577	TWA-SFIA Gate 21 Pipeline Leak: Progress Report No. 1	Site Investigation Report	Boarding Area B	12-Apr-90
594	1997 Third Quarter Groundwater Report for Boarding Area B - South Terminal, Plot 3	Quarterly Monitoring Report	Boarding Area B	24-Oct-97
624	California Regional Water Quality Control Board Order No. 95-136, Task 2 Work Plan - Phase 2 Fuel Hydrant System Investigation	Regional Board Correspondence	Boarding Areas E & Plot 9	23-May-96
641	Boarding Area 'G', Phase 1 and Phase 2 Remediation, SFIA, Volume 1	Site Investigation Report	Boarding Area G	01-Nov-97
642	Boarding Area 'G', Phase 1 and Phase 2 Remediation, SFIA, Volume 2	Site Investigation Report	Boarding Area G	01-Nov-97
643	Boarding Area 'G', Phase 1 and Phase 2 Remediation, SFIA, Volume 3	Site Investigation Report	Boarding Area G	01-Nov-97
644	Boarding Area 'G', Phase 1 and Phase 2 Remediation, SFIA, Volume 4	Site Investigation Report	Boarding Area G	01-Nov-97
645	Boarding Area 'G', Phase 1 and Phase 2 Remediation, SFIA, Volume 5	Site Investigation Report	Boarding Area G	01-Nov-97
646	Boarding Area 'G', Phase 1 and Phase 2 Remediation, SFIA, Volume 6	Site Investigation Report	Boarding Area G	01-Nov-97
649	Work Plan for Fuel Pipeline Leak Detection Testing at Boarding Area E and the Air Cargo Facility	Site Investigation Work Plan	Boarding Area E & Plot 9	03-Dec-97
661	Results of Subsurface Investigation at United Airlines Gate 58, 84, and 86, SFIA	Site Investigation Report	Boarding Area F North Terminal	07-Apr-93
710	Analysis of Effects of Hazardous Materials Remediation Plans on Proposed Structures for Boarding Area G, SFIA	Site Investigation Report	Boarding Area G	01-May-95
738	Summary Report: Hazardous Materials Survey, Terminal E and F	Site Investigation Report	Boarding Areas E & F	01-Mar-97
821	Task 2B-Fuel Hydrant Investigation, Delta Boarding Area B & C, Delta Air Lines, Inc.	Site Investigation Report	Boarding Areas B & C	14-Dec-95
824	Fourth Quarter 1995, Quarterly Groundwater Report For Boarding Area B-South Terminal & Cargo/Freight Area-Plot 3	Quarterly Monitoring Report	Boarding Area B	01-Dec-95

REPORT NO.	TITLE	CATEGORY	LOCATION	DATE OF REPORT
872	Request for Proposal for Remediation Services at Boarding Area B	Site Investigation Work Plan	Boarding Area B	25-Feb-97
889	First Phase Results, Delta Air Lines, Task 2B-Fuel Hydrant System Investigation, SFIA	Site Investigation Report	Boarding Areas B & C	01-Nov-95
894	Third Quarter 1995 Quarterly Groundwater Reports for Boarding Area B-South Terminal at SFIA	Quarterly Monitoring Report	Boarding Area B	26-Aug-95
905	Tenant Improvement United Airlines, Aboveground Fuel Tank Removal, Boarding Area G	Site Investigation Report	Boarding Area G	09-Jun-96
906	Workplan Aboveground Fuel Tank Storage Removal	Site Investigation Work Plan	Boarding Area G	01-May-96
938	Remedial Action Plan Addendum, Delta Air Line Remedial Action Plan, Boarding Area B	Remedial Action Plan	Boarding Area B	12-Dec-96
997	Remedial Action Plan, Boarding Area G Fuel Line Removal Project, SFIA	Remedial Action Plan	Boarding Area G	01-Mar-98
999	United Airlines, SFIA, Boarding Area G Fuel Line Removal Project, Project Documents & Specifications	Site Investigation Report	Boarding Area G	01-Mar-98
1021	1997 Fourth Quarter Groundwater Monitoring Report Conducted by Delta Air Lines at Boarding Areas B and C at SFIA	Quarterly Monitoring Report	Boarding Areas B & C	20-Apr-98
1076	Phase 3 - Subsurface Information Report, B/A, B/A B to F Connector (Phase 3), and B/A G	Site Investigation Report	B/A A, B/A B to F, & B/A G	01-Oct-97
1142	Fuel Line Removal at Boarding Area "A"; Airport Storm Drain Installation Project	Site Investigation Report	Boarding Area "A"	12-May-99
1150	Remedial Concept Plan for the Boarding Area "G" Site	Remedial Action Plan	Boarding Area G	01-Apr-95
1153	Letter Report: Remediation Services at Boarding Area B for Delta Air Lines	Site Investigation Report	Boarding Area B	23-Jun-98
1154	Fuel Line Removal and Remediation, Boarding Area G	Site Investigation Report	Boarding Area G	23-Apr-98
1169	Minor Modifications to Soil and Groundwater Remediation Project Being Implemented by Delta Airlines, Inc. at Boarding Area B	Site Investigation Report	Boarding Area B	29-Jun-99

REPORT NO.	TITLE	CATEGORY	LOCATION	DATE OF REPORT
1171	1999 First Quarter Groundwater Monitoring and System Operations Report, Delta Air Line, Inc., Boarding Area B, SFIA	Quarterly Monitoring Report	Boarding Area B	30-Jun-99
1174	Tentative Order for the Adoption of Revised Site Cleanup Requirements at SFIA; Designation of Additional Primary Dischargers	Regional Water Quality Control Board Report	Boarding Area E and Superbay Hangar	09-Jul-99
1180	First Semi-Annual Groundwater Report for Boarding Area B and Plot 3	Quarterly Monitoring Report	Boarding Area B and Plot 3	01-Jul-99
1185	Task 2 Fuel Hydrant Line Investigation, International Terminal Fuel Subcommittee, Boarding Area D - SFIA	Site Investigation Report	Boarding Area D	08-Sep-95
1187	1999 Second Quarter Groundwater Monitoring and System Operations Report, Delta Air Lines, Inc., Boarding Area B, SFIA, Law Engineering and Environmental Project	Quarterly Monitoring Report	Boarding Area B	09-Aug-99
1203	Additional Information Request Re Naming Responsible Parties at the Superbay Hangar and Boarding Area E at SFIA	Site Investigation Report	Boarding Area E and Superbay Hangar	20-Sep-99
1211	Investigation of Diesel Fuel Line American Airlines Baggage Handling Area Boarding Area E	Site Investigation Report	Boarding Area E	01-Apr-99
1230	1998 Third and Fourth Quarter Groundwater Monitoring and Systems Operations Report, Delta Airlines, Boarding Area B, SFIA	Quarterly Monitoring Report	Boarding Area B	30-Jun-99
1239	Letter RE Storm Drain Installation and Concrete Removal in Boarding Area F, Ramp Area	Regional Water Quality Control Board Report	Boarding Area F	28-Oct-99
1253	Fuel Hydrant System Investigation: Boarding Area E, SFIA, Volume 1 of 3 (Text, Tables, Figures)	Site Investigation Report	Boarding Area E	01-Nov-99
1254	Fuel Hydrant System Investigation: Boarding Area E, SFIA, Volume 2 of 3 (Analytical Reports)	Site Investigation Report	Boarding Area E	01-Nov-99
1255	Fuel Hydrant System Investigation: Boarding Area E, SFIA, Volume 3 of 3 (Analytical Reports)	Site Investigation Report	Boarding Area E	01-Nov-99
1257	Naming Responsible Parties at the Superbay Hangar (TWA and United) and Boarding Area E (United) at SFIA (Order No. 99-045)	Regional Water Quality Control Board Report	Boarding Area E and Plot 40	10-Dec-99
1258	Comments on American Airlines November 1, 1999, Submittal to the RWQCB on Plot 40 Superbay Hangar and Boarding Area E	Regional Water Quality Control Board Report	Boarding Area E and Plot 40	10-Dec-99

REPORT NO.	TITLE	CATEGORY	LOCATION	DATE OF REPORT
1260	Request for Additional Information Regarding Naming of Responsible Parties at the Superbay Hangar and Boarding Area E, SFIA	Site Investigation Report	Boarding Area E and Plot 40	20-Sep-99
1261	Task 2 Boarding Area "D" Fuel Hydrant Line Investigation SFIA Volume I	Site Investigation Report	Boarding Area D	01-Dec-99
1262	Task 2 Boarding Area "D" Fuel Hydrant Line Investigation SFIA Volume II (Appendix D - Lab Reports)	Site Investigation Report	Boarding Area D	01-Dec-99
1263	Task 2 Boarding Area "D" Fuel Hydrant Line Investigation SFIA Volume III (Lab Reports)	Site Investigation Report	Boarding Area D	01-Dec-99
1277	Subsurface Investigation in the Vicinity of Gate 56, Boarding Area "D", to Document Extent of Fuel Line Release	Site Investigation Report	Boarding Area D	23-Nov-99
1278	1999 Third Quarter Groundwater Monitoring and System Operations Report, Delta Air Lines, Inc. Boarding Area B	Quarterly Monitoring Report	Boarding Area B	26-Nov-99
1281	Second Semi-Annual 1999 Groundwater Monitoring Report for TWA Boarding Area B - South Terminal and Cargo/Freight Area-Plot 3, SFIA	Quarterly Monitoring Report	Boarding Area B-South Terminal and Plot 3	01-Dec-99
1284	Boarding Area "G" Fuel Line Closure, SFIA, for United Airlines	Site Investigation Report	Boarding Area G	01-Feb-00
1291	Planned Work for Fuel Vault at B/AG Drainage (Response to letter of October 13, 1999)	Site Investigation Work Plan	Boarding Area G	08-Feb-00
1300	Work Plan Remediation Services Expansion, Boarding Area B, SFIA	Site Investigation Work Plan	Boarding Area B	01-Jan-00
1302	Technical Specifications Bioventing Well and Monitoring Point Drilling and Installation, Boarding Area B, SFIA	Site Investigation Report	Boarding Area B	01-Jan-00
1307	Biovent Pilot Test Results for Delta Air Lines, Boarding Area B, SFIA	Site Investigation Report	Boarding Area B	31-Mar-00
1354	2000 First Quarter Groundwater Monitoring and System Operations Report: Delta Airlines, Inc., Boarding Areas B and C	Quarterly Monitoring Report	Boarding Areas B and C	06-Jul-00
1361	Progress Report on Connection of Sanitary Sewer Line at Boarding Area B	Site Investigation Report	Boarding Area B	26-Jul-00

REPORT NO.	TITLE	CATEGORY	LOCATION	DATE OF REPORT
1364	Request for Variance from Tier 1 Cleanup Requirement, Boarding Area D Fuel Hydrant System	Site Investigation Report	Boarding Area D	23-May-00
1367	Revised Work Plan, Soil and Groundwater Investigation, Boarding Area C, Plot 3E, Plot 50 and Pipe No. 11	Site Investigation Work Plan	BAC, Plot 3E, P50, and Pipe No. 11	20-Mar-00
1373	First Semi-Annual 2000 Groundwater Monitoring Report for TWA Boarding Area B-South Terminal and Cargo/Freight Area - Plot 3	Quarterly Monitoring Report	Boarding Areas B & Plot 3	01-Jul-00
1374	Supplemental Phase II Investigation Boarding Area E/Former Pier B, SFIA	Site Investigation Report	Boarding Area E/ Former Pier B	01-Sep-00
1393	2000 Second Quarter Groundwater Monitoring and System Operations Report, Delta Airline, Boarding Areas B and C, SFIA	Quarterly Monitoring Report	Boarding Areas B & C	26-Sep-00
1400	Second Semi-Annual 2000 Groundwater Monitoring Report for TWA at Boarding Area B - South Terminal, SFIA	Quarterly Monitoring Report	Boarding Area B	01-Dec-00
1418	Approval of Proposed Work Plans for Additional Investigation at Boarding Area E, Board Order No. 99-045	Site Investigation Work Plan	Boarding Area E	05-Jun-00
1443	Letter Report, Soil and Groundwater Investigation, Boarding Area C, Plot 3E, and Pipe No. 11, SFIA, for ARCO	Site Investigation Report	BAC, Plot 3E	25-Oct-00
1451	Observation of Fuel Product Sheen in Storm Drain Manhole at Boarding Area D	Site Investigation Report	Boarding Area D	24-May-01
1452	Monitoring Well Cover Specifications, Boarding Area D Remedial Action Plan	Remedial Action Plan	Boarding Area D	17-May-01
1456	Analytical Results of a Water Sample Collected on January 12, 2001 from the Storm Water Wet Well Located in the BAD Underpass	Site Investigation Report	Boarding Area D Underpass	25-Jan-01
1457	Remedial Action Plan Boarding Area "D" and Former Pier "C" Fuel Hydrant Systems, SFIA	Remedial Action Plan	Boarding Area D and Historic Pier C	31-May-01
1460	Storm Water Pollution Prevention Plan SFO Fuel System Expansion: Boarding Area D Transmission Line	Storm Water Pollution Prevention Plan	Boarding Area D	31-May-01
1462	2000 Third Quarter Groundwater Monitoring and System Operations Report, Delta Air Lines, Inc., Boarding Area B	Quarterly Monitoring Report	Boarding Area B	27-Feb-01

REPORT NO.	TITLE	CATEGORY	LOCATION	DATE OF REPORT
1463	2000 Fourth Quarter Groundwater Monitoring and System Operations Report, Delta Airlines, Inc., Boarding Area B	Quarterly Monitoring Report	Boarding Area B	12-Jun-01
1467	Boarding Area D Apron Rehabilitation Demolition Plan	Project Specifications	Boarding Area D	04-Jun-01
1477	Supplemental Phase II Investigation, Boarding Area E / Former Pier B	Site Investigation Report	BAE - Terminal & Gates	08-Sep-00
1479	Work Plan: Boarding Area C Investigation, SFIA	Site Investigation Work Plan	Boarding Area C	30-May-01
1516	Status Report for the Remedial Action Plan	Remedial Action Plan	Boarding Area D	05-Sep-01
1523	Final Subsurface Investigation Workplan Former Pier "D" Fuel Hydrant System	Site Investigation Work Plan	Boarding Area D, Former Pier D Hydrant System	11-Oct-01
1527	Additional Investigation of the Boarding Area 'G' Footprint United Airlines Service Center, Plots 4, 5 & 6	Site Investigation Report	Boarding Area G Footprint, UAL Service Center	01-Apr-96
1541	Remedial Action Plan Boarding Area D and Former Pier C Fuel Hydrant Systems, SFIA	Remedial Action Plan	Boarding Area 'D' - Former Pier 'C'	31-May-01
1572	2001 First Quarter GW Monitoring and System Operations Report, Delta Air Lines, BAB	Quarterly Monitoring Report	BAB	29-Nov-01
1576	1998 First Quarter GW Report for BAB and Plot 3	Quarterly Monitoring Report	BAB	15-May-98
1577	Soil and GW Investigation for Delta Air Lines and Northwest Airlines at BAC	Site Investigation Report	BAC	21-Jan-02
1593	Notice re: Additional Monitoring Wells and Soil Borings by UAL	Site Investigation Report	BAF - Terminal & Gates	18-Apr-02
1596	Boarding Area E Technical Oversight Committee, Interim Remedial Action Plan, Boarding Area E	Site Investigation Report	BAE	28-Sep-01
1597	Report of Results of Product Analyses (age dating) Performed During SFO Boarding Area C Investigation by Delta Air Lines and Northwest Airlines	Site Investigation Report	BAC	04-Mar-02
1627	Interim Remedial Action Program Implementation, Boarding Area E, SFIA	Site Investigation Report	BAE - Terminal & Gates	20-Mar-02

REPORT NO.	TITLE	CATEGORY	LOCATION	DATE OF REPORT
1630	Interim Remedial Action Plan, Boarding Area E	Remedial Action Plan	BAE - Terminal & Gates	28-Sep-01
1632	Work Plan for Remediation Services Expansion, Boarding Area B, Gate 32	Site Investigation Work Plan	B/A B	14-Jun-02
1641	2001 Third Quarter Groundwater Monitoring and System Operations Report	Quarterly Monitoring Report	BAB, BAC	12-Sep-01
1660	Free-Product Removal Feasibility Study and Interim Remedial Action Plan, Boarding Area E		BAE - Terminal & Gates	30-Sep-02
1670	2001 Second Quarter Groundwater Monitoring and System Operations Report, Delta Air Lines, Inc., Boarding Area B, SFIA		BAB, BAC	01-Jul-02
1678	2001 Fourth Quarter groundwater Monitoring and System Operating Report		BAB, BAC	
1687	SFIA United Airlines North Terminal Feasibility Study/Remedial Action Plan		BAF - Terminal & Gates	30-Apr-03
1689	Expansion of Remediation Services at Gate 32, Boarding Area B Delta Air Lines		BAB - Terminal, Gates & Apron	26-Jun-03
1692	Monitoring Well Abandonment Boarding Area D SFIA	Ground Water Monitoring	Boarding Area D	21-Jul-03
1693	Boarding Area F Remedial Action Program Implementation BAF, SFIA	Remedial Action Plan	BAF - Terminal & Gates	16-Jul-03
1694	Health and Safety Plan Remedial Action Program BAF, SFIA		BAF - Terminal & Gates	16-Jul-03
1695	Storm Water Pollution Prevention Plan (SWPPP) Remedial Action Program BAF, SFIA		BAF - Terminal & Gates	16-Jul-03
1699	2002 First Semi-Annual Groundwater Monitoring and System Operations Report Delta Air Lines, Inc., Boarding Area B and C SFIA		BAB, BAC	30-Jun-03
1701	Second Quarter 2003 Ground Water Monitoring Report, Boarding Area F, SFIA		BAF - Terminal & Gates	13-Aug-03
1710	Phase 1 Remedial Action Program Progress Report, BAE, SFIA		BAE - Terminal & Gates	06-Nov-03
1717	2002 Second Semi-Annual Groundwater Monitoring and System Operations Report Delta Air Lines, Inc., Boarding areas B and C		BAB, BAC	08-Dec-03



REPORT NO.	TITLE	CATEGORY	LOCATION	DATE OF REPORT
1722	Boarding Area F - Monitoring Well Installation and 4th Quarter 2003 Groundwater Monitoring Report		Boarding Area F	29-Jan-04
1726	2003 First Semi-Annual Groundwater Monitoring & System Operations Report, Delta Airlines, Boarding Areas B & C		BAB & BAC	20-Apr-04
1728	First Quarter Groundwater Monitoring Report, BAF, SFIA		BAF	16-Apr-04
1733	Final Supplemental Phase II Investigation Report		BAE/Former Pier B	31-Jan-01
1742	Boarding Area D Remedial Action Plan	Remedial Action Plan	Boarding Area D	12-Feb-03
1754	Boarding Area F Remedial Action Program Progress Report # 1	Monitoring Report	Boarding Area F	12-Sep-04
1764	Boarding Area E Phase 2 Interim Remedial Action Plan Progress Report	Remediation /Monitoring Report	Boarding Area E	08-Apr-05
1768	Descaling Operations at Gates 20, 22, and 33, San Francisco International Airport	Remediation	Boarding Area B	03-Dec-04
1769	2004 First Semi-Annual Groundwater Monitoring and System Operations Report - Boarding Areas B & C	Monitoring	Boarding Areas B & C	15-Dec-04
1770	2003 Second Semi-Annual Groundwater Monitoring and System Operations Report - Boarding Areas B & C	Monitoring	Boarding Areas B & C	26-Jul-04
1788	Final Report: Emergency Clean-up, Asbestos Removal & Encapsulation Project, Rotunda A, South Terminal	Asbestos Abatement Report	Boarding Area A	01-Apr-90
1792	Monitoring Well Installation Boarding Area "D"	Investigation	Boarding Area "D"	20-Sep-05
1796	Boarding Area F Remediation Action Program, Progress Report No. 2, San Francisco International Airport	Remediation Report	Boarding Area F	02-Aug-05
1797	PS Trading Inc. Temporary Closure Fuel System, San Francisco International Airport	Closure Report	Boarding Area A - Boarding Area C	11-Aug-05
1799	Descaling Operations at Gates 20, 22, and 33 San Francisco International Airport	Remediation Report	Boarding Area B	03-Dec-04
1811	Boarding Area E Phase 3 Interim Remedial Action Plan Progress Report, San Francisco International Airport	Remedial action Report	Boarding Area E	18-Nov-05
1812	Groundwater Monitoring Report, Boarding Area D, January 2006 Semi-Annual Report	Monitoring Report	Boarding Area D	22-Mar-06

REPORT NO.	TITLE	CATEGORY	LOCATION	DATE OF REPORT
1823	SFO Fuel Hydrant Pit Repairs, Boarding Area G, San Francisco International Airport	Report & Specifications	Boarding Area G	13-Jun-06
1829	Boarding Area F Remediation Action Program, Progress Report No. 3	Remediation Report	Boarding Area F	13-Sep-06
1834	Boarding Area E Work Plan to Investigate Free product in Well MW-1	Investigation Work Plan	Boarding Area E	13-Mar-07
1838	Boarding Area D Monitoring Well Installation, SFO Fuel Company, LLC.	Well Installation	Boarding Area D	08-Mar-05
1843	Boarding Area E Phase 4 Interim Remedial Action Plan 2006 Progress Report	Remedial Action Report	Boarding Area E	22-Dec-06
1844	Boarding Area D October 2006 Semi-Annual Groundwater Monitoring Report	Monitoring Report	Boarding Area D	30-Nov-06
1848	2005 First Semi-Annual Groundwater Monitoring, System Operations, and Soil Vapor Monitoring Report, Boarding Areas B and C	Monitoring Report	Boarding Areas B & C	17-Aug-06
1854	Boarding Area F Workplan for Soil and Ground Water Investigation	Investigation Workplan	B/A F	16-Apr-07
1858	Field Sampling Workplan for Boarding Area A Fuel System Expansion Baseline Soil Investigation	Sampling Workplan	B/A A	30-Apr-07
1860	March 2007 Semi-Annual Groundwater Monitoring Report Boarding Area D, San Francisco International Airport	Monitoring Report	B/A D	22-Jun-07
1865	Boarding Area F Remedial Action Plan, Progress Report #4	Remediation Monitoring Report	Boarding Area F	12-Sep-07
1866	Semi-Annual Groundwater Monitoring Report Boarding Area D, San Francisco International Airport	Monitoring Report	Boarding Area D	05-Dec-07
1868	February 2008 Semi-Annual Groundwater Monitoring Report, Boarding Area D, San Francisco International Airport	Monitoring Report	Boarding Area D	07-May-08
1869	Boarding Area A Baseline Soil Investigation Report	Investigation Report	Boarding Area A	04-Dec-07
1877	Work Plan for Mobile High-Vacuum Extraction, Former TWA Operations Area, Boarding Area B	Remediation Work Plan	Boarding Area B	30-Jul-08
1881	November 2008 Semi-Annual Groundwater Monitoring Report, Boarding Area D	Monitoring Report	Boarding Area D	17-Dec-08
1883	Boarding Area B Remediation Progress Report # 1	Remediation Report	Boarding Area B	13-Feb-09

REPORT NO.	TITLE	CATEGORY	LOCATION	DATE OF REPORT
1886	Boarding Area F Progress Report # 5, United Airlines	Remediation / Monitoring Report	Boarding Area F	28-Jan-09

**EXHIBIT N**  
**Airport Measurement Specifications**

1. Leasable revenue space adjacent to leasable revenue space is measured from the center line of the wall. When wall thickness is indeterminate assume a 6" wall and 3" to center line.
2. Non-revenue space adjacent to non-revenue space is measured from the center line of the wall. When wall thickness is indeterminate assume a 6" wall and 3" to center line.
3. Leasable revenue space sharing a wall with non-revenue space is measured to the inside face of wall on revenue side.
4. Storefronts locations relative to the lease area calculation are established on a case by case basis. This type of Lease line is typically established at the plumb line of a header fascia or floor finish transition to public space. This is used when walls are unclear, otherwise it is typical to measure to the tenant side face of wall or glass, whichever is greatest.
5. All exterior walls are measured to the inside face of wall.
6. If any wall, being measured to, is made up of glass area greater than 50% of wall area, take measurement from face of glass.
7. Structural columns, structural braces and projections necessary to the building are typically included in area calculation for a given space. Exceptions considered are rooms where these intrusions represent a disproportionately large area of the room outside the normal demising walls.
8. Escalators/elevators and stairs within the lease area included in the area calculation of one floor only. Additional levels may be included by agreement.
9. Telephone services, for revenue purposes, are measured by the shelf size or seat size whichever is larger.
10. Mechanical chases are non-revenue, non-leasable spaces.
11. Fire stairs are non-leasable space.

## **EXHIBIT O CALCULATION OF RATES AND CHARGES**

This Exhibit O [Calculation of Rates and Charges] (this “Exhibit”) to the 2023-2033 Lease and Use Agreement (the “Agreement”) provides additional support for the calculation of Airline Rates and Charges described in Articles 4 and 5 of the Agreement. This Exhibit also provides an illustration of the calculations of Terminal Area Rentals and Landing Fees. This Exhibit is for support and illustrative purposes only, and in the event of a conflict between the contents of this Exhibit and the terms and conditions of the Agreement, the terms and conditions of the Agreement shall control.

Capitalized terms not otherwise defined in the Agreement or this Exhibit shall have the meaning given in the Master Bond Documents. Attachment 1 of this Exhibit summarizes expenses and non-airline revenues by Cost Center for FY 2023/24 pro forma figures, which represents the first fiscal year of the Agreement.

### **EXPENSES**

The expenses of the Commission include the following:

1. AO&M Expenses
  - a. All expenses of the Commission incurred for the operation and maintenance of the Airport including, for example, salaries and mandatory fringe benefits, contractual services, materials and supplies, direct services provided by other City departments (e.g., legal and utilities), and the recurrent maintenance expenses referred to as Facilities Maintenance expenses in the budget of the Commission;
  - b. The payment of pension charges and proportionate payments to such compensation and other insurance or outside reserve funds as the Commission may establish or the Board of Supervisors may require with respect to employees of the Commission, as now provided in Section 16.104 of the City Charter; and
  - c. Such other expenses, if any, required to be paid from the Operations and Maintenance Account or to be treated as Operations and Maintenance Expenses under the Master Bond Documents.
2. Equipment and Small Capital Outlay:
  - a. Items of Equipment consisting of assets whose individual cost is more than \$5,000 (or such other threshold amount as used in the Commission’s financial statements) and less than the Charge Trigger Amount, as increased or decreased annually by the Index; and

- b. Small Capital Outlays consisting of assets whose individual cost is more than the Charge Trigger Amount and less than \$5,218,606 (in FY 2021/22 dollars) pursuant to Section 6.1(B), as increased or decreased annually by the Index.  
Debt Service Requirements:
  - c. Amounts required for deposits to the Revenue Bond Account and for deposits and payments to the General Obligation Bond Account and to the General Purpose Account or to funds and accounts hereafter created under the Master Bond Documents to secure Airport Revenue Bonds;
  - d. Amounts required for deposits and payments to funds and accounts created to secure Special Revenue Bonds, but only to the extent payable from Revenues and authorized by the Majority-In-Interest;
  - e. Amounts required to fund or replenish funds in the Contingency Account;
  - f. Amounts, if any, required pursuant to Section 5.5 of the Agreement to ensure compliance with the Rate Covenant.
  - g. Amounts, if any, of rental credits against tenant invoices to reimburse such tenants for their cost to finance improvements to the Airport pursuant to a formal agreement with the Commission.
  - h. Amounts, if any, required to make payments under credit and liquidity facilities, interest rate swaps, investment agreements, and other agreements entered into in connection with Airport debt; and
  - i. Amounts required to pay fees and expenses of bond trustees, fiscal agents, tender agents, remarketing agents and other similar parties in connection with Airport debt.
3. The Annual Service Payment calculated pursuant to Section 5.2(B) and illustrated in Attachment 2.
  4. The Annual ORCIF Deposit calculated pursuant to Section 5.6 and illustrated in Exhibit R to the Agreement.

### **NON-AIRLINE REVENUES**

The Non-Airline Revenues of the Commission are generally classified as follows:

1. Concession Revenues as defined in Article 1 of the Agreement.
2. Revenues from other sales and fees. This generally includes revenues from the sale of electricity, water and sewage resale, fees for security services, Air Train trip fees, telecommunications fees, license and permit fees, itinerant and general aviation landing

fees, non-Signatory Airline landing fee premiums, jet bridge fees, and fixed-base operator aircraft parking and fuel sales.

3. Revenues from all fixed or cost-recovery based rentals. This generally includes revenues from charges for Common Use facilities, reimbursement of custodial fees from any Air Carrier Consortium, rentals from government agencies, rental car facility fees, the BART rental payment, cargo and hangar space and customs fees and rentals; ground lease rentals; fixed base operator hangar rentals; tank farm rentals; and airline support services.
4. Interest income. This generally includes interest earnings from monies on deposit in the Airport Revenue Fund, the various debt service funds, the various debt service reserve funds, the Contingency Account, and interest attributable to loans, if any, to other parties.
5. PFC revenues designated as Revenues. In accordance with the Master Bond Documents, PFC revenues are excluded from Revenues and can only be included if the Commission designates them as Revenues. Non-Airline Revenue includes PFC revenues in a Fiscal Year only to the extent that the Commission designates an amount of PFC revenues as Revenue for such Fiscal Year.

### **RECONCILIATION OF EXPENSES AND NON-AIRLINE REVENUES**

As part of the City's preparation of its annual audited financial statements, the actual amount of expenses and Non-Airline Revenues is used to calculate the actual amount of Airline Rates and Charges required for the Fiscal Year in accordance with Article 5 of the Agreement. The resulting deficit or surplus is recorded as part of that Fiscal Year's financial activity. This reconciliation process is described in Section 5.5 of the Agreement and is illustrated on the following page.

#### **Illustration of Calculation of Deficit (Surplus) – Airline Rates & Charges**

Total Airport Expenses	
AO&M Expense	[A]
Facilities Maintenance	[B]
Equipment and Small Capital Outlay	[C]
Annual Service Payment	[D]
Debt Service	[E]
Total Airport Expenses	[A+B+C+D+E=F]
Less: Revenues from sources other than airline rates & charges	[G]
= Net Revenue Required	[F-G=H]
Actual Airline Rates and Charges collected	[I]
Deficit (Surplus)	[H-I=J]
<i>If J is greater than 0, result is a Deficit; if J is less than 0, result is a surplus</i>	

## **BUDGETARY FORECAST OF EXPENSES AND NON-AIRLINE REVENUES**

Airline Rates and Charges are calculated to be effective on the first day of each Fiscal Year based on the budgetary forecast of expenses and Non-Airline Revenues for the Fiscal Year. In addition to the expenses of the Commission previously described, the budgetary forecast of expenses also includes the deficit (surplus) of prior years' consisting of:

1. The amount of the actual accumulated deficit (or surplus) from prior periods applied pursuant to Section 5.5 of the Agreement; and
2. The estimated current period deficit (or surplus) pursuant to Section 5.5 of the Agreement.

The term "current period" refers to the Fiscal Year preceding the Fiscal Year for which the Airline Rates and Charges are being calculated.



## **ALLOCATION OF EXPENSES AND NON-AIRLINE REVENUES**

Expenses and Non-Airline Revenues of the Commission are allocated to Cost Centers. The Airport has five (5) Direct Cost Centers:

- 1) Airfield Area Center
- 2) Terminal Area Center
- 3) GT and Parking Area Center
- 4) Other Leased Areas Center
- 5) West of Bayshore Area Center.

Total expenses of these five (5) Direct Cost Centers include the re-allocation of the net expenses and Non-Airline Revenues of the following three (3) Indirect Cost Centers:

- 1) AirTrain Area Center
- 2) Access and Roadways Area Center
- 3) Administration Area Center.

Figure 1 on the following page summarizes the Airport's current "Business Group" ("BG") organizational titles and illustrates how Airport Business Group O&M expenses are allocated to cost centers. Note that one or more Business Group organizational titles, and the total number of Business Groups, may change during the term of the Agreement, but the Direct and Indirect Cost Centers will not change.

### **Prior Years Deficits (Surpluses)**

The deficits (surpluses) of prior years are allocated between the Terminal Area and the Airfield Area in proportion to the amount of Terminal Area Rentals and Landing Fees, respectively, to total Airline Rates and Charges.

## **CALCULATION OF AIRLINE RATES AND CHARGES**

Terminal Area Rental Rate(s) and Landing Fee Rates are calculated pursuant to Section 5.2 and Section 5.3 of the Agreement, respectively, using the allocation of expenses and Non-Airline Revenues to Cost Centers as previously described.

**Figure 1. O&M Cost Center Allocation Flow Chart**

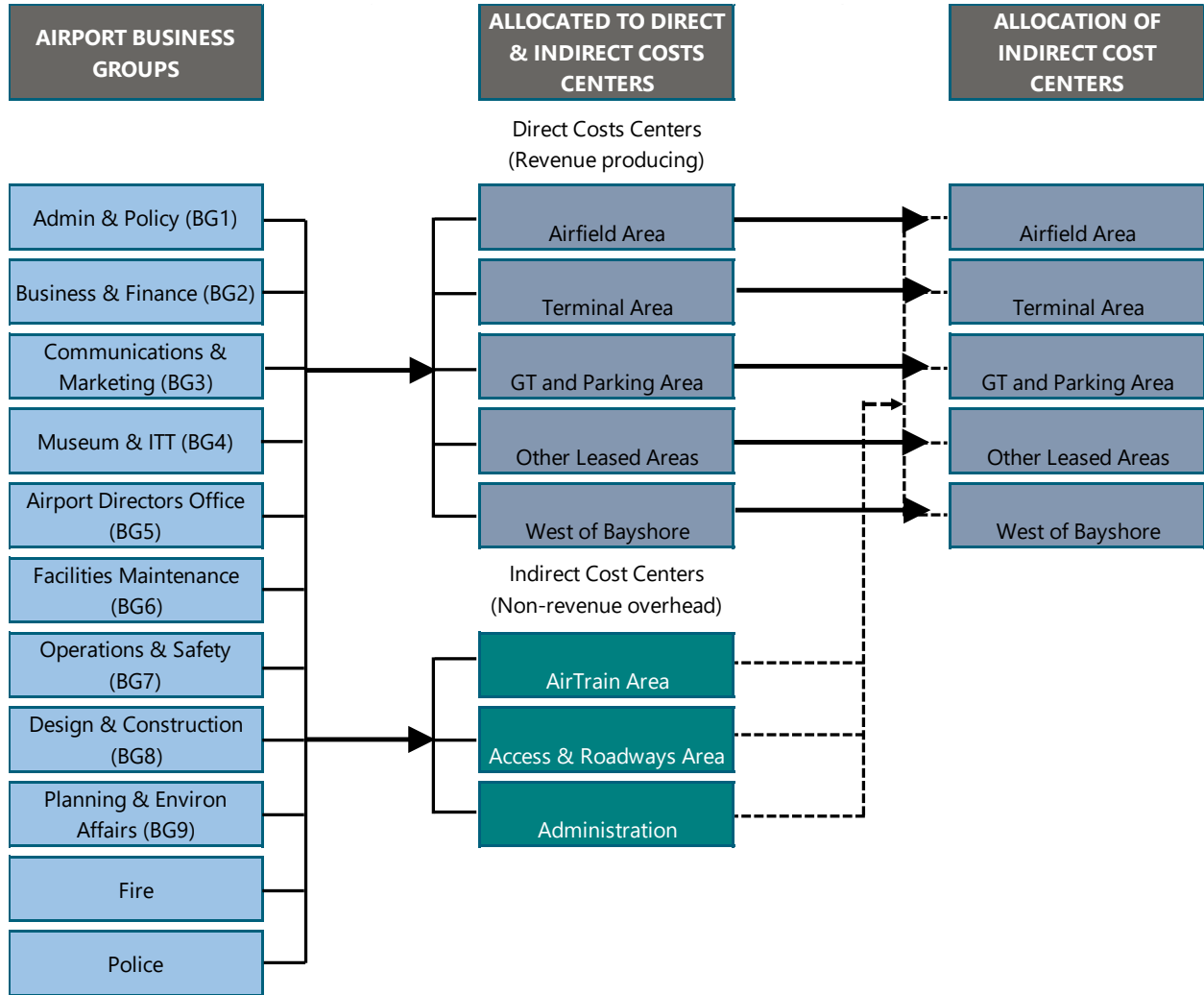

## ILLUSTRATION OF THE AIRLINE RATES AND CHARGES CALCULATION

The calculation of Terminal Area Rental Rate(s) and Landing Fee Rate(s) are depicted on Figure 2. Figure 2 illustrates the basic flow of allocated Expenses and Non-Airline Revenues through the Airline Rates and Charges calculations.

**Terminal Area Rentals.** Attachment 3 provides an illustration of the calculation of Terminal Area Rentals and Rental Surcharge. Terminal Area Rentals are derived by combining (1) the annual “Basic Rentals” and (2) the Terminal Area’s share of either the estimated Rental Surcharge or the “Basic Rental Adjustment.”

“Adjusted Terminal Area Expenses,” the basis for calculating “Basic Rentals,” are derived by combining the following:

1. Direct and Indirect Terminal Area Expenses, plus;
2. Annual Service Payment, plus;
3. Any prior period deficit or surplus in Airline Rates and Charges available for application in the ensuing Fiscal Year.

“Basic Rentals” are calculated by:

1. Adjusted Terminal Area Expenses (as calculated above), divided by;
2. Gross Terminal Space (referred to as the “Basic Rate”), multiplied by;
3. Airline Leased Space adjusted for International Joint Use Space for Swing Contact Gate holdrooms and the Transborder Program.

The Rental Surcharge (or the Basic Rental Adjustment) is computed by:

1. “Basic Rate” multiplied by;
2. Public Space in the terminal including adjustments for Swing Contact Gate holdrooms and the Transborder Program; less
3. Terminal Area revenues from sources other than “Basic Rentals”, plus;
4. Net expenses in the Ground Transportation and Parking Area.

If the cost of the items above exceeds the revenues, then a Rental Surcharge will result. One-half of this Rental Surcharge will be recoverable through Terminal Area Rentals as a Terminal Area Rental Surcharge and one-half will be recoverable through Landing Fees and a Landing Fee Surcharge.

If the revenues of the items above exceed the cost, then a “Basic Rental Adjustment” will result. All of the Basic Rental Adjustment will be used to reduce the “Basic Rentals” of the Terminal Area.

The resulting Terminal Area Rentals will be converted to Terminal Rental Rate(s) for each Space Category as described below and as illustrated in Attachment 4 of this Exhibit.

1. Total Airline Leased Space by the five (5) Space Categories of space (set forth in Section 5.2(D) of the Agreement), multiplied by;
2. The relative value of each Space Category to determine the weighted equivalent square footage of each category;
3. The total weighted equivalent square footage (sum of weighted equivalent square footage for each Space Category) divided by the Terminal Area Rentals results in the “Category I” Terminal Area Rental Rate;
4. “Category I” rate multiplied by the relative value for Categories II, III, IV and V determines the Terminal Area Rental Rates for each of the remaining Space Categories.

**Landing Fees.** Attachment 5 provides an illustration of how Landing Fees and the Landing Fee Rate is calculated. Landing Fees are derived by combining “Basic Landing Fees” and the “Landing Fee Surcharge.”

“Basic Landing Fee” is derived, as follows:

1. Direct and Indirect Airfield Area expenses, less;
2. Non-Airline Revenues from the Airfield Area, less;
3. Residual amount of Non-Airline Revenues minus Expenses from the Other Leased Areas Area and West of Bayshore Area, less;
4. Prior period deficit or surplus, respectively (referred to as “Airfield Area Net Expense”), divided by;
5. Signatory Airline landed weight in 1,000 pound-units (referred to as the “Basic Landing Fee Rate.”)

The “Landing Fee Surcharge,” is derived as follows:

1. One-half of the Rental Surcharge, if any, offset by any net revenues from the Ground Transportation and Parking Area, divided by;
2. Signatory Airline landed weight in 1,000 pound-units.

The “Basic Landing Fee” plus the “Landing Fee Surcharge” becomes the effective Landing Fee Rate payable for the ensuing Fiscal Year.

**Figure 2. Illustration of Rate Setting Methodology**

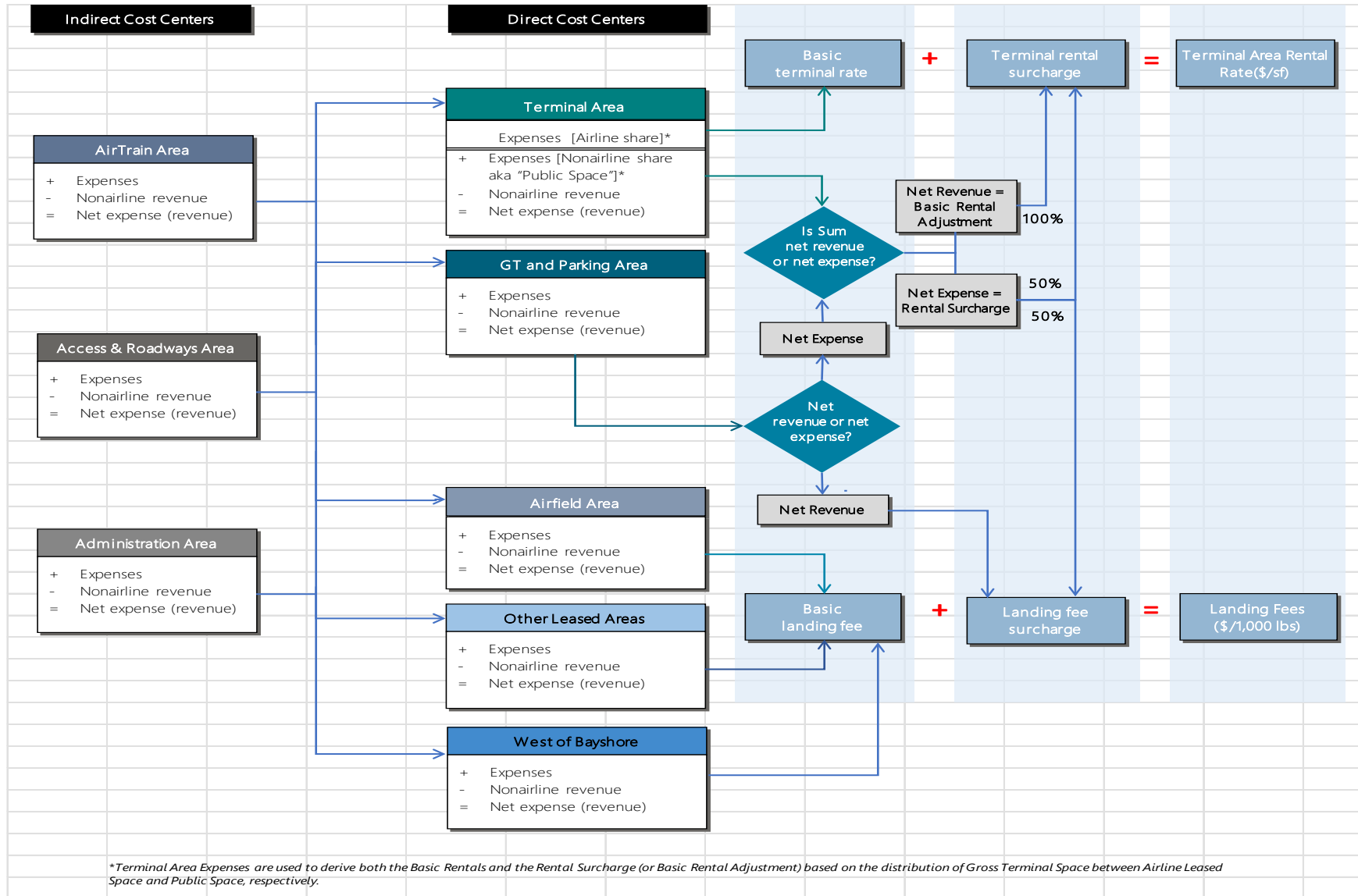

**Attachment 1****CALCULATION OF NET EXPENSE (REVENUE) BY COST CENTER****SAN FRANCISCO INTERNATIONAL AIRPORT**

Pro Forma Fiscal Year 2023/24

(in thousands)

	COST CENTERS				
	Airfield Area	Other Leased Areas	Terminal Area	GT and Parking Area	West of Bayshore Area
<b><u>Non-Airline Revenue</u></b>					
Non-Airline Revenue	\$4,616	\$106,230	\$175,077	\$249,279	\$19
PFCs Classified as Revenues	1,000	-	150,000	-	-
[A]	\$5,616	\$106,230	\$325,077	\$249,279	\$19
<b><u>Expenses</u></b>					
Operation and Maintenance Expenses	\$105,388	\$66,700	\$390,267	\$140,573	\$1,796
Debt Service	43,403	41,728	453,436	54,876	105
Small Capital Outlays	460	479	2,699	1,167	570
Equipment	671	438	1,185	615	19
Annual Service Payment			45,773		
Annual Deposit to ORCIF	53,156		196,844		
[B]	\$ 203,077	\$ 109,345	\$ 1,090,204	\$ 197,231	\$ 2,490
Net revenue (expense)	[A-B] \$ (197,461)	\$ (3,115)	\$ (765,128)	\$ 52,048	\$ (2,471)

Note: Amounts may not add due to rounding.

**Attachment 2****CALCULATION OF ANNUAL SERVICE PAYMENT****SAN FRANCISCO INTERNATIONAL AIRPORT**

Fiscal Year 2023/24

(in thousands)

	Pro Forma 2024
<b><u>Concession Revenues</u></b>	
<b><u>Terminal</u></b>	
Gifts, merchandise, and services	\$43,448
Food & Beverage	25,587
Duty free, in-bond	29,086
Nonairline space rentals	4,251
Total Terminal	\$102,372
<b><u>Ground Transportation and Parking</u></b>	
Auto parking - Public	\$97,834
Car Rentals	44,826
Taxi	4,555
Other ground transportation	47,660
Off-Airport rental cars and other groundside	2,242
Ground and Building Rentals	5,554
Traffic fines & forfeitures	112
Total Ground Transportation and Parking	\$202,783
<b><u>Other Leased Areas</u></b>	
Hotel	-
<b>Total Concession Revenues</b>	<b>\$305,155</b>
Annual Service Payment percentage	15.00%
	<b>\$45,773</b>

Note: Amounts may not add due to rounding.

**Attachment 3****CALCULATION OF TERMINAL AREA RENTALS AND RENTAL SURCHARGE****(BASIC RENTAL ADJUSTMENT)****SAN FRANCISCO INTERNATIONAL AIRPORT**

Fiscal Year 2023/24

(dollars in thousands, except for rates)

	Pro Forma 2024
<b><u>Terminal Area Expenses</u></b>	
Operation and Maintenance Expenses	\$ 390,267
Debt Service	453,436
Small Capital Outlays	2,699
Equipment	1,185
Annual Service Payment	45,773
Annual ORCIF Deposit	196,844
Deferred Aviation Revenue	(196,844)
	<u>\$ 893,360</u>
÷ 'Gross Terminal Space (square feet)	5,916
= Basic Rate	\$151.02
x Airline Leased Space (square feet)	<u>1,742</u>
<b>= Basic Rentals</b>	<b>[A] \$ 263,048</b>
<b><u>Rental Surcharge (Basic Rental Adjustment)</u></b>	
Basic Rate	\$151.02
x Public Space	<u>4,174</u>
= Cost of Public Space	\$630,312
- Non-airline revenues	(175,077)
- PFCs Classified as Revenues	(150,000)
+ Net Expense - GT and Parking Area	-
Rental Surcharge	<u>\$ 305,236</u>
<b><u>Allocation of Rental Surcharge (Basic Rental Adjustment)</u></b>	
Terminal Area Rental Surcharge	<b>[B] \$ 152,618</b>
Landing Fee Surcharge	<u>152,618</u>
	305,236
<b><u>Terminal Area Rentals</u></b>	
Basic Rentals	<b>[A] \$ 263,048</b>
Terminal Area Rental Surcharge	<b>[B] 152,618</b>
	<u>\$ 415,666</u>
<b><u>Effective Average Rental Rate</u></b>	
Basic Rate	\$151.02
Rental Surcharge Rate	<u>87.62</u>
	\$238.63

Note: Amounts may not add due to rounding.



**Attachment 4****DERIVATION OF REQUIRED AIRLINE RENTAL RATE STRUCTURE****SAN FRANCISCO INTERNATIONAL AIRPORT**

Fiscal Year 2023/24

(dollars in thousands, except for rates)

	Pro Forma 2024
<b>Airline Leased Space (square feet)</b>	
Category I	321
Category II	552
Category III	195
Category IV	633
Category V	40
	1,742
	Relative value
<b>Equivalent Category I (square feet)</b>	
Category I	1.00      321
Category II	0.75      414
Category III	0.50      98
Category IV	0.25      158
Category V	0.10      4
	995
<b>Required Category I</b>	
Terminal Area Rentals	\$ 415,666
Divided by Equivalent Category I space (square feet)	995
Required Category I Rate (per square foot)	\$417.58

<b>Terminal Rental Rates</b>	Relative value	
Category I	1.00	\$417.58
Category II	0.75	313.19
Category III	0.50	208.79
Category IV	0.25	104.40
Category V	0.10	41.76

Note: Amounts may not add due to rounding.

**Attachment 5****CALCULATION OF LANDING FEES AND LANDING FEE RATE****SAN FRANCISCO INTERNATIONAL AIRPORT**

Fiscal Year 2023/24

(dollars in thousands, except for rates)

	Pro Forma 2024
<b><u>BASIC LANDING FEES</u></b>	
Operation and Maintenance Expenses	\$105,388
Debt Service	43,403
Small Capital Outlays	460
Equipment	671
Annual ORCIF Deposit	53,156
	<u>\$203,077</u>
Non-airline revenues	(4,616)
PFCs Classified as Revenues	(1,000)
Deferred Aviation Revenue deficit (surplus)	(53,156)
Net expense (revenue) - Other Leased Areas	3,115
Net expense (revenue) - West of Baysshore Area	2,471
	<u>\$149,891</u>
<b>Airfield Area Net Expense</b>	<b>\$149,891</b>
÷ Composite landed weight forecast (in 1,000 lbs units)	36,050
	<u>\$4.16</u>
<b><u>LANDING FEE SURCHARGE</u></b>	
Landing Fee Surcharge	\$ 152,618
Net revenue - GT and Parking Area	(52,048)
	<u>\$ 100,570</u>
÷ Composite landed weight forecast (in 1,000 lbs units)	36,050
	<u>\$2.79</u>

<b>Landing Fees</b>	
Basic Landing Fees	\$ 149,891
Landing Fee Surcharge	100,570
	<u>\$ 250,461</u>
<b>Landing Fee Rate</b>	
Basic Rate	\$4.16
Surcharge Rate	2.79
	<u>\$6.95</u>

Note: Amounts may not add due to rounding.

**EXHIBIT P  
FORM OF ACTIVITY REPORT**

**[ATTACHED]**

## San Francisco International Airport - Monthly Air Traffic Activity Report (MATAR)

Month/Yr	
Air Carrier	<b>Example Airlines</b>
Operating for	Example Airlines
Category	[See DescriptionSheet]
Lease/Permit	[Lease/Permit No.]

### Revenue and Non-Revenue Passenger Data Summary

Geographic Region	Passenger Category	Terminal 1			International Terminal			Total
		Boarding Area C			Boarding Area A			
		Enplaned Count	Deplaned Count	In-Transit Count	Enplaned Count	Deplaned Count	In-Transit Count	
US Domestic	Revenue							
	Non-Revenue							
	Total							
Asia	Revenue							
	Non-Revenue							
	Total							
GRAND TOTAL	Revenue							
	Non-Revenue							
	Total							

### Cargo Data Summary

Geographic Region	Type of Cargo	Pax Aircraft		Freighter Aircraft		Combi Aircraft		Total		
		Enplaned (Outbound)	Deplaned (Inbound)	Enplaned (Outbound)	Deplaned (Inbound)	Enplaned (Outbound)	Deplaned (Inbound)	Enplaned (Outbound)	Deplaned (Inbound)	Total Weight (lbs)
		Weight (lbs)	Weight (lbs)	Weight (lbs)	Weight (lbs)	Weight (lbs)	Weight (lbs)	Weight (lbs)	Weight (lbs)	
US Domestic	Mail									
	Express									
	Freight									
	Total									
Asia	Mail									
	Express									
	Freight									
	Total									
GRAND TOTAL	Mail									
	Express									
	Freight									
	Total									

### Revenue Landing Activity Summary

A/C Model										
A/C Type	▼	▼	▼	▼	▼	▼	▼	▼	▼	▼
Max. Landing Wt. (lbs)										
Geographic Region	No. of Landings by Corresponding A/C Model (above)									Total
US Domestic										
Asia										
GRAND TOTAL										
Total Domestic Landing Wt. (lbs)										
Total Int'l Landing Wt. (lbs)										
GRAND TOTAL Landing Wt. (lbs)										

### Non-Revenue Landings

Total

Completed by: \_\_\_\_\_  
 Email \_\_\_\_\_  
 Certified Correct  
 (Name, Title, Telephone)

### Jet Bridge Usage Activity (if required to report)

Gate #							
Usage							
Total							

**SUBMIT REPORT BY THE 10TH OF EACH MONTH**  
 TO >>> [MATAR@flysfo.com](mailto:MATAR@flysfo.com)  
 TELEPHONE >>> **650-821-2879**

## EXHIBIT Q FORM OF CAPITAL PROJECT REVIEW FORM

SAN FRANCISCO INTERNATIONAL AIRPORT							
CAPITAL PROJECT REQUEST AND REVIEW FORM - FY2010/11							
Project Title: [Project Title]						Proj. Mgr: [PM Name]	
FAMIS No.	Select FAMIS Project	SFO Project No.	[Airport Project No]	Primary Contract No.:	[Enter Primary Contract Number]	Phone No.:	[Phone Number]
Division:	Select Division	Section:	[Enter Section]	Date:	[Enter Date]	Deputy Approval:	Select Deputy Director
<b>PROJECT DESCRIPTION</b>							
[Provide a brief paragraph describing the purpose of the project, location of the project, and the significance of the project's benefits relative to the Airport.]							
<b>EVALUATION CRITERIA (to be completed by CPRC)</b>						<b>PROJECT STATUS</b>	
Project Rank:					In Capital Plan?	Yes	
Project Score:						No	
						Total Project Cost:	\$ -
						Capital Plan Funded Amount:	\$ -
						Unfunded Balance:	\$ -
<b>BUSINESS CASE</b>							
A. Project justification:	[Provide reasons why the Airport should undertake this project]						
B. Consequences if project not done:	[Provide information about what will happen if the project is not undertaken]						
C. Project alternatives:	[Provide workable alternatives that might be undertaken in lieu of the project]						
D. Reason for increase in cost from current approval:	[Provide reasons why the project cost has increased]						
G. Useful Life (Yrs):	[Estimate the useful life of the asset once it is completed and/or activated]						
<b>PROJECT EXPENDITURES</b>							
Contract No. and Title	FY10/11	FY11/12	FY12/13	FY13/14	FY14/15	YEARS 6-10	TOTAL PROJECT COST
Contract No & Title	\$ -	\$ -	\$ -	\$ -	\$ -	\$ -	\$ -
Contract No & Title	\$ -	\$ -	\$ -	\$ -	\$ -	\$ -	\$ -
Contract No & Title	\$ -	\$ -	\$ -	\$ -	\$ -	\$ -	\$ -
Contract No & Title	\$ -	\$ -	\$ -	\$ -	\$ -	\$ -	\$ -
Contract No & Title	\$ -	\$ -	\$ -	\$ -	\$ -	\$ -	\$ -
<b>Total Amount</b>	<b>\$ -</b>	<b>\$ -</b>	<b>\$ -</b>	<b>\$ -</b>	<b>\$ -</b>	<b>\$ -</b>	<b>\$ -</b>
<b>PROJECT SCHEDULE</b>						<b>SOURCES OF FUNDS</b>	
	Start		Finish				
	Estimated	Actual	Estimated	Actual			
Planning & Design	[Month - Year]	[Month - Year]	[Month - Year]	[Month - Year]	Bond Funds:	\$ -	
Construction	[Month - Year]	[Month - Year]	[Month - Year]	[Month - Year]	Passenger Facility Charge (PFC) Funds:	\$ -	
Project In Service Date	[Month - Year]	[Month - Year]	[Month - Year]	[Month - Year]	Operating Funds (including FM):	\$ -	
					Grant Funds:	\$ -	
					Other:	\$ -	
					<b>Total:</b>	<b>\$ -</b>	
<b>USES OF FUNDS</b>							
	Previously Budgeted	Requested Appropriation	Requested Yr 1-5	Requested Yr 6-10	Grand Total		
<b>External Costs</b>							
10 Construction	\$ -	\$ -	\$ -	\$ -	\$ -		
55 Professional Services	\$ -	\$ -	\$ -	\$ -	\$ -		
<b>Subtotal</b>	<b>\$ -</b>	<b>\$ -</b>	<b>\$ -</b>	<b>\$ -</b>	<b>\$ -</b>		
<b>Internal Costs</b>							
11 Reprographics	\$ -	\$ -	\$ -	\$ -	\$ -		
15 Equipment	\$ -	\$ -	\$ -	\$ -	\$ -		
16 ITT	\$ -	\$ -	\$ -	\$ -	\$ -		
25 AE&I Design	\$ -	\$ -	\$ -	\$ -	\$ -		
35 AE&I Inspection	\$ -	\$ -	\$ -	\$ -	\$ -		
40 Maintenance	\$ -	\$ -	\$ -	\$ -	\$ -		
65 Interdepartmental Work Order	\$ -	\$ -	\$ -	\$ -	\$ -		
75 Airfield Escorts	\$ -	\$ -	\$ -	\$ -	\$ -		
AE Art Enrichment	\$ -	\$ -	\$ -	\$ -	\$ -		
OH Overhead	\$ -	\$ -	\$ -	\$ -	\$ -		
<b>Subtotal</b>	<b>\$ -</b>	<b>\$ -</b>	<b>\$ -</b>	<b>\$ -</b>	<b>\$ -</b>		
<b>Total Project Cost</b>	<b>\$ -</b>	<b>\$ -</b>	<b>\$ -</b>	<b>\$ -</b>	<b>\$ -</b>		
<b>CASH FLOW PROJECTIONS AND FISCAL IMPACT</b>							
	FY 10/11	FY 11/12	FY 12/13	FY 13/14	FY 14/15	Years 6-10	TOTAL PROJECT COST
Cash Requirements (-)	\$ -	\$ -	\$ -	\$ -	\$ -	\$ -	\$ -
Grant Collections (+)	\$ -	\$ -	\$ -	\$ -	\$ -	\$ -	\$ -
Incr (-) or Decr (+) in O&M Costs	\$ -	\$ -	\$ -	\$ -	\$ -	\$ -	\$ -
Revenue Increase (+)	\$ -	\$ -	\$ -	\$ -	\$ -	\$ -	\$ -
<b>Net Cash Flow</b>	<b>\$ -</b>	<b>\$ -</b>	<b>\$ -</b>	<b>\$ -</b>	<b>\$ -</b>	<b>\$ -</b>	<b>\$ -</b>
<b>Net Present Value</b>							

## EXHIBIT R

### EXAMPLE OF CALCULATION OF ANNUAL ORCIF DEPOSIT AND ALLOCATION TO COST CENTERS

**EXHIBIT R****CALCULATION OF AIRPORT OPERATING RESERVE AND CAPITAL INVESTMENT FUND DEPOSITS AND COST CENTER ALLOCATION**

SAN FRANCISCO INTERNATIONAL AIRPORT

(dollars in thousands)

(Fiscal Years Ending June 30)

		Forecast									
		2024	2025	2026	2027	2028	2029	2030	2031	2032	2033
<b>CALCULATION OF MINIMUM AND MAXIMUM ORCIF DEPOSITS AND MAXIMUM BALANCE</b>											
Minimum Annual ORCIF Deposit in 2024 Dollars		\$0	\$25,000	\$25,000	\$25,000	\$25,000	\$30,000	\$30,000	\$30,000	\$30,000	\$30,000
Applicable Index from FY 2024			102.00%	104.00%	104.00%	104.00%	104.00%	104.00%	104.00%	104.00%	104.00%
Indexed Minimum Annual ORCIF Deposit	[A]	\$0	\$25,500	\$26,000	\$26,000	\$26,000	\$31,200	\$31,200	\$31,200	\$31,200	\$31,200
Additional Annual ORCIF Deposit in 2024 Dollars		\$250,000	\$70,000	\$60,000	\$50,000	\$40,000	\$30,000	\$25,000	\$25,000	\$0	\$0
Applicable Index from FY 2024			102.00%	104.00%	106.00%	108.00%	110.00%	112.00%	114.00%	116.00%	118.00%
Indexed Additional Annual ORCIF Deposit	[B]	\$250,000	\$71,400	\$62,400	\$53,000	\$43,200	\$33,000	\$28,000	\$28,500	\$0	\$0
Indexed Maximum Annual ORCIF Deposit	[A+B=C]	\$250,000	\$96,900	\$88,400	\$79,000	\$69,200	\$64,200	\$59,200	\$59,700	\$31,200	\$31,200
Maximum uncommitted balance in ORCIF in 2024 Dollars		\$650,000	\$650,000	\$650,000	\$650,000	\$650,000	\$650,000	\$650,000	\$650,000	\$650,000	\$650,000
Applicable Index from FY 2024			102.00%	104.00%	106.00%	108.00%	110.00%	112.00%	114.00%	116.00%	118.00%
Indexed maximum uncommitted balance in ORCIF	[D]	650,000	663,000	676,000	689,000	702,000	715,000	728,000	741,000	754,000	767,000
<b>REQUIREMENT</b>											
Beginning Balance Exclusive of Interest Earnings		\$0	\$250,000	\$346,900	\$435,300	\$514,300	\$583,500	\$647,700	\$706,900	\$766,600	\$766,600
Cumulative Interest Earnings		1,250	4,996	9,947	17,219	25,710	36,933	49,432	63,191	77,712	92,760
Annual ORCIF Deposit		250,000	96,900	88,400	79,000	69,200	64,200	59,200	59,700	0	31,200
Encumbrances and allocations											
Ending Balance		\$251,250	\$351,896	\$445,247	\$531,519	\$609,210	\$684,633	\$756,332	\$829,791	\$844,312	\$890,560
<b>Allocation of Annual ORCIF Deposit by Cost Center<sup>1</sup></b>											
Airfield		\$53,156	\$25,500	\$26,000	\$26,000	\$26,000	\$31,200	\$31,200	\$31,200	\$0	\$31,200
Terminal		196,844	71,400	62,400	53,000	43,200	33,000	28,000	28,500	-	-
GT and Parking											
Other Leased Areas											
West of Bayshore											
		\$250,000	\$96,900	\$88,400	\$79,000	\$69,200	\$64,200	\$59,200	\$59,700	\$0	\$31,200

Note: Amounts may not add due to rounding.

<sup>1</sup>The Minimum Annual ORCIF deposit will be allocated to the Airfield Area Cost Center. Additional Annual ORCIF Deposits will be allocated as follows:

- a. Deposits allowable from Deferred Airline Revenue will be allocated between the Airfield Area and the Terminal Area based on the pro rata share of expenses.
- b. Deposits allowable from PFCs Designated as Revenues will be allocated to the Terminal Area.